

NASA Armstrong Flight Research Center's Contributions to the Space Shuttle Program



Edited by Christian Gelzer



Library of Congress Cataloging-in-Publication Data

Names: Gelzer, Christian, 1957- editor. | NASA Neil A. Armstrong Flight Research Center, issuing body.

Title: NASA Armstrong Flight Research Center's contributions to the space shuttle program / Christian Gelzer, editor.

Other titles: NASA SP (Series) ; 4322.

Description: Edwards, CA : National Aeronautics and Space Administration, Armstrong Flight Research Center, [2021] | Series: NASA SP ; 2020-4322 | Includes bibliographical references. | Summary: "A history of NASA Armstrong Flight Research Center's role in the Space Shuttle program"-- Provided by publisher.

Identifiers: LCCN 2021014195 (print) | LCCN 2021014196 (ebook) | ISBN 9781626830639 (paperback) | ISBN 9781626830646 (Adobe pdf)

Subjects: LCSH: NASA Neil A. Armstrong Flight Research Center--History. | Space shuttles--United States--History. | Astronautics--United States--History.

Classification: LCC TL795.5 .N368 2021 (print) | LCC TL795.5 (ebook) | DDC 629.4410973--dc23 | SUDOC NAS 1.21:2020-4322

LC record available at <https://lcn.loc.gov/2021014195>

LC ebook record available at <https://lcn.loc.gov/2021014196>

NASA Armstrong Flight Research Center's Contributions to the Space Shuttle Program

Christian Gelzer, Editor

We demonstrated that a winged vehicle could fly into space, return through the atmosphere without breaking or burning up, and land at a pre-determined spot.

**Joseph A. Walker, X-15 pilot
NASA Flight Research Center
1962**

Table of Contents

Acknowledgements	II
Contextual Timeline	III
Introduction	
1. The Foundation— <i>Christian Gelzer</i>	1
2. Supersonic Flight— <i>Curtis Peebles</i>	12
3. Turning into the Wind— <i>Christian Gelzer and Curtis Peebles</i>	17
Development	
4. Development of Reaction Control Systems— <i>Christian Gelzer</i>	29
5. Lifting Bodies and Low L/D Research— <i>Peter W. Merlin</i>	43
6. Free Enterprise: The Approach and Landing Test Program and Development of the Space Shuttle Orbiter— <i>Peter W. Merlin</i>	57
7. Thermal Protection System and the Flight Loads Laboratory— <i>Christian Gelzer</i>	64
8. Early Shuttle Thermal Protection System Tests on F-104 and F-15 Testbed Aircraft— <i>Gray Creech</i>	69
Operations	
9. NASA 25: The Convoy Commander’s Vehicle— <i>George Grimshaw</i>	81
10. Edwards Air Force Base and Shuttle Landings— <i>Christian Gelzer</i>	91
11. The Airdocs’ Perspective— <i>Richard Shih-Shien Chou</i>	98
12. The Orbiter Mock-up— <i>Michael R. Chandler</i>	103
Troubleshooting	
13. Enterprise: Pilot-Induced Oscillation— <i>Peter W. Merlin</i>	110
14. Shuttle Tire Tests— <i>Christian Gelzer and Christopher Nagy</i>	119
15. Lifting Insulating Foam Trajectory Project (LIFT)— <i>Gray Creech</i>	136
Conclusion	
16. Conclusion— <i>Christian Gelzer</i>	145
Appendix A	148
Sources	151
Contributors	174

Acknowledgements

In an attempt to recognize the decades of work at the Armstrong Flight Research Center (AFRC) related to NASA's space shuttle program—direct and indirect—I have relied on the participation, support, advice, and guidance of many people, without whom this project would not have succeeded.

George Grimshaw, the Armstrong Shuttle Project and Operations Manager, endorsed this and its sister oral history project from the start; it was he who made both possible.

Without my co-authors, Peter Merlin, Curtis Peebles, Gray Creech, George Grimshaw, Chris Nagy, Michael Chandler, and Richard Shih-Shien Chou, this project would have been stillborn. Dennis Jenkins offered support and answers on myriad things shuttle related, generously digging through his material and contacting others to supplement what he has. His direct participation in the shuttle program was invaluable to me, as has been his counsel. My thanks extend to colleagues at NASA's Johnson Space Center: Dr. Jennifer Ross-Nazzal hunted down answers to questions and images and also read and commented on the manuscript, while Rebecca Wright and Sandra Johnson conducted interviews on which I relied. Their collective work forms the bulwark of NASA's stupendous oral history collection. Al Bowers devoted a great deal of time to ensure that I understood aeronautics beyond what textbooks can explain and teach. William Guoan read and commented on the manuscript. And I am indebted beyond measure to Elizabeth Kissling at Armstrong, who edited this manuscript: she improves whatever she touches. Karl Bender and Kaylynn Clark were patient and endlessly helpful finding reports that I could not, without which I would not have managed this job. Karl's knowledge of NASA and especially the NACA institutional history has been the source of many entertaining conversations. And I am deeply grateful to my peer reviewers, who critically examined the text, made valuable recommendations, and held me to account. This is a stronger book because of their participation.

When I first broached this project I enjoyed the endorsement of Kevin Rohrer, Armstrong's Chief of Strategic Communications, and the support of Steve Lighthill, head of Visual Communications when I went to Grimshaw to propose the idea. Steve and I have produced a number of books together; his voice and experience were essential. Armstrong's photo lab provided exquisite imagery, as it always has; the Center's photographers are peerless.

It is common to assume that if someone claims a link to a given flight project at the Center it is a direct one, such as a pilot, crew chief, or engineer. It's not surprising, since these are visible jobs with tangible links to the project. Yet when we think this way we tend to overlook all behind the scenes who made a flight possible - including flight planners, safety personnel, life support personnel, electronics technicians and fabrication specialists, mechanics, and many other disciplines. This mindset even ignores all who worked for years on a project's antecedents, without which the one at hand would not have happened. Take for example those who worked on the first-generation X-planes, from the X-1s to the X-15s - programs that laid the foundation for the space shuttle program. From these programs came experience with rocket plane propulsion and energy management, familiarity with aircraft that left Earth's atmosphere and flew back to a landing, Reaction Controls Systems, lifting bodies and very low lift-to-drag ratios, fly-by-wire aircraft, high altitude life support and more. As the early chapters make clear, it was this Center, because of its diverse experiences over the its first decade-and-a-half of existence, that served as the template for the new agency—NASA—and its new mission—space—which eventually led to the space shuttle. That experience rests in people and what they passed along to subsequent generations.

Dr. Christian Gelzer
Historian
Logical Innovations, Inc.
NASA Armstrong Flight Research Center
Edwards, California

Contextual Timeline

First gas turbine-powered aircraft flight (Heinkel He 178): August 27, 1939
Mach 1: October 14, 1947 (Bell X-1)
First gas turbine-powered airliner flight: July 27, 1949 (de Havilland Comet 1)
Mach 2: November 20, 1953 (Douglas D-558-II)
Mach 3: September 27, 1956 (Bell X-2)
Sputnik I: October 4, 1957
First Reaction Control Systems flight test: November 27, 1957 (Bell X-1B)
First human in space: April 12, 1961 (Yuri Gagarin)
Mach 5: June 23, 1961 (North American Aviation X-15)
X-15 reaches space: July 17, 1962
First lifting body free-flight: August 16, 1963 (NASA M2-F1)
First supersonic airliner flight: June 5, 1969 (Tupolev Tu-144)
Apollo 11 astronauts land on the moon: July 20, 1969
Space Transportation System (space shuttle) commitment: January 5, 1972
Launch of last Apollo moon mission: December 7, 1972
Last spaceflight of an American astronaut until the shuttle*: July 17, 1975
Last powered, piloted, lifting body flight: September 23, 1975 (Martin Marietta X-24B)
Approach and Landing Tests (space shuttle): February 15-October 26, 1977
First shuttle spaceflight (Columbia): April 12, 1981
Loss of Challenger: January 28, 1986
Loss of Columbia: February 1, 2003
Last shuttle launch (Atlantis): July 8, 2011
First privately-funded lifting body free-flight (SNC Dream Chaser): October 26, 2013

* Apollo-Soyuz Test Program

The NASA Armstrong Flight Research Center has had nine names since its creation; this manuscript spans seven of them. For clarity's sake I have imposed the term "Flight Research Center" or "Center" on the text as that is the most common naming element throughout the Center's history. I apologize for the historical discontinuity this creates, but as the following accounts move back and forth through time I felt it best to use a consistent naming convention.

September 15, 1946: No name. The first two NACA* engineers arrive at Muroc Army Airfield.
September 7, 1947: Muroc Flight Test Unit
November 14, 1949: NACA High-Speed Flight Research Station
July 1, 1954: NACA High-Speed Flight Station
October 1, 1958: NASA† High-Speed Flight Station
September 27, 1959: NASA Flight Research Center
March 26, 1976: NASA Dryden Flight Research Center
October 1, 1981: NASA Ames-Dryden Flight Research Facility
March 1, 1994: NASA Dryden Flight Research Center
March 1, 2014: NASA Armstrong Flight Research Center

*NACA: the National Advisory Committee for Aeronautics, 1915-1958

†NASA: National Aeronautics and Space Administration, 1958-present

Introduction

1: The Foundation

Christian Gelzer
Logical Innovations, Inc.
NASA Armstrong Flight Research Center

Abstract:

In 1945 the National Advisory Committee for Aeronautics (NACA) joined the U.S. Army Air Forces in the post-war quest for supersonic flight. The NACA pursued transonic data on its own using another aircraft. Although initially unprepared for the challenge, the small NACA group at Muroc/Edwards AFB rose to the task, developing the technical corpus to lead the U.S. to space.

Keywords:

Transonic; Supersonic; R. T. Jones; Theodore Theodorsen; Adolph Busemann; Swept wing; Ludwik Fleck; Thomas Kuhn

In the final years of WWII it became apparent to a few key American observers that a revolution in flight was at hand. Several types of propeller aircraft were experiencing the effects of transonic flight by then, and even before war's end the Germans and the British had flown jet powered aircraft operationally, "signposts of the future" U.S. Army Air Forces [AAF] Gen. Henry H. "Hap" Arnold called them.¹

Ahead lay piloted supersonic flight.

At this pivotal juncture in aeronautical history stood the United States' National Advisory Committee for Aeronautics (the NACA), ideally suited for this revolution in flight technology—in theory—but largely unprepared temperamentally, culturally, and experientially.² This unpreparedness became especially evident when the NACA partnered with the AAF on the X-1 project. Designed to fly in a regime where no piloted aircraft had yet been, Bell Aircraft Corporation's X-1 would operate by new aerodynamic rules and make new demands on its pilots, ground crews, flight planners, and researchers.³ Yet, even after committing to the first major flight research project in more than a decade and despite their combined brilliance, experience, and discoveries, John Stack, Walter Williams, Melvin Gough, and Hartley Soulé (all of the NACA's Langley Aeronautical Memorial Laboratory, VA) did not see the aircraft chosen for the task as fundamentally different from the early aircraft with which the NACA began its flight research, or from the Lockheed P-80 and

¹ Observers in Europe noted this as well, of course. Lockheed pilot Ralph Virden died in November 1941 when he was unable to recover from a dive in a P-38 as it flew into the transonic realm. It was not the only aircraft type to encounter this phenomenon. Engineers at the NACA Langley Memorial Aeronautical Laboratory tackled the problem in the High-Speed Tunnel and proposed a special flap on the underside of the wing of the P-38; additional testing at the NACA Ames Research Center in Moffett Field, CA, confirmed this solution. James R. Hansen, *Engineer in Charge: A History of the Langley Aeronautical Laboratory, 1917-1958*, (Washington, D.C.: NASA, 1987), p. 250, citing Clarence L. Johnson, "Investigation of Tail Buffeting Conditions on Lockheed P-38 Airplane," Lockheed Report No. 2414, September 23, 1941, in 1105/Lockheed, LaRC Technical Library. Both the British Gloster Meteor and the Messerschmitt Me 262 entered service in mid-1944. H. H. Arnold, "Air Force in the Atomic Age," in Dexter Masters and Katharine Way, eds. *One World or None*, (New York: McGraw, Hill Co., Inc., 1946), p. 30. Michael H. Gorn, "The NACA and its Military Patrons in the Supersonic Era, 1940-1958," *Air Power History*, Fall 2011, pp. 16-27. Army Air Corps: 1926-1941; Army Air Forces: 1941-1947.

² Unlike NASA, the NACA is an initialism, not an acronym.

³ Engineer and historian Dennis Jenkins points out that even the shift to jet powered aircraft involved a technological transition few appreciated at the time. In the fall of 1947 North American Aviation (NAA) delivered the first example of the XP-86 fighter jet to Muroc Army Airfield (Edwards AFB today) for testing. Before it flew, the aircraft underwent a series of ground tests, including engine runs. During the runs an NAA mechanic walked from one side of the aircraft to the other, passing in front of the jet. In doing so he came too close to the engine inlet at the nose, was sucked in, and died miserably. The NAA mechanic was neither inexperienced nor foolish. Like everyone else in the day, the mechanic was very familiar with what to watch for in the case of piston engines and spinning propellers: one learned quickly how to avoid becoming known as "Lefty," or worse. But the turbojet was a new technology, something few if any fully understood. The mechanic may have known enough to be careful of the hot exhaust blast of the jet engine coming out the back of the XP-86, given that he passed in front of, not behind, the aircraft, but there was nothing apparently dangerous about the front of the airplane; there was no 11 foot diameter windmill to cut off his arm - only a small hole in the nose that seemed to suck air like a vacuum cleaner. Dennis R. Jenkins and Tony R. Landis, *Experimental & Prototype U.S. Air Force Jet Fighters*, (Cape Canaveral, FL: Dennis R. Jenkins, 2008), p. 87. There are other examples similar to this of very experienced piston engine / propeller aircraft pilots who, despite advice, seemed to treat the new technology the same way as the old and familiar, and who died as a consequence.

Republic P-84 then in use for high-speed research at Langley. Even after early X-1 glide flights at Pinecastle, FL were complete (but before rocket-powered flights began at Muroc Army Airfield, CA), senior NACA officials were still determined to fly the airplane from Langley's runway, a site patently unsuited for this aircraft and its flight regime.⁴

The Agency's unpreparedness was evident in more than plans. Stack, for example, was so frustrated at the inability to control all the events and specifics surrounding the X-1 that he sent a petulant memo to John Crowley, Chief of Research at Langley: "This airplane originated here as did the P-80 program. If we are to do research of this kind we must have the airplane here. I do not believe we should again be treated as a service as was in the case with the P-80. If the shifting of this aircraft to a western station materializes I propose that we transfer *all work* beginning right now so we can free our people to do research with our present equipment." [sic] Gough, Langley's chief pilot, was equally unhappy about how events were unfolding and just as trenchant as Stack. Langley engineer John Becker attended a meeting at Wright Field, OH where the AAF gathered the parties to discuss the X-1 and noted: "Mel Gough condemned the rocket airplane. 'No NACA pilot will ever be permitted to fly an airplane powered by a damned firecracker.'"⁵

Although the NACA was critical to the X-1 research project, Stack and his colleagues overlooked several things, not least of which was that the AAF had a contract with Bell for three airplanes at a cost of \$4.278 million in 1945 dollars; the Navy had its own contract with Douglas Aircraft Company for the D-558-I and -II, paying \$6.888 million for six airplanes, all of which the NACA very much wanted access to, if not a lead role with. The Agency itself put no money into these aircraft yet still felt that, after the AAF and the Navy had committed some \$11 million for critical flight research programs with the Cold War in the offing amidst declining military budgets, both branches of the military would be willing to wait a *decade* to reach Mach 1.⁶

Not surprisingly, frustration and even acrimony passed between the NACA and its military partners. The mood had been welling for some time. In 1938, General "Hap" Arnold, Chief of the Army Air Corps (not yet the AAF), asked the NACA Director George Lewis why the U.S. military did not have aircraft that could fly 400 mph (644 km/hr) which Charles Lindbergh reported the Germans had. When Lewis admitted that he'd known for some time such speed was possible, Arnold, already angry with him and the NACA, blurted, "Why in the name of God?" - unable to fathom how Lewis could recognize the significance of such potential yet not direct the Agency to investigate it. Lewis replied that the NACA "had always responded to—and could not be

⁴ The failure of Langley engineers to recognize the X-1 as fundamentally different from what they were familiar with is more than conflating one airplane's performance and requirements with another: it involves cultural and political tensions, as well as a host of other influences. Stack was not alone in his displeasure with research he and Langley could not directly control; this may have clouded better judgement. It's good to keep the Jenkins XP-86 example close.

⁵ NACA memorandum R.A. 1347 from John Stack to John Crowley, June 14, 1945, in Louis Rotundo, *Into the Unknown: The X-1 Story*, (Washington, D.C.: Smithsonian Institution Press, 1994), p. 31. Becker also noted: "Ironically, it was the turbojet-powered D-558-1 which killed a[n] NACA pilot due to engine failure while the X-1's had a good safety record at Edwards. The D-558-1 barely exceeded Mach 0.83 in level flight and was limited to Mach numbers below 1.0 in dives. Even more ironic: it was the transonic and supersonic flight achievements of the rocket-powered X-1 which brought the NACA and Stack a share of the Collier Trophy for 1948." John V. Becker, *The High-Speed Frontier: Case Histories of Four NACA Programs, 1920-1950*, (Washington, D.C.: NASA, 1980), p. 163.

⁶ For costs of the two types of research aircraft, see Rotundo, *Into the Unknown*, p. 26. In the context of budget cuts following the end of WWII and congressional criticism of the NACA for "timidity" when compared to the advances made by the British, and especially the Germans, evidence of which publicly surfaced following the war and which the Agency itself was already aware of in some fashion, the Agency's stance can sometimes be confounding. The public accusation of the NACA's "timidity" appeared in the Special Committee investigating the National Defense Program, chaired by Senator James M. Mead. Alex Roland, *Model Research*, Vol. 1, (Washington, D.C.: NASA, SP-4103, 1985), p. 204.

Trying to explain this drubbing, Roland argued that the NACA was in some sense a victim of its own success. "Research equipment shaped the NACA's program fully as much as did its organization and personnel," referring to wind tunnels that were the Agency's tool of success in its first three decades; its "microscope to the biologist" was his metaphor. But the tool became its crutch, so much so that the Agency could not pull itself away from the tunnels when other subjects warranted attention—new propulsion systems, for example. There were personnel issues as well, he argued, which impeded the Agency after early decades of success, factors reflected in the events related here. Roland, *Model Research*, Vol. 1, pp. xiv-xv.

The turbojet was revolutionary in the literal sense, as historian Edward Constant noted, and that by itself required a fundamental change in the way pilots, mechanics, engineers, designers, and flight planners dealt with the aircraft it propelled. This recognition did not come quickly, as the accident toll connected with new aircraft show. That the jump to a rocket plane occurred at virtually the same time as the introduction of the turbojet in the U.S. (excepting the Bell XP-59A/B) did not help an already difficult transition. Edward Constant, II, *The Origins of the Turbojet Revolution*, (Baltimore: Johns Hopkins University Press, 1980); Christian Gelzer, "Casualty White Paper," April 12, 2012, NASA Armstrong Flight Research Center; and Kenneth P. Werrell, "Those Were the Days: Flying Safety During the Transition to Jets, 1944-1953," *Air Power History* (Winter 2005): pp. 40-53.

expected to anticipate—the military’s request for research.” Echoing this, Becker, who worked at Langley in this period, recalled that “there was no real sense of emergency or war peril to motivate a search for radical new weapons or bold new concepts in aircraft.”⁷

It is difficult in the Arnold-Lewis exchange to overlook the NACA’s long, close relationship with both the Navy and what became the Air Force. The agency was created in the midst of the First World War and was closely attuned with U.S. military interests from the start. For many years the Navy hosted the NACA’s headquarters in one of its main Washington, D.C. buildings, and communication was nearly constant with the Army Air Corps in that period. Army Brigadier General George Scriven served as the first chair of the NACA’s executive committee, whose members always included representatives of the Navy and Army. In the 1930s Army and Navy representatives occupied three seats each on the committee—nearly half the committee; similar figures existed for the 1920s, a staffing pattern established at the NACA’s creation. Navy Admiral William Moffett, for one, did not think these positions “honorary, and he actively participated in many of the committee’s policy decisions.”⁸ Moreover, the NACA’s charter specifically called for it to “aid in determining the problems relating to the theoretical study of aerodynamics” and to “endeavor to coordinate, *by counsel and suggestion*, the research and experimental work involved in the investigation of such problems.”⁹

There is no dispute that by 1938 the NACA was struggling to gain appropriate funding for personnel, training and facilities to match what was happening in Europe.¹⁰ On one of the many trips he and others like him on both sides of the Atlantic regularly made after WWI, in 1936 Lewis toured German and Soviet aeronautical facilities and came away deeply impressed with the number of engineers working at key installations and especially the training at German institutions when compared to what the NACA offered—and aeronautics was changing rapidly.¹¹ When Ludwig Prandtl visited the U.S. in 1930 on his return from speaking at a congress of engineers in Japan he stopped at select universities and the NACA’s Langley laboratory and later wrote: “The National Laboratory in Langley Field near Washington (D.C.) is superb, and excellent work is done. Their facilities surpass what we have in Europe.”¹² Six years later, Lewis wrote: “As a result of my visit, I know only too well that unless something is done, within the next year and a half or two

⁷ Dik Daso, “Architects of American Air Supremacy: General Hap Arnold and Dr. Theodore von Karman,” (Ph.D. Dissertation, University of South Carolina, 1996), p. 62, citing correspondence from Charles Lindbergh to H. H. Arnold, November 29, 1938, Air Force Historical Research Agency, pp. 168, 65-40. The Agency’s own 1936 report—based in part on Lewis’ trip to Europe—made clear the growing gap between the U.S. and Europe, especially but not exclusively, vis a vis Germany. See John Jay Ide, “Report on Visit to Germany,” October 23, 1936, Floyd L. Thompson Technical Library, Langley Research Center, Hampton, VA, and Lewis’ “Report on Trip to Germany and Russian [sic], September-October 1936,” E32-12 LCD, cited in Hansen, *Engineer in Charge*, pp. 540-541.

⁸ William F. Trimble, *Admiral William A. Moffett: Architect of Naval Aviation*, (Washington, D.C.: Smithsonian Institution Press, 1994), p. 13. In 1938 both the AAF and the navy’s Bureau of Aeronautics supported congressional funding for a new NACA research center, the Ames Research laboratory. Trimble has a good description of Moffett’s influence on the structure and reach the advisory committee had on the Agency.

⁹ See Roland, *Model Research*, Vol. 2, Appendix F, pp. 532-534, and “National Advisory Committee for Aeronautics,” *Aircraft Journal*, June 28, 1919, Vol. 4, No. 26, p. 9. In 1922, for example, the NACA Advisory Committee members were: Charles D. Walcott, Chair, S. W. Stratton, Sec., Maj. Thurman H. Bane, William F. Durand, John F. Hayford, Rear Adm. William A. Moffett [concurrently the chief of the Navy’s Bureau of Aeronautics], Maj. Gen. Mason M. Patrick, Michael I. Pupin, Rear Adm. D. W. Taylor, and Orville Wright.

¹⁰ Lewis added a warning to the NACA’s 1936 annual report to Congress. Amid descriptions of growing military development and acquisition and particularly Germany’s surge in aeronautical research and development, he pointedly told his readers that “increased recognition abroad of the value and of the vital necessity of aeronautical research has led to recent tremendous expansion in research programs and to multiplication of research facilities by other progressive nations. Thus has the foundation been laid for a serious challenge to America’s present leadership in the technical development of aircraft.” Roger Launius, “Recalling the Great NACA Fact-Finding Trip to Germany in 1936, and its Results,” September 12, 2016, <https://launiusr.wordpress.com/2016/09/12/the-great-naca-fact-finding-trip-to-europe-in-1936-and-its-results/>, accessed June 20, 2018.

¹¹ Albert F. Zahm, “Report of European Aeronautical Laboratories,” July 27, 1914 in Zahm, *Aeronautical Papers*, (2 volumes) (Notre Dame, IN: University of Notre Dame Press, 1950,) Vol.1: pp. 319-342, and Jerome C. Hunsaker, “Europe’s Facilities for Aeronautical Research,” (n.d.). Alex Roland tells us Lewis visited Germany in 1937 (traveling there on the Hindenburg), was hosted by Baeumker, head of aeronautical research in Germany, and was again treated as an important guest (not that he got to see all he might have wanted to). Roland, *Model Research*, p. 147. This was merely a pattern of valuable exchanges. In 1925 Baeumker, a Prandtl and Göttingen colleague, visited the NACA’s Langley facility as part of an official delegation and returned greatly impressed. In 1933 he was appointed Göring’s advisor on aeronautical research and development, wielding extraordinary power. Eckert, *Dawn of Fluid Dynamics*, p. 179-180.

¹² Johanna Vogel-Prandtl, *A Biographical Sketch, Remembrances and Documents*, translated by V. Vasanta Ram, (Trieste: International Centre for Theoretical Physics, 2004), p. 88. The Japanese, he noted, had more wind tunnels than did the Germans.

years the lead in technical development will cross the Atlantic, and probably be taken by Germany.”¹³ In the two years since his tour Lewis and the Agency tried, unsuccessfully, to convince the Congress and the Bureau of Budget “that a crisis was in the making that required a crash program.”¹⁴ (In late 1941 the *Boston Traveler* ran a photospread of airplanes with a sarcastic caption: “When aviation officials announced little more than a week ago that experiments had been held successfully with tail-less planes, the first reaction would seem to indicate that these ships were something new. But the dates on the other ships of this design show that Germany was experimenting with them 12 years ago indicates how well this nation has kep[t] abreast of things aviation.”¹⁵) In this context Arnold’s exasperation with Lewis and the NACA is hardly a surprise.

The fuller story is ironic. In 1934 Germany set out to catch the “Big Powers” (England, Italy, France, and the U.S.) which German leaders felt were eclipsing them and “the primary model for Germany’s expansion in aeronautical research was the USA,” wrote Michael Eckert.¹⁶ Accordingly, German funding for aeronautical research and development rose dramatically. The increase between 1932 and 1939 is breathtaking. The total budget for aeronautical research in 1932 was roughly 3 million Reichmarks, in 1935: 17 million Marks, in 1937: 47 million Marks, and by 1939: 63 million Marks. Prandtl’s AVA at Göttingen saw a budget increase from nearly zero in 1932 to 7 million marks in 1939. In 1930 all of Germany’s aeronautical research employed some 100 people; 300 people in 1935, and 700 in 1940. At the same time, starting in the very early 1920s and running through 1936, the German aeronautical community remained on good terms with the NACA’s Paris Office as well as other NACA members and academia.¹⁷ Prandtl’s team at Göttingen retained high regard for the NACA all the while.¹⁸

In 1942, Langley’s Eastman Jacobs was leading the “Jeep” engine project, “a piston engine driving a compressor” which forced air into a combustion chamber where fuel was admitted, ignited, and exhausted through a nozzle—in essence a variation of the Campini Caproni N.1 powerplant.¹⁹ (The NACA version was meant as propulsion-assist and not primary thrust and when operating correctly it was impressive, burning gasoline at 3-gal./sec., much of it as a large exhaust flame.) The Italian company built and flew two demonstrator aircraft and engines beginning in 1940, which it parked by early 1942 as technologically irrelevant. Becker, on the other hand, described the three-year Jeep project “as a noteworthy exception to the generally conservative pattern” at Langley, and Vannevar Bush, then chairman of the Agency, averred that the Jeep “seems to have great possibilities and I cannot find any flaw in their arguments” in its favor.²⁰ Meanwhile, also in 1942, on the other side of the U.S., Bell Aircraft Company pilot Robert Stanley took off in a Bell XP-59A from the lakebed at the AAF’s Muroc Flight Test Facility (a.k.a. North Base) in California, making it the first American gas turbine powered aircraft to fly (and the first to fly in the U.S.).²¹

¹³ George W. Lewis, “Report on Trip to Germany and Russian [sic], September-October 1936,” undated manuscript, 22 pp., with 10 pp. handwritten notes, in Roland, *Model Research*, notes, p. 358. Lewis estimated one facility alone in Germany employed between 1,600 and 2,000 people compared to Langley’s 350. Roland, *Model Research*, p. 149.

¹⁴ Roland, *Model Research*, p. 147.

¹⁵ *Boston Traveler*, November 4, 1941, p. 31. After the war Theodore von Kármán wrote: “These German achievements are not the result of any superiority in their technical and scientific personnel, but rather due to the very substantial support enjoyed by their research institutions in obtaining expensive research equipment, such as large supersonic wind tunnels, many years before such equipment was planned in this country.” Theodore von Kármán, *Where We Stand, First Report to General of the Army H. H. Arnold on Long Range Research Problems of the AIR FORCES with a Review of German Plans and Developments*, (Scientific Advisory Group: Army Air Forces, August 22, 1945), p. 404.

¹⁶ Michael Eckert, *Dawn of Fluid Dynamics: A Discipline Between Science and Technology*, (Berlin: Wiley-VCH, 2006), pp. 79-88.

¹⁷ In 1936 John Jay Ide, of the NACA, and Clark Millikan of the Guggenheim Aeronautical Laboratory California Institute of Technology (GALCIT) were guests at the German Academy of Aeronautics’ annual meeting (addressed by Göring); Jerome Hunsaker, soon to be chairman of the NACA, and Charles Lindbergh attended the conference the following year. Eckert, *Dawn of Fluid Dynamics*, p. 189.

¹⁸ Eckert, *Dawn of Fluid Dynamics*, pp. 180-186. The change in employment and funding numbers cannot be separated from the Versailles Treaty (1919) and the Great Depression (1929-1939), both of which had a direct impact on German activity in this field; the Depression affected everyone. Germany’s announcement that it was rearming (1935) is also part of this picture.

¹⁹ Becker, *The High-Speed Frontier*, p. 30. Joseph A. Shortal, *A New Dimension: Wallops Island Flight Test Range: The First Fifteen Years*, (Washington, D.C.: NASA, 1978), pp. 8-9. Leadership in the NACA had, by 1936, determined that “about 550 miles per hour was the probably upper limits of airplane speeds.” Becker, *The High Speed Frontier*, pp. 31, 23.

²⁰ Hansen, *Engineer in Charge*, pp. 231-234.

²¹ Hansen, *Engineer in Charge*, p. 227. Later that day, October 2, Col. Laurence Craigie flew the aircraft, becoming the first AAF pilot to fly a jet aircraft. Hallion writes that the first flight unofficially took place October 1, on one engine (the other engine wouldn’t start). Richard P. Hallion, *Test Pilots: The Frontiersmen of Flight*, (Washington, D.C.: Smithsonian Institution, 1981, revised 1988), pp. 169-170. The aircraft used a pair of license-built British Power Jet turbojets for propulsion about which the NACA was entirely unaware. This reflected relations between it and the AAF as much as it did the NACA’s narrow view of things. There is also a degree of self-fulfillment,

Things were slow to improve. In April 1945 Langley aerodynamicist Robert T. Jones submitted for publication his report on swept wings, by which time the Agency already had committed to the X-1

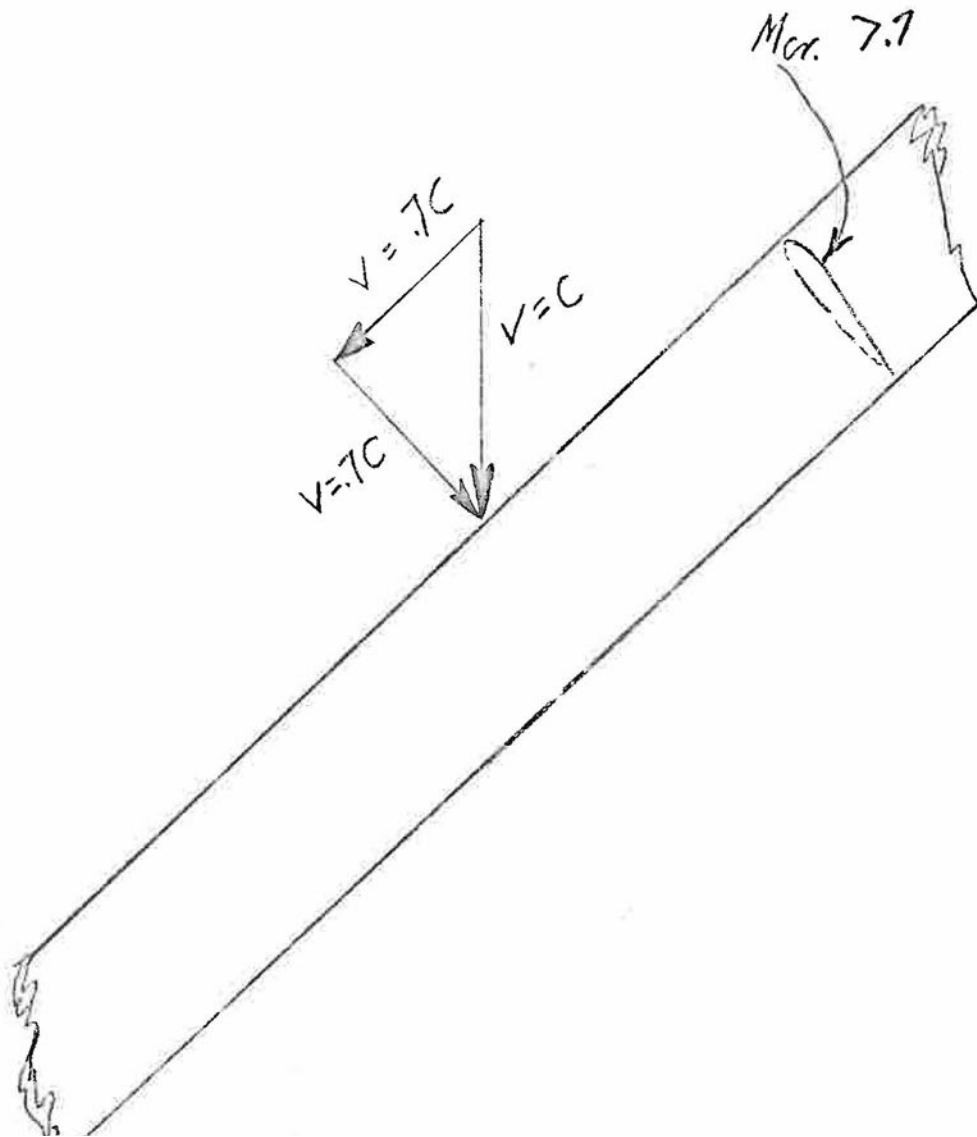

An illustration from R. T. Jones' application for research approval that led to his swept-wing paper in 1945. "C" denotes Mach in this instance.

supersonic test program. Even as he did so, drop tests of scaled models of his concept were under way. "The analysis indicates that for aerodynamic efficiency, wings designed for supersonic speed should be swept back at an angle greater than the Mach angle and the angle of sweep back should be such that the component of velocity normal to the leading edge is less than the critical speed of the airfoil sections," he wrote.²²

inasmuch as the AAF kept the NACA in the dark about its knowledge of and plans for a turbojet. Bush, who became the chairman of the NACA in 1939, head of the National Defense Research Council in 1940, and the director of the Office of Scientific Research and Development in 1941, found himself in an awkward position when, in 1941, Gen. Arnold wrote him calling for research on jet propulsion: he received the letter as chairman of the NDRC, not the NACA. There is no evidence he violated Arnold's confidence. Hansen, *Engineer in Charge*, citing "Hap" Arnold to Vannevar Bush, correspondence February 25, 1941, National Archives Record Group 255.

²² Robert T. Jones, "Report No. 863, "Wing Plan Form for High-Speed Flight," *Collected Works of Robert T. Jones*, (Washington, D.C: NASA TM X-3334, 1976. Report 863 was originally published by Langley in 1945), p. 379. In fact, Sears notes that the peer review committee asked Jones to split the initial report in two so that the committee might approve the first half since it had serious reservations about the second half. Jones did so, leading to Report No. 835's approval (*Properties of Low-Aspect-Ratio Wings at Speeds Below and Above the Speed of Sound*). Despite the arrowhead wing planform featured in the report, No. 835 was not troublesome and Theodorsen edited the final version—in Jones' words, "he contributed a great deal to it." It was the second half that the committee rejected. William P. Sears, Introduction, *Collected Works of Robert T. Jones*, p. x. For a good account of Jones' work on this wing concept see James R. Hansen, *The Bird is on the Wing: Aerodynamics and the Progress of the American Airplane*, (College Station, TX: Texas A&M

Theodore Theodorsen, director of the theoretical division at the Center, one of Langley's senior engineers and a member of the peer review committee, objected to the newest report saying it was "hocus pocus," needed "real mathematics," and that Jones' results were "a snare and a delusion."²³ The peer review committee rejected the paper. To skeptics, wrote William Sears decades later, it seemed "impossible to render

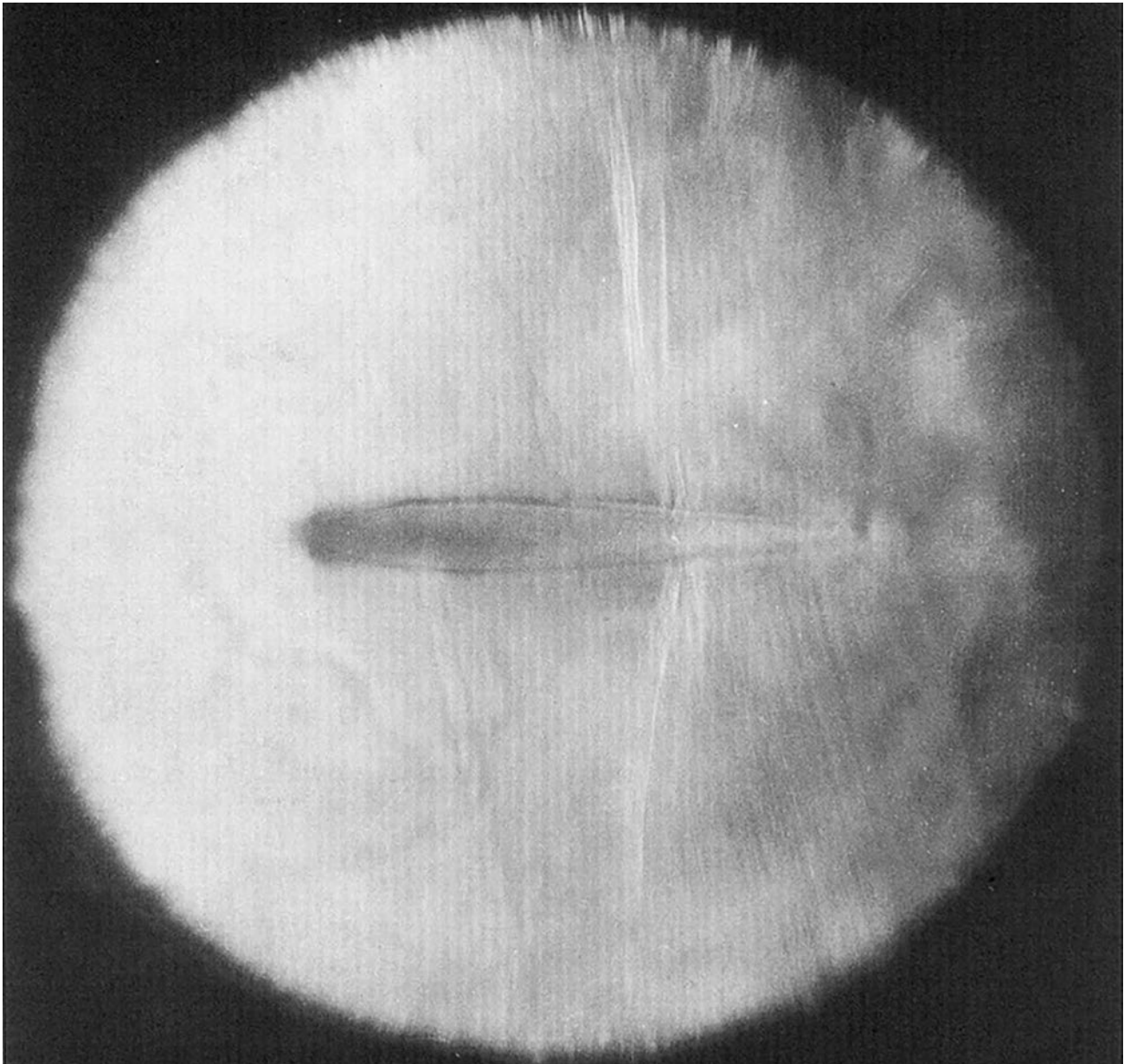

One of the images Eastman presented to the group in Rome, showing shock waves forming in the transonic realm. NASA 4219-077

a supersonic flow essentially subsonic by such a simple device as sweepback."²⁴ *Essentially* is the key word. Sweeping the wing did not slow it to subsonic speed: it made the air treat the wing as if it were moving

University Press, 2004). See also R. T. Jones, letter to Ernest O. Pearson, February 2, 1960, AFRC Historical Reference Collection.

Years later Jones recalled that in 1944 Roger Griswold visited him carrying a model of the Gluhareff-Griswold "Dart." The AAF wanted the NACA's opinion on the concept. "Jones examined the model and studied it on the basis of low aspect ratio. He took the results and stuck them on his desk. Then, after casually perusing some technical papers on supersonic flow, Jones realized he had a low-aspect ratio wing planform that had subsonic flow over the wing." Richard P. Hallion, notes from an interview with Robert T. Jones, July 14, 1977. AFRC Reference Collection. When Griswold visited Jones the concept he was proposing, based on the Dart, was a flying (gliding) bomb he dubbed the "glomb." Richard P. Hallion, notes on "Sweep and Swing: Reshaping the Wing for the Jet and Rocket Age" in *NASA's Contributions to Aeronautics*, Vol. 1, (NASA: Washington, D.C., 2010), pp. 10-11.

²³ Hansen, *Engineer in Charge*, pp. 285-286.

²⁴ Sears, Introduction, *Collected Works of Robert T. Jones*, p. x.

subsonically because the two met at an oblique angle and the most relevant component of the flow velocity remained normal (perpendicular) to the leading edge.

The committee eventually accepted the paper (No. 863) for publication, over Theodorsen's firm objections.²⁵ In time, Jones would be recognized for an array of critical aeronautical contributions, of which the swept wing and its relation to supersonic flight was but the first.

Theodorsen's criticism is perplexing and revealing.

Ten years earlier, in 1935, Jacobs, "one of the most skillful and innovative American aerodynamicists," was invited to present a paper at the Vth Volta Congress, in Rome.²⁶ Sponsored by the Royal Academy of Science and funded by the Volta Foundation, these Congresses gathered extraordinary minds for presentations and discussions, alternating themes each meeting between the sciences and humanities. The first conference (1927) focused on the atom and featured Niels Bohr and Werner Heisenberg and it was at this meeting that Heisenberg revealed his "uncertainty principle." The second Congress had "Europe" as the focus, the third was on "immunology," and the fourth was on "dramatic theater." The 1935 meeting (they occurred at irregular intervals) was titled "High Speeds in Aviation" and Gen. Arturo Crocco, the host, hoped the gathering would close "the existing gap" between the theories of subsonic and supersonic speed. Prandtl made it clear that there was no theory for this area yet. The presenters were recognized leaders in their field, as usual: Ludwig Prandtl, Geoffrey Ingram Taylor, Jacob Ackeret, Adolf Busemann, Theodore von Kármán, and Arturo Crocco, to name but a handful.²⁷ Attendance was by invitation only and the entire group—speakers and guests numbered only 38—gathered in a Renaissance-era villa overlooking the Tiber River. The paper Jacobs presented held startling information he and Stack developed on transonic flight, including the first schlieren photographs of shock patterns and flow separation over a wing, work that genuinely placed the NACA in the van of high-speed flight research.²⁸ His, like all the papers, was sent in ahead of time to be assembled as the proceedings, giving everyone a copy to use during the meeting and to take home. Carlo Ferrari remembered that "signs of the upcoming World War were already apparent during the meeting" but this did not disrupt the exchange of ideas, a point echoed by Busemann: "The days of my attendance to the Volta Congress in 1935 [were] the most interesting part of my life."²⁹ When one thinks of the people in attendance, unlike any before or since—the foundational generation of aeronautics—he had reason to place that time high in his life of memories.

Prandtl spoke about compressibility of fluids at high speeds while von Kármán addressed the rise in drag as fluid compressed; Taylor discussed problems in high speed flow and shock waves (like others, he had photographic illustrations) while Modesto Panetti presented research on convergent-divergent nozzles.

²⁵ After flight research confirmed Jones' assertions a note went to NACA headquarters stating: "Dr. Theodore Theodorsen [still] does not agree with the arguments presented and the conclusions reached and accordingly declined to participate in editing the paper." Hansen, interview with I. E. Garrick, September 24, 1981. "Garrick was a member of [Jones'] editorial committee, as well as a member of Theodorsen's Physical Research Division." Hansen, *Engineer in Charge*, p. 553. Jones, "Report No. 863, Wing Plan Form for High-Speed Flight," *Collected Works of Robert T. Jones*, pp. 379-383, and Hansen, *Engineer in Charge*, pp. 284-285, 379-383. Jones' abilities may have eclipsed his peers at times. Walter Vincenti, one of Jones' colleagues at the NACA/NASA Ames Research Center, noted in his biographical memoir: "Those who worked with R. T. marveled at how he arrived at his ideas, seemingly intuitively and frequently in terms of physical models and analogies. He could use highly sophisticated mathematics deductively when necessary, but he did so mostly to support his ideas and explore their consequences. In the initial report on his concept of sweepback he began conventionally with a mathematical derivation followed by three physical arguments and explanations. *Events at the time suggest that the mathematics actually came to R. T.'s mind after the physical concepts and had been put into the report in response to editorial-committee objections.* [Emphasis added] As [William] Sears wrote, 'Lesser aerodynamicists often find his arguments too concise and the literature of the field includes papers in which authors re-do Bob's work providing longer proofs, and discover again Bob's results.'" Only four pages long, Jones' paper was succinct and to the point. Robert T. Jones, NACA Report No. 863, *Wing Plan Forms for High-Speed Flight*, (Langley, VA: NACA Langley Memorial Laboratory, 1945), Walter Vincenti, "Robert Thomas Jones: May 28, 1910-August 11, 1999," <http://www.nap.edu/readingroom.php?book=biomems&page=rjones.html>, accessed August 19, 2013.

²⁶ R. T. Jones, "Recollections from an Earlier Period in American Aeronautics," *Annual Review of Fluid Mechanics* (1977): pp. 1-11.

²⁷ At least five attendees (von Kármán, Ackeret, Busemann, Maurice Roy, and Gen. Crocco. would go on to be Ludwig Prandtl Ring winners.

²⁸ John Stack, *The Compressibility Burble*, NACA TN 543, (Langley, VA: Langley Memorial Aeronautical Laboratory, 1935). Theodorsen also ridiculed the first schlieren photographs of shock waves at high speeds that Jacobs and Stack produced in the wind tunnel, calling them an "optical illusion." His colleagues did not soon let him forget this: in 1936, Stack himself mocked the pronouncement in a Center Christmas party skit. Becker, *High-Speed Frontier*, p. 16. Jacob's paper: Methods Employed in America for the Experimental Investigation of Aerodynamic Phenomena at High Speeds, in *Convegno di Scienze Fisiche, Matematiche Naturali: Le Alte Velocità in Aviazione, 30 Settembre – 6 Ottobre, 1935-XIII*, (Roma: Reale Accademia D'Italia, 1936-XIV), pp. 369-401.

²⁹ Carlo Ferrari, "Recalling the Vth Volta Congress: High Speeds in Aviation," *Annual Review of Fluid Mechanics*, Vol. 28: 1-9 (Volume publication date January 1996).

Ackeret showed details of a high-speed wind tunnel along with photographs and drawings of a 13-stage axial flow gas turbine compressor for airflow acceleration (with an inter-cooler) and even suggested that “the gas turbine may be applied for an airplane at high altitudes.” (He’d been a Prandtl student at Göttingen where the world’s first blow-down high-speed wind tunnel was built, and would be the first to design and direct the construction of a Mach 2 wind tunnel.³⁰) Maurice Roy talked about research on the principles of “jet” propulsion. It is clear from the exchanges following each presentation that attendees were deeply immersed in the material and not shy about objecting to a conclusion, pointing to “errors” in an assertion, or engaging each other in discussions at the presenter’s expense (“I apologize for having passed a rather quick judgement on Mr. Roy’s remarks in the last meeting [the previous day]. He made an attempt to solve a very important and difficult problem.”) and they asked probing questions that prompted long answers.³¹ Bibliographies at the end of many of the papers show how internationally distributed the discipline’s literature already was.

When it came his turn, Busemann “showed that a configuration with sweptback wings notably improves the aerodynamic characteristics of a [high speed] plane. He also derived the optimal configuration for achieving maximum aerodynamic efficiency gains for a given Mach number.”³² And he had illustrations of a swept wing whose velocity component was “perpendicular” to the leading edge (“Geschwindigkeitskomponente senkrecht”), therefore less than the critical speed of the swept airfoil and his argument, mathematical formula, and explanation were the same as Jones’ ten years later.³³ His remarks should have pulled the delegates forward in their seats: instead, it went almost unremarked.³⁴ (Most of the questions Busemann entertained dealt with his supersonic biplane discussion, which built on Prandtl’s biplane wing theory. The only attendee from the U.S. to say anything was von Kármán, who offered comments about viscosity and shock wave

³⁰ K. Oswatitsch and K. Wieghardt, “Ludwig Prandtl and His Kaiser-Wilhelm-Institut,” *Annual Review of Fluid Mechanics* 1987, 19: 1-25, p. 11.

³¹ This brief summation said does not do justice to their presentations. Compressibility of fluids, drag rise with speed, even convergent-divergent nozzles were not new ideas, but as aircraft speeds rose, issues grew more complex and the tools to understand the problems were not all yet at hand. Theodore von Kármán prefacing a question after Busemann’s presentation, *Convegno di Scienze Fisiche, Matematiche Naturali: Le Alte Velocità in Aviazione*, p. 367. We know that some of these researchers were in communication with each other over technical questions starting in the early 1920s. Prandtl had been corresponding with Taylor and Dryden since 1923 and 1921 respectively, for example. Bodenschatz and Eckert, *Prandtl and the Göttingen School*, p. 20, <http://www.google.com/ur?sa=t&rct=j&q=&esrc=s&source=web&cd=6&ved=0CEIQFjAF&url=http%3A%2F%2Farxiv.org%2Fpdf%2F1107.4729&ei=4kedVaPhF4WXyGSOhKCwBg&usq=AFOjCNFIRAErSeQEUwhDxmHkEdJ52XUHg>, accessed July 8, 2015.

³² Busemann was slated to talk about high speed wind tunnels--“Aerodynamischer Auftrieb bei Überschallgeschwindigkeit” (Aerodynamic Acceleration at Super-Velocity): he clearly had something else on his mind. John D. Anderson, “Research in Supersonic Flight and the Breaking of the Sound Barrier,” in *From Engineering Science to Big Science: The NACA and NASA Collier Trophy Research Project Winners*, edited by Pamela E. Mack, (Washington, D.C.: NASA SP-4219, 1998), pp. 58-59; Ferrari, “Recalling the Vth Volta Congress: High Speeds in Aviation,” *Annual Review of Fluid Mechanics* 28, (1996) pp. 1-9; *Convegno di Scienze Fisiche, Matematiche Naturali: Le Alte Velocità in Aviazione*, pp. 2-3; Busemann’s talk was titled “Aerodynamischer Auftrieb bei Überschallgeschwindigkeit” (Aerodynamic Acceleration at Super-Velocity), *Convegno di Scienze Fisiche, Matematiche Naturali: Le Alte Velocità in Aviazione*, pp. 328-360. Busemann was 34 years old at the time of the Volta Congress; Jones was 35 when he presented his swept wing theory for publication. “Zwei Monate nach Ihrer Abfahrt will ich Ihnen einen Bericht über den Fortgang der Arbeiten bringen,” so begann Adolf Busemann, Prandtl’s engster Mitarbeiter jener Jahre, im November 1929 einen langen Brief an Prandtl.” Busemann correspondence to Prandtl, November 18, 1929 in Michael Eckert, *Ludwig Prandtl: Strömungsforscher und Wissenschaftsmanager, ein unverstellter Blick auf sein Leben*, (Berlin: Springer-Verlag, 2017), 184. AMPG, Abt. III, Rep. 61, Nr. 219. “Das Auftriebsproblem bei Überschallgeschwindigkeiten übernahm Busemann. In diesem Vortrag wurde zum ersten Mal aufgrund einer einfachen theoretischen Überlegung gezeigt, ‘dass sich die wirksamen Mächtschen Zahlen durch Schrägstellung der Tragflügel erniedrigen lassen,’ dass also im Überschallbereich gepfeilte Flügel vorteilhafter als gerade Flügel sein sollten,” Eckert, *Dawn of Fluid Dynamics*, p. 234.

³³ Busemann, “Aerodynamischer Auftrieb bei Überschallgeschwindigkeit,” *Convegno di Scienze Fisiche*, p. 342.

³⁴ Richard P. Hallion, “Gluhareff, Jones, and Lippisch: The Emergence of the Delta Planform and the Origins of the Swept Wing in the United States,” undated paper containing elements of an interview with R. T. Jones (1977?). “He {Busemann} was very young for a scientist and his idea of supersonic flight was considered impossible, even by leading researchers,” wrote Hans Ulrich-Meier, former department head at DLR’s research facility at Göttingen University. http://www.spacemart.com/reports/Swept_Wings_The_Breakthrough_To_Modern_Aviation_999.html, accessed July 17, 2017.

Prandtl and Busemann endured a common experience, although the former seems not to have realized it in 1935. In 1904 Prandtl presented “Flüssigkeitsbewegung Bei Sehr Kleiner Reibung” (Fluid Movement with Very Little Viscosity) at the Third International Mathematics Congress in Heidelberg, Germany. Prandtl introduced the boundary layer concept in his talk; the mathematicians were not impressed. We can forgive the Heidelberg audience since they were not fluid dynamicists, even if Prandtl kept his remarks to 10 minutes and used illustrations he thought would engage his listeners. Busemann’s audience, on the other hand, comprised leading professionals in aeronautics whom one might expect to recognize his paper’s significance. They did not. Robert E. O’Malley, “Ludwig Prandtl’s Boundary Layer Theory,” *Historical Developments in Singular Perturbations*, (Heidelberg, Gr: Springer, 2014), p. 1.

frequency. He chaired the session but found nothing memorable in it.) Even so, in his closing remarks Crocco acknowledged the gathering's impact: "after our meeting the literature on compressible fluids will rise vertically, just like the images Mr. Jacobs showed us."³⁵

Within a year Busemann's conceptual work would be cloaked in secrecy, part of the shuttering effect preceding the war, although research in Germany validated his theory in 1939 and work on swept wings continued there throughout the war.³⁶ But Jacobs had a copy of the proceedings, as did von Kármán. Present as a guest was Hugh L. Dryden, another American who had a copy of the proceedings. Four British researchers, a Swiss, and a French also had the proceedings—presenters from nations not hostile to the U.S. in the coming years—leaving us with a confounding question: how, ten years later, could the leadership at the NACA's Langley Memorial Aeronautical Laboratory reject Jones' work on swept wings as "hocus pocus [and] a snare and a delusion"? Consider:

The German aviation journal *Luftfahrtforschung* published a comprehensive version of Busemann's Volta Congress paper on the very day he read it in Rome. Subscriptions to the journal were not confined to Germany: Jones cited this article in his contentious Report 863.³⁷

The NACA's Paris Office translated a number of presentations from the Vth Volta Congress, which it forwarded for publication as Technical Memorandums (TMs) including: Ackeret's paper on high speed wind tunnels, C. F. Bona's report on Italian high-speed airplane engines, and Prandtl's talk on flow and compressible fluids. Ackeret's and Prandtl's papers were published in 1936.³⁸ (Jones referred to this Prandtl paper in TN 835 and 863.) Until 1958, the NACA's Office of Aeronautical Intelligence, a.k.a. the Paris Office, was the source of all the agency's TMs. Founded in June 1919, its job was to identify, acquire, and translate European (and on occasion Soviet) aeronautical reports deemed interesting or valuable, which were then

³⁵ Crocco, quoting von Kármán (author's translation): "Mr. De. Kármán me disait hier dans son langage expressive que la littérature des fluids compressible, après notre Réunion, va désormais, monte en paroi verticale comme les diagramme cinétique que M. Jacobs nous a montrés au tableau." *Convegno di Scienze Fisiche, Matematiche Naturali: Le Alte Velocità in Aviazione*, p. 655.

³⁶ Hans-Ulrich Meier, *German Development of the Swept Wing, 1935-1945*, slides accompanying a presentation at Hamburg, Germany, sponsored by the Royal Aeronautical Society, Deutsche Gesellschaft für Luft-und Raumfahrt, and Verein Deutscher Ingenieure; and Hans-Ulrich Meier, Burghard Ciesia, Hans Förshing, Hans Gleithner, Werner Heinzerling, Bernd Krag, and Helmut Schubert, *German Development of the Swept Wing, 1935-1945*, translated by Egon Stanewsky, (Reston, VA: AIAA, 2010). Hubert Ludwig, another aeronautical engineer at Göttingen, "carried out the first swept-wing measurements at AVA. Ludwig's measurements confirmed the correctness of Busemann's theory for the first time." http://www.dlr.de/100Jahre/en/desktopdefault.aspx/tabid-2565/4432_read-21499/, accessed March 21, 2017. Ludwig, Pfeilflügel bei hohen Geschwindigkeiten (Versuchs- ergebnisse). In: Bericht 127 der Lilienthal-Gesellschaft für Luftfahrtforschung über die Sitzung "Hochgeschwindigkeit" am Braunschweig, September 26-27, 1940, http://www.aviation.tu-darmstadt.de/media/arbeitskreis_luftverkehr/downloads_6/kolloquien/9kolloquium/heinzerlingflgelpfeilungundflch-enregel.pdf, accessed Aug. 14, 2018. Ludwig's wing tunnel examples had highly swept wings. Additionally, B. Göthert published Hochgeschwindigkeitmessungen an einem Pfeilflügel, Report 156, (Lilienthal Gesellschaft für Luftfahrtforschung, [1944?]) in which he explored wing sweep of 35 and 45 degrees. It was eventually published by the NACA as TM No. 1102: *High-Speed Measurements on a Sweptback Wing*, translated by Dean R. Chapman, (Washington, D.C.: 1947). Ernst Hirschel, Horst Prem, and Gero Madelung write that by 1943 swept wing aircraft were "on the drawing boards of all German aircraft manufacturers." Ernst Heinrich Hirschel, Horst Prem, and Gero Madelung, *Aeronautical Research in Germany: From Lilienthal Until Today*, (Heidelberg, Ger.: Springer-Verlag, 2004), p. 184.

There is the matter of the British supersonic effort that ended early in the war and from which the U.S. benefited. That effort itself drew in part from the 1935 conference, viz the angled wingtips courtesy of Ackeret.

³⁷ Busemann, A., "Aerodynamischer Auftrieb bei Überschall Geschwindigkeit," *Luftfahrtforschung*, Bd. 12, Nr. 6, October 3, 1935, pp. 210-220. Jones, "Report No. 863, Wing Plan Form for High-Speed Flight," endnote 9, p. 65.

As a younger man, Jones read the German classics in the discipline, viz. his reference to H[ans] Multhopp, *Zur Aerodynamik des Flugzuerumpfes*, *Luftfahrtforschung*, Bd. 18, Lfg, 2/3, 29 March 1941 in his *Notes on the Stability and Control of Tailless Airplanes*, NACA TN 837, (Langley Memorial Aeronautical Laboratory, NACA Langley Field, 1941), and William Sears, *Collected Works of Robert T. Jones*, p. viii.. For Langley's use of that journal, consider that in 1936 the NACA published J. Stüper, *Contribution to the Problem of Airfoils Spanning a Free Jet*, TM 796, *Luftfahrtforschung*, December 1935. Multhopp was one of Ludwig Prandtl's students and a prized aerodynamicist who eventually worked at the Glenn Martin Corporation, (which became Martin Marietta) on the SV-5/X-24A lifting body program. R. Dale Reed with Darlene Lister, *Wingless Flight: The Lifting Body Story*, (Washington, D.C.: NASA, 1997), pp. 129-130.

The conundrum continues: Jones' last reference in this critical paper was to von Kármán's "The Problem of Resistance in Compressible Fluids." The source is the Vth Volta Congress proceedings. "Th. von Kármán, The Problem of Resistance in Compressible Fluids, GALCIT Pub. No. 75, 1936. (From *R. Accad. D'Italia cl. di sci. fis., mate. nat.*, vol. XIV, 1936)" Jones, "Report No. 863, Wing Plan Form for High-Speed Flight," endnote 13, p. 65. Because we do not have his original draft to examine we cannot tell if Jones included these citations after the initial rejection, on the urging of other committee members, or to needle Theodorsen.

³⁸ J. Ackeret, *High-Speed Wind Tunnels*, translated by S. Reiss, NACA TM 808, (Washington: 1936). L. Prandtl, *General Considerations on the Flow of Compressible Fluids*, translated by S. Reiss, NACA TM 805, (Washington 1936), and C. F. Bona, *Italian High-Speed Airplane Engines*, translated by S. Reiss, NACA TM 944, (Washington, 1940).

forwarded to and published by the NACA in the U.S. (without author consent).³⁹ It is unknown how a copy of the proceedings found its way to the Paris Office, what with the limited number in existence. (The AFRC research library borrowed *Convegno di Scienze Fisiche, Matematiche Naturali: Le Alte Velocità in Aviazione* from the NASA Jet Propulsion Laboratory, of which von Kármán was once director; the document carries a 1935 accession stamp.) Given the NACA's perspective at the time, framed by such ideas as a 550-miles-per-hour (885 km/hr) ultimate speed of aircraft, someone or some committee reviewed the collection of papers from the Vth Volta Congress and chose not to translate Busemann's paper.

To top it all off, Jones recalled that leading up to the initial peer review meeting about his report committee member Robert Hess came across Busemann's 1935 paper in the Langley collection and brought it to the attention of the committee.⁴⁰ (Jones did not say which version of Busemann's paper Hess discovered.) It was not enough to forestall Theodorsen's epithets.⁴¹ Jones' work was *sui generis*, having reached his own, independent conclusions on the subject in part by linking his ideas to a four-page report published in 1924 by his mentor, another NACA engineer (German émigré and Prandtl protégé), Max Munk, who wrote: "In straight flight, only the component of velocity $V \cos \delta$ is effective for the creation of lift."⁴²

³⁹ J. Ackeret, *High-Speed Wind Tunnels*, translated by S. Reiss, NACA TM 808, (Washington: 1936). L. Prandtl, General Considerations on the Flow of Compressible Fluids, translated by S. Reiss, NACA TM 805, (Washington 1936), and C. F. Bona, *Italian High-Speed Airplane Engines*, translated by S. Reiss, NACA TM 944, (Washington, 1940). Access to the TMs was restricted. Unlike TNs and RMs, TMs had no tear-out cards in the back for readers to mail in and request an additional copy, suggesting that they were distributed to Agency libraries or to other government and industry partners. Karl Bender, conversation with Christian Gelzer, December 8, 2016.

⁴⁰ Robert T. Jones, "My Adventures in Aeronautics," an undated and unpublished autobiography, Department of Special Collections, Stanford University Libraries, box 11, folder 11, in Bruce I. Larimer, *Thinking Obliquely: Robert T. Jones, the Oblique Wing, NASA's AD-1 Demonstrator, and its Legacy*, (Washington, D.C: NASA, 2011), p. 15. While Langley finally accepted Jones' paper for publication in June 1945, it was not forwarded to Congress and the president for publication (the requisite process at the time) until 1947, and it was not actually published until 1950.

Following the occupation of Göttingen in April 1945, Prandtl and his colleagues went to the Institute only to show arriving American and British around and answer questions. Albert Betz recalled: "The questions asked during these guided tours often gave us an insight into matters of fact that were surprises to us. Most of the Americans could not understand that we were mostly doing fundamental research. Even the big difficulties with manpower and material during the war were often unimaginable for them. The question came up again and again, why we built swept wings, and it required long and repeated explanations until the advantages of this type of wing on approaching sonic velocity were understood. Now swept wings are foisted as a big American invention." Vogel Prandtl, *A Biographical Sketch, Remembrances and Documents*, p. 157.

Trying to defend its failures after the war, "the staff at Langley actually drew up an 'Appraisal of German Research during the War Compared to that of the NACA' and found themselves relatively blameless." Even some in the NACA found this hard to swallow. Roland, *Model Research*, pp. 204-205.

⁴¹ While providing some accounting for institutional problems that surfaced in the years preceding WWII, Roland's explanation, like Hansen's and Anderson's, does not get to the nub: why engineers and researchers at the NACA so familiar with pure research and conceptual work, as well as research driven by the need for immediate solutions to problems, could fail to appreciate the significance of a professional colleague's conceptual aeronautical work, in this case, Busemann's insight regarding swept wings and high speed flight. According to the interviews and accounts Hansen collected and the material available to him, neither Jacobs nor von Kármán, both of whom presented at the Volta Congress, and not Dryden, who also attended, remembered the "arrow-wing" concept "as anything important." Hansen, *Engineer in Charge*, p. 283. Following an interview with Busemann while his team were scouring overrun German military sites, cities, and universities, von Kármán wrote about the *Pfeilflügel* concept that Busemann presented in 1935, but the information went into a classified report that was apparently not available to the NACA. Nearly two decades later von Kármán wrote of watching Gen. Crocco render a version of Busemann's swept wing airplane on a menu, but this account did not surface until the 1960s, long after swept wings were common. In later years von Kármán conceded of Busemann's talk: "I have to admit that I, at the time, did not pay much attention to his suggestion." Theodore von Kármán, *Where We Stand, First Report to General of the Army H. H. Arnold on Long Range Research Problems of the AIR FORCES with a Review of German Plans and Developments*, (Scientific Advisory Group: Army Air Forces, August 22, 1945), Kármán, *Aerodynamics*, (New York: McGraw-Hill Book Company, Inc., 1963), p. 133, and Kármán, *Die Wirbelstrasse, mein Leben für die Luftart*, (Hoffman und Kampe Verlag, 1968), p. 263, cited in Hans-Ulrich Meier, et al., *German Development of the Swept Wing, 1935-1945*, p. 30. "Although Busemann's lecture was widely accessible and its revolutionary, practical significance was discussed, Kármán only took the arrow-wing concept outside Germany after the Second World War. In retrospect Kármán wondered that this was the "most important lecture at the conference." Karman and Edson, *The Wind and Beyond: Theodore von Karman*, p. 234. Among other things, this underscored the rift between the Army Air Forces and the NACA, something that was evident institutionally and in leadership. That this happened, and that the proceedings (and perhaps the memories) of the 1935 Volta Congress could all but disappear bespeaks the intellectual chasm Jones encountered when presenting his own swept wing concept to his peers.

⁴² Max Munk, *Note on the Relative Effect of the Dihedral and the Sweep Back of Airplane Wings*, NACA TN No. 177, (Washington, D.C.: National Advisory Committee for Aeronautics, 1924), p. 3. Nomenclature was not yet set in the field of aeronautics. William Sears appropriately referred to Jones as one of Prandtl's intellectual "grandchildren." Jones received the Sylvanus Albert Reed Award

Despite all this, it remains that the NACA's methodical research pace acquired long before WWII proved a key factor in the evolution of the Agency's measured approach to flight research, to safety, and to a degree, its redemption. But it had to find its "knowledge production" again, as historian Robert Ferguson put it - something it set aside in favor of product refinement for the military during the war, what Hugh Dryden termed "quick fixes."⁴³ The evidence suggests that it had lost more than just a step or two in that field by 1945, and there was much ground to make up; yet this it did.

The ground it made up in a decade and a half is remarkable. Moving from a rejection of the rationale for swept wings, the NACA quickly came to terms with supersonic flight, and embraced research into swept wing, high-speed aircraft, high altitude and multi-Mach flight, and spaceflight. In addition to being reformed with a new focus, the Agency regained an inquisitiveness that led to an exploration of wingless entry vehicles for flight from space to a landing, exo-atmospheric control systems, fly-by-wire technology, viable thermal protection systems for reusable spacecraft, and more. In this context, the direct result was the first commercial reusable spacecraft, the space shuttle orbiter. What follows is an examination of how the Agency recovered, the AFRC's centrality to that process, and its contributions to both the fundamental changes at the Agency and the advent of the space shuttle itself.

from the Institute of Aeronautical Sciences in 1946 for his swept wing work, the same year he left Langley for Ames.

⁴³ Robert G. Ferguson, *NASA's First A: Aeronautics from 1958-2008*, (Washington, D.C.: NASA, 2013), p. 52; Hugh L. Dryden, "NACA: What it's Doing and Where it's Going," *Missiles and Rockets I* (October 1956), p. 45.

2: Supersonic Flight

Curtis Peebles

Jacobs Technology

NASA Armstrong Flight Research Center

Abstract:

To tackle supersonic flight the NACA developed a new pattern for research to better match the new jet and rocket powered aircraft and the regime of high speed, high altitude flight in which they operated. The patterns the NACA developed were not immediately copied by its chief partner, the Air Force - with severe consequences.

Keywords:

International Geophysical Year (IGY); Society of Experimental Test Pilots (SETP); Neil A. Armstrong; Transonic wind tunnel; X-1; X-2

The lead story for both *Time* and *Newsweek* on Friday, October 4, 1957 was the deployment of the 101st Airborne Division to Little Rock, AR to enforce a federal court order to integrate Little Rock Central High School. With the growing turmoil over civil rights throughout the South, a conference on the International Geophysical Year (IGY) in Washington, D.C. attracted little attention.⁴⁴

When the conference wrapped up that Friday evening the delegates attended a reception at the Soviet embassy. A few minutes before 7:00 p.m., Walter Sullivan, science reporter for *The New York Times*, was called to a telephone: on the other end was his editor, who told him that TASS (Telegraph Agency of the Soviet Union) had just issued a bulletin. Sullivan had been expecting it, and, after hanging up the telephone, walked over to Dr. Richard Porter, a member of the committee overseeing the U.S. Vanguard satellite project. Quietly, Sullivan said to Porter, "It's up." The two then found Dr. Lloyd Berkner, a member of President Eisenhower's Science Advisory Committee and head of the U.S. IGY program and told him. Berkner tapped on the hors d'oeuvres table for silence.

I wish to make an announcement. I have been informed by The New York Times that a Russian [sic] satellite is in orbit at an elevation of 900 kilometers. I wish to congratulate our Soviet colleagues on their achievement.⁴⁵

That same night members of the Society of Experimental Test Pilots (SETP) gathered at the Beverly Hilton, in Los Angeles, CA for the group's first annual awards banquet. Some 650 attended, including such well-known test and research pilots as Joseph A. "Joe" Walker, A. Scott Crossfield, William B. "Bill" Bridgeman, Anthony "Tony" LeVier, Lt. Gen. James "Jimmy" Doolittle, and Maj. Gen. Albert Boyd.⁴⁶ Much as Sputnik affected the IGY reception, news of the satellite's launch rippled through the gathering at the Beverly Hilton. Among the younger group of pilots at the banquet was one who had already flown several project aircraft at the NACA High-Speed Flight Station, including the B-29 launch aircraft (a P2B-1S), the B-47, F-100, F-51, and R4D (Navy version of the DC-3). He'd made his first rocket plane flight in the X-1B barely two months earlier, on August 15, 1957: better than anyone else at the gathering, Neil A. Armstrong symbolized how much would change with the launch of Sputnik.⁴⁷

⁴⁴ Conceived by the National Academy of Sciences in 1952 as a "comprehensive series of global geophysical activities to span the period July 1957-December 1958," the IGY eventually had the participation of 67 countries. Of all the tools then available, the rocket, a post-WWII reality, presented the greatest breakthrough and much of the research relied on rocket launches and flights. <http://www.nas.edu/history/igy/>, accessed December 2, 2014.

⁴⁵ Richard Witkin, *The Challenge of the Sputniks*, (New York: Doubleday Headlines Publications, 1958), p. 4, and Robert A. Divine, *The Sputnik Challenge: Eisenhower's Response to The Soviet Satellite*, (New York: Oxford University Press, 1993), p. xiii. Berkner was the first to propose the IGY, in 1952.

⁴⁶ Walker flew for the National Advisory Committee for Aeronautics (NACA) and would later be the first civilian X-15 research pilot; Crossfield, the first person to exceed Mach 2, also flew for the NACA; Bridgeman worked for Douglas Aircraft Company as a test pilot, having flown the D-558-II, among other things; as a Lockheed Aircraft Corporation test pilot LeVier was the first to fly the P-80; Doolittle was most famous for leading the B-29 raid on Tokyo during WWII; and Boyd, himself a test pilot, commanded the Muroc Army Airfield (later Edwards) when Yeager first flew past Mach 1. Annual, (Society of Experimental Test Pilots, n. a., 1957), pp. 39-41. SETP's *Annual* mentions reporters who were expected at the gala that night but who were absent because of Sputnik.

⁴⁷ The flight in the X-1B had been an early flight test of a reaction control system. Absent that night was another member of the SETP community, John Glenn Jr., who was appearing on an episode of the television show *Name That Tune*. <http://www.dailymotion.com/>

It had been ten years almost to the day since the first supersonic flight, and this night marked another great divide: between what came before Sputnik and what came after.⁴⁸ Armstrong had been part of the transformation the NACA brought about with the X-planes, and he would be part of what it led to. That transformation not only remade the Agency, it set the Agency up for its next role—space—and it left the reformulated Agency (NASA) at once properly suited for the task handed to it, and the only entity suited for that task. Indeed, the NACA/NASA was prepared precisely *because* of what it went through in the previous decade, and in large measure because of the work done by the Agency’s research facility at Edwards Air Force Base.

Beginnings

Eleven years before Sputnik’s launch thirteen people departed the NACA’s Langley Memorial Aeronautical Laboratory in stages for the spartan Muroc Army Airfield and its undeveloped surroundings in the High Desert of California. They travelled west in late 1946 to support the X-1 and the quest for supersonic flight. Aircraft with an “X” prefix predated the X-1, but the nature of such aircraft was very different from those that carried a stand-alone “X” designation. North American Aviation’s (NAA) XP-86, for example, denoted an experimental version of a fighter built under contract for the Air Force. The XP 86 was followed by a YF-86—“Y” for “service test”—which the Air Force would use to evaluate the design; if accepted (it was), the prefix would become simply “P”. (Following its establishment as an independent entity in 1947, the Air Force changed aircraft designations in its inventory. In the process “pursuit” became “fighter” and active aircraft were given new prefixes, including the NACA’s P-51, which was re-designated an F-51. The XP-86 would eventually become the F-86. “Y” became “prototype” in 1962.⁴⁹) Implicit in the designations was a production run: whether or not the run followed depended on several factors, among them the aircraft’s suitability, its performance, and shifting requirements.

None of this applied to the X-1 or subsequent X-planes, which were designed and built to answer specific questions about aerodynamics, structure, power, control, thermostructural characteristics, and human physiology, and to explore specific regions of flight. These were not pre-production fighters or bombers, but flying experiments, and they were singular - typically only one or two of each were built.⁵⁰ The X-1 (technically the XS-1 for eXperimental Supersonic-1 but soon referred to merely as the X-1) brought the NACA to the small desert outpost in late 1946: it was, Anthony Rotundo wrote “the first airplane constructed solely for high-speed research.”⁵¹ Just as importantly, he added, this project created a pattern for subsequent X-plane development involving the NACA, branches of the military, and aircraft manufacturers. The NACA’s initial, and then continued presence at the desert outpost was a direct result of this effort.

But why come west to Muroc Air Field for this work—why not conduct this research in the high-speed wind tunnel at Langley? In the 1970 von Kármán Lecture, Courtland Perkins told his audience: “The fear of aerodynamic unknowns that might be encountered in flight beyond the so called ‘sound barrier’ and the inability, at that time, to test adequately in wind tunnels led to the research airplane program introduced near the end of World War II.”⁵² The crux was in the limits of the existing wind tunnels. As long as engineers were trying to acquire subsonic data, specifically data below the transonic realm, existing wind tunnels were good

video/x54r7ka, accessed May 16, 2018.

⁴⁸ Lloyd Berkner dubbed this demarcation “A.S.,” or “after sputnik,” [sic] in 1959. Lloyd V. Berkner, Address to the American Geophysical Society, January 20, 1959, in *The Next Ten Years in Space: 1959-1969*, Staff Report of the Select Committee on Astronautics and Space Exploration, 86th Congress, First Session, House Document No. 115, (Washington, D.C.: U.S. Government Printing Office, 1959), p. 21.

⁴⁹ Dennis Jenkins, email to Christian Gelzer, August 13, 2018. “Any aircraft, which is not in normal operational service, can receive a prefix letter in its designation to reflect its current status.” <http://www.designation-systems.net/usmilav/aircraft.html>, accessed September 22, 2018.

⁵⁰ One could take exception to this with the Convair XP-92 (eventually the XF-92) – which was intended to become the P-92 (F-92) but was cancelled. The company drew much from the delta wing XP-92 to develop the F-102 and F-106.

⁵¹ Rotundo, *Into the Unknown*, p. 3.

⁵² Courtland D. Perkins, “Development of Airplane Stability and Control Technology,” 1970 Von Kármán Lecture, *Journal of Aircraft*, Vol. 7, No. 4, p. 291: 69-1137, AIAA 6th Annual Meeting and Technical Display, Anaheim, Calif., October 20-24, 1969. Perkins worked in the Air Corps’ Stability and Control Unit at Wright Field starting in 1941, making him a contemporary of Paul F. Bickle, the first Director of today’s Armstrong Flight Research Center. Perkins taught at Princeton University and later served as Chief Scientist of the U.S. Air Force.

tools. But when attempting transonic research, they found that wind tunnels yielded erratic data at best.⁵³

At subsonic speeds the throat of a wind tunnel restricts the flow, accelerating the moving volume of air. On exiting the throat, the air decelerates to its original speed, all of which follows the law of conservation of mass and Bernoulli's principle.

At close to Mach 1 "the laws of physics start to change for airflow in tunnels...shifting from incompressible to compressible."⁵⁴ When passing through an empty throat, supersonic airflow *decelerates* (to Mach); on exiting the throat it *accelerates*. Moving supersonic air through a wind tunnel was not itself a problem; several supersonic tunnels existed prior to WWII, all in Europe.⁵⁵ But when researchers placed a model in the test section it "choked" the throat, preventing the freestream airflow ahead of the model from even reaching Mach. Worse, shockwaves developed in the transonic realm which bounced off the tunnel walls and back onto the test model, thoroughly muddling data. Increasing airflow velocity in the contraction section on the assumption that this would force air in the throat to go supersonic was pointless: if the throat choked, the flow would never go supersonic. Researchers could place test models in the diffuser section of the tunnel and get data above the transonic realm but this still left a void in aeronautical knowledge for the critical transonic realm.⁵⁶ John Anderson nicely illustrated what was then sometimes called the "blind spot" in his *A History of Aerodynamics*.⁵⁷

Recognizing these problems in the 1940s, researchers at Langley tried other methods to acquire transonic data. The most successful of these used "the local region of transonic and supersonic flow that develops on wings at high subsonic speeds as a medium" to test small aerodynamic models. They attached small wing sections to the top of a P-51 wing and then flew the aircraft in a dive to develop transonic and even supersonic flow over the wing, making it a "flying wind tunnel."⁵⁸ The eventual solution to numerous problems that prevented transonic wind tunnel data acquisition seems to have come at the hands of Ray H. Wright, of Langley, in 1946, whose work led to a tunnel with longitudinal slots placed strategically in the walls of the throat. These slots managed to keep the shockwaves from rebounding or the throat from choking, allowing unadulterated data collection at transonic and supersonic speeds.⁵⁹ "By changing throats the eight foot [2.44 m tunnel] could go supersonic but nobody had gone transonic. That was only possible with the slotted throat."⁶⁰ But this discovery came too late to help the X-1 project, which was already flying.

Those from the NACA who came west for the X-1 did not intend to stay. They came to see the project through Mach 1, to collect and analyze the data from all of the flights in order to understand what was happening to an aircraft under the circumstances, and then return to Virginia. But as the X-1 data mounted, they realized that they knew almost nothing about this new realm of flight except that there seemed to be an infinite number of questions to ask and try to answer. Ahead lay things not only begging exploration—in many cases they had to be explored: the Cold War was under way and their partners in the military

⁵³ Steven T. Corneliussen, "The Transonic Wind Tunnel and the NACA Technical Culture," in *From Engineering Science to Big Science: The NACA and NASA Collier Trophy Research Project Winners*, edited by Pamela E. Mack, (Washington, D.C.: NASA SP-4219, 1998), p. 128.

⁵⁴ Perry Roth-Johnson email to Christian Gelzer, November 22, 2016, and Christian Gelzer's conversations with Albion Bowers, November 16, 2016, and Perry Roth-Johnson, November 22, 2016. Putting a model in a transonic/supersonic wind tunnel in this period effectively narrowed the throat's diameter, leading to the choking.

⁵⁵ Jakob Ackeret designed the first supersonic wind tunnel and led the development of others around Europe, including one the Vth Volta Congress attendees visited in 1935 just outside Rome, John D. Anderson, Jr., *A History of Aerodynamics*, (Cambridge, UK: Cambridge University Press, 1997, paperback ed. 1998), p. 419.

⁵⁶ Corneliussen, "The Transonic Wind Tunnel and the NACA Technical Culture," pp. 91-133; Christian Gelzer, conversations with Albion Bowers, November 16, 2016, and with Perry Roth-Johnson, November 22, 2016. The transonic realm is customarily defined as .8 Mach to 1.2 Mach.

⁵⁷ Anderson, *A History of Aerodynamics*, 1998, p. 406. See also Robert Hotz, "New Tunnel Throat Aids Transonic Study," *Aviation Week* 25, Vol. 50 (June 20, 1949), pp. 12-13.

⁵⁸ Becker, *The High-Speed Frontier*, p. 84. The first trials came in 1940 using a Brewster XF2A-2 and in 1944 Robert Gilruth suggested trying it again. Langley engineers accustomed to wind tunnel work resisted the idea. Gilruth persisted, saying that any transonic data were better than none at all. "There was great consternation amongst the wind-tunnel people in why a young upstart [Gilruth] could come along [with a solution] when all their wind tunnels had" failed. Hansen, *Engineer in Charge*, pp. 264-265.

⁵⁹ As with most innovations, there were conceptual antecedents to this as well as moderate testing, but no complete, closed wind tunnel. Corneliussen, "The Transonic Wind Tunnel and the NACA Technical Culture," pp. 130-131. Now usually referred to as the slotted wall wind tunnel, it was initially known as "ventilated-throat transonic tunnel." Walter C. Williams and Hubert M. Drake, "The Research Airplane: Past, Present, and Future," *Aeronautical Engineering Review*, January 1958, p. 37.

⁶⁰ Helen H. Willey, interviewed by James R. Hansen, "When Computers Were Human," [n.d.], <https://www.youtube.com/watch?v=Dh-EHz3RtM8>, accessed January 19, 2017.



An NACA technician standing in front of the instrumentation the Bell X-1 carried on research flights. NASA E-4837

and industry had questions as well. As a result, instead of going home, many who came west remained to investigate these new questions in concert with their partners. A series of X-planes ensued, built by different companies (neither the NACA nor the Air Force were allowed to build their own aircraft) - initially single point designs flown first by the Air Force for “rapid exploration of the airplane over its performance envelope” (or the Navy in two instances) and then transferred to the NACA for a “more detailed and systematic study.”⁶¹ Outright speed and altitude were among the first objectives, at least for the military (the NACA initially planned as many as 100 flights with the X-1 to collect data, yet even then it would not reach Mach 1; the Air Force reached Mach 1 on the ninth powered flight). And so, the X-1 (and variants) was followed by the Bell X 2, a rocket plane expected to exceed Mach 3. The Douglas D-558-I and D-558-II (funded by the Navy) were X-planes in all but name, that designating prerogative belonging to the Air Force. The D-558-II was the first swept wing rocket plane to explore supersonic flight in the U.S. The Northrop X-4 explored flight in an aircraft without horizontal stabilizers while the Bell X-5 was the first to test wings whose geometry could be varied in flight; the Convair XF-92 explored the aerodynamics of a delta wing, and the North American Aviation X-15 examined hypersonic flight and aero-thermal-structural questions.

The NASA High-Speed Flight Station separated from Langley and became an independent Center in 1959. It was not a forgone conclusion that the research projects in which it was involved would lead to spaceflight, but there had been an assumption for some time prior to 1959 that the aeronautical research begun at the desert location was merely the first of three formally identified developmental rounds.⁶² Round One used

⁶¹ Jacob Neufeld, George M. Watson, Jr., and David Chenoweth, eds., *Technology and the Air Force: A Retrospective*, (Washington, D.C.: U.S. Air Force, 1997), p. 59.

⁶² The three-round plan should be understood in context of the immediate post-war period: at the time of the plan’s conception the X-1 existed but had not completed many powered flights; the D-558-1 existed, itself just a transonic research aircraft, the X-2 was merely an idea and not the Mach 3 airplane it briefly became; the D-558-II was then still under construction, and the X-3 was still a concept. The D-558-II was the first aircraft to exceed Mach 2, but that did not happen until late 1953 and then only as a pure rocket plane; as designed and delivered the D 558 II was a hybrid jet / rocket plane that took off from the lakebed on its own power, and as such was barely able to reach Mach 1. Round Two was the X-15, the design of which did not begin until 1953. Round Three was the X-20 - a

various aircraft to reach Mach 3 and 100,000 feet (30.5 km). Round Two was the X-15 - hypersonic flight, even to and from space. Round Three was the X-20 Dyna Soar (Dynamic Soaring), a space plane launched from atop a Titan III rocket and flown back to Earth. Inherent in the three Rounds of exploration was a step-by-step ascension in speed and altitude, culminating with spaceflight.⁶³ Describing the Rounds this way, however, can obscure the broader nature of the process. The three Rounds were not after benchmarks so much as cumulative data. “The records are incidental to the main effort of exploring new flight regimes,” wrote James Martin of the NASA Flight Research Center.⁶⁴ Knowledge production once again had primacy.

spaceplane about which there was then very little real knowledge.

⁶³ High-speed and altitude records associated with this research over the decades is frequently presented as the objective—not overtly, but by omitting or passing over essential details about the programs and projects. There are differences between Mach 2 and Mach 4 in terms of the effects on materials or propulsion systems, for example, but such arbitrary benchmarks suggest a ladder-like ascent. Excepting certain salients, it is best to think collectively of the research as an expanding body of knowledge filled predominantly with linear gains in understanding.

⁶⁴ James A. Martin, “The Record-Setting Research Airplanes,” *Aerospace Engineering* 21 (12): Dec. 1962, pp. 49-54.

3: Turning into the Wind

Christian Gelzer and Curtis Peebles
Logical Innovations, Inc., and Jacobs Technology
NASA Armstrong Flight Research Center

Abstract:

The NACA's new methods developed at the remote site at Edwards improved safety while setting rules for space-bound vehicles. In 1958 NASA emerged from the NACA with a focus on space. This new Agency drew heavily on the desert facility's experience with rocket planes, energy management, aero-thermo-structural loads, reusable spaceplanes, and micro gravity.

Keywords:

Chuck Yeager; Mel Apt; Scott Crossfield; Bill Dana; X-15; NASA; control room; Space

Air Force (AF) Capt. Charles "Chuck" Yeager exceeded Mach 1 in the straight-wing Bell X 1 on October 14, 1947 on the aircraft's ninth powered flight. He did so again on January 22 and January 30, 1948 (the next AF pilot to go supersonic was John Fitzgerald, on April 6, 1948), flights the NACA staff at Muroc was well aware of since its engineers instrumented the aircraft and their computers reduced the raw data. Not until March 4, 1948—nearly six months after Yeager's first supersonic flight—did an NACA pilot exceed the speed of sound.⁶⁵ The lag underscored the NACA's focus on data over benchmarks.

The era that followed reshaped the NACA, and particularly the group of employees at Muroc, but this was not inevitable: it reflected a shift in the organization's awareness of circumstances, needs, and possibilities, and to a degree the de facto independence with which the small group at the outpost operated. As a consequence, the nature of the research conducted at the desert location in the Antelope Valley of California, and the demands of the new regimes of speed and altitude, had a profound effect on those who worked at the Flight Research Center and how they did things. Because of the growing complexity of X-planes that followed the X-1 (and that were contemporaries in many cases), both technically and in the demands they imposed on their pilots and ground crews, the Flight Research Center developed a more formal set of procedures that covered all aspects of checkout, flight planning, and safety. This development was really just an extension of its methodical approach to research.⁶⁶

The new pattern that emerged began on delivery of a research aircraft. Aircraft components were tested individually before being installed (or reinstalled) in the aircraft; then the subsystems underwent individual tests to establish that they operated as designed, followed by tests of the individual systems, which ensured

⁶⁵ Herbert H. Hoover was the third pilot to go supersonic. Oddly, there seems little unanimity on the details of the first ten X-1 supersonic flights.

It's worth remembering that Ernst Mach believed there was a biological consequence to supersonic flight and it wasn't good. He was not alone. Some believed that supersonic flight would push one's voice behind or down into one's throat. Even the NACA's headquarters staff were skeptical when the Muroc Unit reported successful supersonic flight on October 14, 1947. In a letter dated October 22, 1947 the NACA Headquarters (HQ) requested a validation of the original calculations (and included references the engineers might avail themselves of to do the job reliably...). As late as 1949 the NACA HQ chief engineer still felt the "the data was somewhat too preliminary to publish." Ernst Mach, *Space and Geometry: In Light of Physiological, Psychological and Physical Inquiry*, translated by Thomas J. McCormack, (Chicago, IL: The Open Court Publishing Company, 1906) originally published between 1901 and 1903 as three articles in *The Monist*; Memo from Langley Memorial Aeronautical to Chief of Research, (W. Williams) NACA Muroc Flight Test Unit, October 22, 1947, AFRC Historical Reference Collection; and Robert Kempel exit interview, NASA Dryden Flight Research Center Video Office. Other popular suggestions included the idea that if one flew faster than the Earth turned (Mach 1.4) and did so in a contra-rotating direction, one could land before having taken off. Fears about the impact of speed on the human body date to the early 19th century and the advent of steam propulsion in trains, the first conveyance to exceed the horse. In 1830 the Lancaster, Ohio, school board observed that if God had meant "his creatures" to travel at the "frightful speed of 15 miles per hour He would have foretold it through His holy prophets." Such speed (the railroad) was the "device of Satan to lead immortal souls to hell." Similar concerns were expressed in England, where the steam locomotive was invented. The quotation can be found in the Pennsylvania Railroad Museum, Strasburg, Pa., and appears to have been issued after a request to use the school as a place to debate the practicality of the railroad. Christian Gelzer, "The Quest for Speed: An American Virtue, 1825-1930," PhD diss., Auburn University, 1998.

⁶⁶ For a comprehensive examination of the X-Plane series and the NACA's involvement, see Curtis Peebles, with contributions by Richard P. Hallion, *Probing the Sky: Selected NACA Research Airplanes and Their Contributions to Flight*, (Washington, D.C.: NASA, 2014). https://www.nasa.gov/connect/ebooks/aeronautics_ebooks_archive_1.html, accessed May 30, 2018.

that they, too, operated correctly. Next came integrated system checks to confirm that the different systems functioned properly in unison without causing interference or a failure. It was a long, complex process of ground checks, but one which helped to prevent errors from slipping through. The final step was the pre-flight checkouts to ensure all systems were operational.⁶⁷

Once the aircraft checks were complete, planning began for the research flights, which itself evolved into a multi-step process. Weekly meetings drew together all the personnel assigned to the project for a review of the project's status: they discussed technical issues from the previous flights (if any) and pre-flight ground checks. Project leaders assigned engineers to find solutions to outstanding issues, including any work-arounds, modifications, or replacement of components. The solutions were then tested to ensure they performed as needed. If the problem was solved, the issue was closed; if the problem persisted, the issue remained open and the analysis and testing continued. Configuration control emerged as a critical element in the process, (neither the term nor the practice were the NACA's creation), because each modification made to a research aircraft had to be documented and the actual configuration of the aircraft had to match that depicted in the configuration control documents. This process allowed the engineers to go back and reconstruct the sequence of changes to understand how a problem was fixed, why it was not corrected, or perhaps why a new problem appeared. In the event a failure resulted in the loss of an aircraft, the chain of events leading to the failure might be reconstructed.⁶⁸

At the end of this process the final reviews took place. The engineering review board and the configuration control board meetings happened in the final weeks before a flight. Just ahead lay the final step, the Technical Briefing - a formal review of the project's status and plans for flight with Center leadership present. Each of the lead engineers made formal presentations about their area of responsibility, after which they were questioned in detail. A part of this last procedure was a review of the flight plan itself, including the test points to be performed along the way, and emergency procedures. Only then was it time to fly.⁶⁹

Today these processes are a matter of course, but they were the hard-earned lessons of the early X-planes era - steps put in place as experience grew with high-performance, often rocket powered, aircraft. Initially, for the AAF planning an experimental flight at the base could be a casual affair.

Air Force historian James O. Young recalled that in anticipation of X-1 flights Hartley Soulé recommended that AAF personnel read several NACA flight-data reports, the results of wind tunnel testing, and other testing results. He also provided AAF personnel with a copy of the NACA flight plan and asked for a copy of theirs in return. The [AAF] Flight Test Division representatives told them no flight plan had been developed listing specific Mach numbers and altitudes. Decisions on such matters would not be made until the flights were under way and would be based on data analysis and Yeager's recommendations after each flight. Indeed, it must have appeared to them [NACA] that the AMC [Air Material Command] had no real plans at all. Colonel Boyd summed up the Flight Test Division's approach stating that common sense, sound engineering experience, and a focus on safety would be the guideposts for its efforts.⁷⁰

Yeager's own memory of preparations for the X-1 flights is equally revealing: "I'd attended these highly technical NACA pre-flight planning sessions... and not known what the hell they were talking about."⁷¹

Things weren't materially different as late as 1953 and the events surrounding the effort to best the NACA's Scott Crossfield's Mach 2.005 record, which he set in a Douglas D 558-II in November of that year. Yeager and Capt. Jack Ridley, close colleagues since the first supersonic flight in the X-1, began planning this particular flight even before the X-1A had flown supersonically. This was a second-generation X-1 - slightly longer, carrying more propellants, and capable of higher speeds. The goal was to reach Mach 2.2 or Mach 2.3 on the airplane's fourth powered flight. The biggest obstacle, the two believed, was a reduction of the X-1A's

⁶⁷ Milton O. Thompson and Curtis Peebles, *Flying Without Wings: NASA Lifting Bodies and the Birth of the Space Shuttle*, (Washington, D.C.: Smithsonian Institution Press, 1999), pp. 102-103; and John McTigue, interview with Curtis Peebles, September 22, 2010.

⁶⁸ Curtis Peebles, "Then and Now: Flight Research in the Second Half of the 20th Century," *SAFE Journal*, Vol. 34, No. 1 Fall 2006, pp. 37-38; and Peebles, "Risk Management in the X-Planes Era: D-558-II vs. X-1A at Mach 2," *Quest*, Vol. No. 11, No. 4 2004, pp. 40-47.

⁶⁹ Curtis Peebles, *Road to Mach 10: Lessons Learned from the X-43A Flight Research Program*, (Reston Virginia: American Institute of Aeronautics and Astronautics, 2008), 190-192; and Betty Love, interviewed by Curtis Peebles December 23, 2003, in his personal collection.

⁷⁰ James O. Young, *Meeting the Challenge of Supersonic Flight*, (Edwards Air Force Base, CA: Air Force Flight Test Center History Office, 1997), pp. 45-47.

⁷¹ General Chuck Yeager and Leo Janos, *Yeager: An Autobiography*, (New York: Bantam Books, 1985), p. 108.

stability at Mach 2.3, but they didn't expect to exceed that Mach number, so Yeager and Ridley pressed on with their flight plan: both thought the reduced stability at high speeds could be dealt simply with proper piloting technique.⁷²

Yeager and Ridley were also the ones who assessed the flight risks. A chain of command existed, but Yeager recalled: "Jack [Ridley] and I were on our own, pretty well free to do our own planning and flight profiles with neither [the] NACA nor the Air Force looking over our shoulders." There was no review, no independent assessment, and no one to determine what would trigger a flight termination.⁷³ Fred Stoliker, an Air Force flight test engineer in the period, recalled: "the [Air Force] FTE and pilot had a great deal of flexibility in selecting tests to be conducted. The operations and engineering supervisors were seldom involved ... this same flexibility existed in flight."⁷⁴

The attempt came on December 12, 1953 and Yeager reached Mach 2.44 before he lost control of the X-1A. The aircraft tumbled while losing some 50,000 feet (15.24 km). The violence threw Yeager about so hard that his helmet cracked the Plexiglas® canopy, knocking him unconscious; he revived in time to find the aircraft in an inverted spin, from which he recovered into an upright flat spin and then into a glide. Despite the pounding he'd endured and without a chase plane for guidance (it was a Saturday) Yeager was able to land on Rogers Dry Lake at Edwards. He'd expected some instability but nothing like this and after recovering control but before landing he radioed: "You know, if I'd had a[n ejection] seat, you wouldn't still see me in this thing."⁷⁵ The cause of the wild and violent gyrations around all three axes leading to the loss of control was inertia coupling, with which he was entirely unfamiliar (but which the NACA could deduce evidence of because the aircraft carried an NACA data acquisition system).⁷⁶

The contrast between the NACA's D-558-II Mach 2 flight planning and Yeager and Ridley's X-1A Mach 2.44 flight is marked. Although the NACA engineers may not have articulated it at the time, increases in aircraft performance, the unknowns of the flight regimes in which the aircraft were operating, and the complexity of the systems had forced upon them the "discipline of technology."⁷⁷

By late 1953 pilots had flown the D-558-II many times to speeds approaching Mach 2. While a Mach 2 flight would require careful piloting by Crossfield as well as special preparations on the part of the ground crew and planning by the engineers, the flight itself would not be a big leap. The team built the plan on everything it had learned from the earliest flights in the program.⁷⁸ This flight was carefully structured, with specific push-over times and descent angles laid out for Crossfield; the aircraft was given special attention in preparation of the flight, and quite importantly, the undertaking had the endorsement of Agency headquarters

⁷² Yeager and Ridley unofficially dubbed the project "Operation NACA Weep." Michael van Pelt, *Rocketing into the Future: The History and Technology of Rocket Planes*, (New York: Springer Praxis, 2012), p. 201. Yeager's dramatic increase in speeds was in sharp contrast to the incremental steps he took in the X-1 - proceeding from Mach .89 to Mach .91 and then Mach .92 in a methodical process.

⁷³ Yeager and Janos, *Yeager: An Autobiography*, pp. 192-193, 197. While the NACA flew experimental aircraft with a chase aircraft, this was not always the case with the Air Force. In June 1948 Glen Edwards and four crewmembers died in the YB-49 flying a series of tests on a Saturday, when no chase planes were available.

⁷⁴ Fred Stoliker, *Pulling Numbers Out of the Air—Data Processing in the Early 1950s: Performance Engineering Branch, Edwards AFB, California*, (Edwards, CA: Air Force Flight Test Center History Office, 1998), p. 21.

⁷⁵ Curtis Peebles, "Risk Management in the X-Planes Era: D-558-II vs. X-1A at Mach 2," *Quest* Vol. 11: Number 4, 2004, pp. 40-47; and Chuck Yeager pilot report and transcript, December 23, 1953, Air Force Flight Test Center History Office, Edwards Air Force Base, in Hallion, "Sweep and Swing: Reshaping the Wing for the Jet and Rocket Age" p. 40.

⁷⁶ Hubert M. Drake and Wendell H. Stillwell, *Behavior of the Bell X-1A Research Airplane During Exploratory Flights at Mach Numbers Near 2.0 and at Extreme Altitudes*, NACA RM H55G25, (September 1, 1955). Inertia coupling, also called "roll coupling," occurs when an aircraft whose mass is located in or along the fuselage, (the X axis, if you work at the AFRC), rolls and pitches simultaneously. When inertial forces exceed aerodynamic forces the aircraft oscillates violently around the two axes, sometimes to the point of destruction. Interestingly, it was while watching an X-1 spin model in flight at Langley, then looking at the flight data, that NACA engineer William H. Phillips began theorizing about inertia coupling. Malcom J. Abzug and E. Eugene Larrabee, *Airplane Stability and Control, Second Edition: A History of the Technologies that Made Aviation Possible*, Cambridge Aerospace Series 14, (Cambridge, UK: Cambridge University Press, 2002), p. 109. The X 1 could sustain 18gs without consequence.

⁷⁷ The term appears in Francis Duncan's *Rickover and the Nuclear Navy: The Discipline of Technology*, (Annapolis, MD: Naval Institute Press, 1990), a subject, which perhaps better than any other, encapsulates the requirements which certain technologies impose on those who use them if they wish to survive.

⁷⁸ Douglas test pilot Bill Bridgeman reached Mach 1.85 in June 1951 and Mach 1.88 in August of that year. Over the next two years he and Crossfield nudged the speed up to Mach 1.96 by October 1953. Peebles, "Risk Management in the X-Planes Era," p. 42; and Richard P. Hallion and Michael H. Gorn, *On the Frontier: Experimental Flight at NASA Dryden*, Second Edition, (Washington, D.C: Smithsonian Books, 2003), p. 391.

and the Navy, as well as the High-Speed Research Station management, all of whom were aware of the steps to be taken along the way. In place were procedures to ensure that, should something appear to jeopardize the flight, the attempt would be cancelled by predetermined requirements. Those same procedures the NACA used in this instance set the stage for the processes and procedures that NASA would use a decade later in the manned spaceflight program.

Yeager's X-1A incident was an example of going too far beyond the known in a single step and doing so without the participation of unvested parties. Neither Yeager nor Ridley knew about the risk of inertia coupling - still a theoretical phenomenon as late as 1953.⁷⁹ This meant the flight risk was higher than believed due to the unknown factor. Engineers from Bell Aircraft had warned that reduced stability might occur at high speeds but Yeager and Ridley were confident they would avoid that corner of the flight envelope. Remarkably, to break Crossfield's record Yeager decided to increase his top speed by nearly Mach 0.45 on each successive X-1A flight; the possibility of running into an aerodynamic or stability problem was quite large once he approached Mach 2, particularly in light of the Bell Corporation's warning. In contrast, the speed increase between Crossfield's October flight in the D-558-II and the Mach 2 flight in November amounted to only Mach 0.045. The incidents underscore the divergent approaches to flight research of the period: one old, one new.

Another incident was not as benign. In 1956 Air Force Capt. Milburn "Mel" Apt was assigned as a project pilot on the X-2. Although a very accomplished pilot, Apt had no rocket plane experience whatever, but for his very first flight in the X-2 he was to follow an "optimum maximum energy flight path." If successful, he would be the first to fly Mach 3. The flight was scheduled for September 27 and the Air Force was set to relinquish the aircraft to the NACA three days later. The drop from the B-50 launch aircraft went well and Apt flew the flight profile perfectly. At the peak altitude of 65,500 feet (19.96 km) he pushed over and reached Mach 3.2. Not long after, the X-2 glide flight began and Apt turned back toward the lakebed, whereupon inertia coupling sent the aircraft out of control. He tried to recover, could not, separated the escape segment from the fuselage but was unable to complete the rest of the escape procedure before the segment hit the ground.⁸⁰ Apt died on impact.

Rocket planes were not the only hazard to a pilot's life: on one flight in the F-100A, which Crossfield flew to help solve the inertia coupling problem then plaguing the type, inertia forces were so severe that he suffered a cracked vertebra in his neck. He described the X-5 as "a three-wheeled automobile. It was loose and danced crazily," and when he stalled it unintentionally "a kaleidoscope of brown desert, blue sky, and white clouds passed my windshield as the X-5 wound up steadily towards the desert floor. I pressed the stick hard to forward left and bent on full right rudder - the prescribed spin recovery maneuver - but the X-5 stubbornly refused to conform." It took 10,000 feet (3 km) of altitude to recover. That he flew experimental rocket planes

⁷⁹ The first suggestion of the aerodynamic phenomenon appeared in 1948 with the publication of William Hewitt Phillips' "Effects of Steady Rolling on Longitudinal and Directional Stability," NACA TN-1627, June 1948. Technical Notes were for "the results of short research investigations and the results of studies of specific detailed problems which form parts of long investigations;" few paid much attention as a consequence. On October 27, 1954 NACA pilot Joe Walker was flying the Douglas X-3 when he first experienced the violence of inertia coupling: the aircraft endured $-6.7/+7gs$ in the span of .5 seconds and was grounded for 11 months. After the phenomenon emerged with the X-3, an instrumented aircraft that afforded real study, some of Phillips' colleagues jokingly said he'd brought on inertia coupling simply by writing about it. *Flight Experience with Two High-Speed Airplanes Having Violent Lateral-Longitudinal Coupling in Aileron Rolls*, [n.a.] NACA RM H55A13 (Edwards, CA: NACA High-Speed Flight Station, 1955), p. 4; and Abzug and Larrabee, *Airplane Stability and Control*, p. 109. See also Edwin J. Saltzman and Theodore G. Ayers, *Selected Examples of NACA/NASA Supersonic Flight Research*, NASA SP 513, (Edwards, CA: NASA Dryden Flight Research Center, 1995), p. 11.

⁸⁰ Apt had flown the X-2 simulator, a Goodyear Electronic Differential Analyzer (GEDA), but it was a motionless, ground-based system with limited verisimilitude. Gene Waltman, *Black Magic and Gremlins: Analog Flight Simulations at NASA's Flight Research Center*, (Edwards, CA: NASA Dryden Flight Research Center, 2000), pp. 6-9. Apt was an accomplished test pilot familiar with inertia coupling, having flown research flights in 1955 in the F-100A to help solve the problem. The X-2's escape system, like that of the D-558-I and -II, required the pilot to jettison the nose section of the aircraft (that included the cockpit), but there the similarities ended. The Douglas aircraft required the pilot, once clear of the fuselage, to release his seat back, which allowed him to fall backward out of the cockpit, after which he could open his parachute. In the X-2, once the nose section was clear of the fuselage the pilot had to jettison the canopy, climb from the cockpit (the nose section was now slowed by a drogue chute), jump free and use his own parachute to continue his descent. Richard E. Day, *Coupling Dynamics in Aircraft: A Historical Perspective*, NASA-SP-532, (Edwards, CA: NASA Dryden Flight Research Center, 1997), p. 8. Day referred to the events of that day as "predestined doom." Said Crossfield about the escape systems in the D-558-I and -II, aircraft he flew: "This is the way to commit suicide to keep from getting killed. If you could make a capsule that was good enough to live through the emergency, you might as well fly it and throw away the airplane." A. Scott Crossfield, interviewed by Peter Merlin, February 3, 1998, NASA Armstrong Flight Research Center Oral History Collection.

(with volatile fuels and impossible escape systems) and so many different experimental jet aircraft (whose flight characteristics were sometimes unforgiving) and survived is a testament to the systematic approach the NACA Center in the desert developed to deal with risks, the unknowns of flight, and new technological systems.⁸¹

The demands of the X-planes, the aircrafts' often poor flight characteristics and stability problems, schedule pressure, and occasional crushing errors in judgment, all pointed to an overlooked aspect of early supersonic flight and flight research in general in the period. The challenges were not just about engineering and aerodynamics or the courage to face the risks: they were also about how to do dangerous things as safely as possible.

More than any other program, the X-15 refined this process to an art. Dubbed Round Two of the NACA's and military's three-round progression in high-speed and high-altitude research aircraft, the rocket plane had a top speed close to Mach 7 and could reach altitudes above 50 miles (80.5 km), putting it into space (as defined by the U.S. military).⁸² Its flight profile echoed earlier rocket plane research flights at Edwards but was much

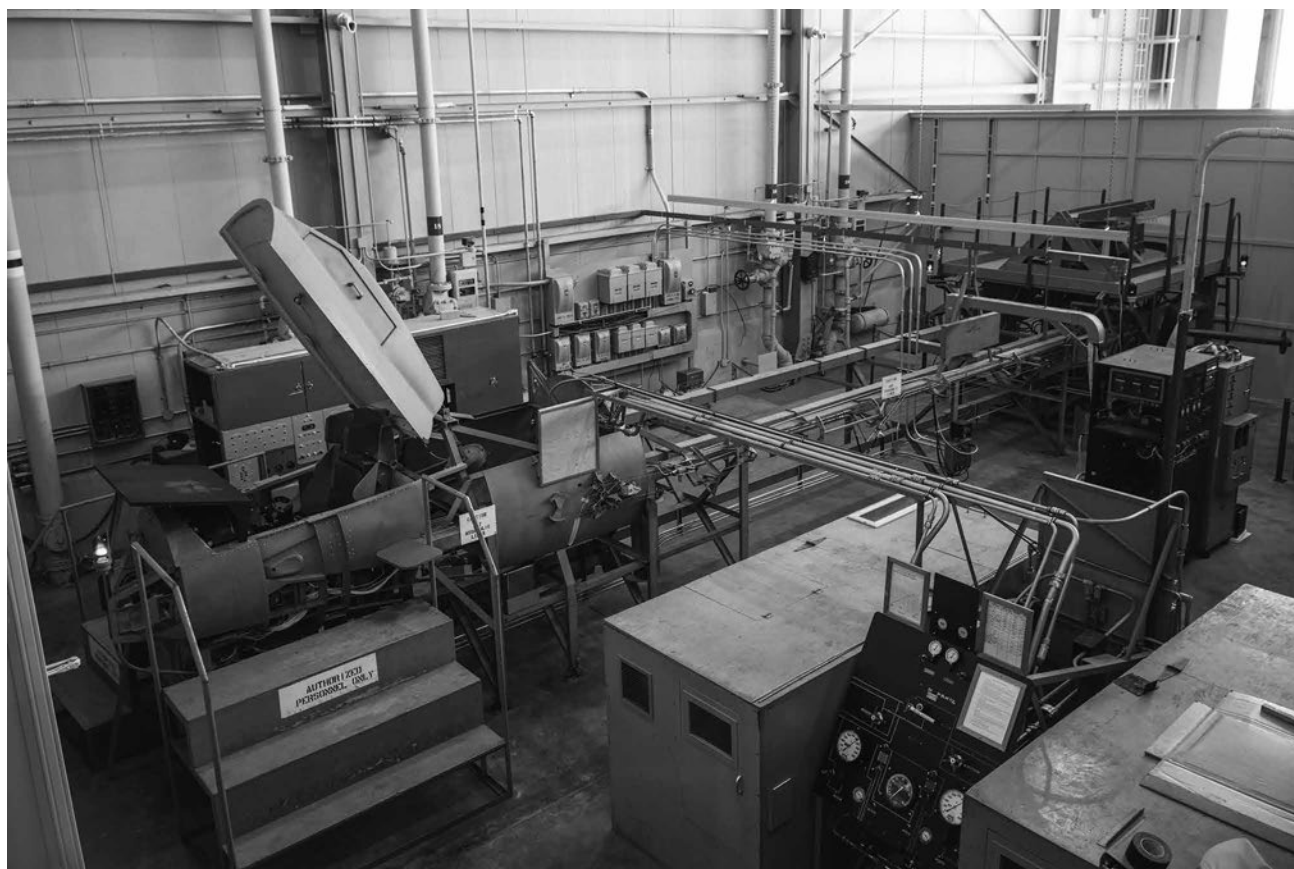

The X-15 flight simulator. NASA E 6910

⁸¹ A. Scott Crossfield with Clay Blair, Jr., *Always Another Dawn: The Story of a Rocket Test Pilot*, (New York: Arno Press, 1972), pp. 155, 198. Crossfield would add to his rocket plane flights by testing the X-15, bringing his total to 114 flights - the absolute record.

⁸² It is a measure of the NACA's and NASA's success in this realm that only two pilots at the desert location lost their lives flying experimental research flights between 1946 and 1966 - the critical period of procedural development. In that same period, the Air Force at Edwards lost some 100 souls to aircraft accidents. And while there were more Air Force personnel and aircraft than NACA/NASA personnel or aircraft at the base, the figures, along with the aforementioned examples, are indicative of the divergent patterns at the time. Between 1947 and 1961 the NACA/NASA research facility at the base completed 212 piloted rocket plane flights without a fatality. (Aborts, which could be more dangerous, are not included in this figure.) By 1975 the Center had paired with the Air Force on a number of rocket plane projects, bringing this total to 495 including 12 flights to space and back with the X-15 (with one fatality). Gelzer, "Casualty White Paper;" and Hallion and Gorn, *On the Frontier*, pp. 378-419.

The demarcation of space is somewhat arbitrary even today. In the 1950s a group led by von Kármán met to determine where the line should be. Speaking for the group, he offered 100km to the FAI as "a nice round number everyone could agree on." At this altitude there was no longer sufficient atmosphere for an aerodynamic shape to generate lift or control by means of its aerodynamic surfaces. Only exceeding orbital velocity would keep such a vehicle "flying." Despite the lighthearted phrasing there was logic behind the number, even if at the time that logic relied on theory, not evidence. http://www.slate.com/articles/news_and_politics/

more demanding. A pilot in the X-15 would typically drop from the B-52 carrier aircraft over eastern Nevada or southern Utah, fly the research mission, and land back on Rogers Dry Lake, all within 10-11 minutes (including visits to space).⁸³ Earlier rocket planes were launched while flying parallel to the immense dry lake, within gliding distance of its safety: in the event of an engine problem the pilot jettisoned propellant and glided to a landing on the 44-square mile (114 km sq) dry lakebed. If things went according to plan, the flight profile took the rocket plane past the world's largest lakebed; once the test was complete he turned back toward the lakebed and glided to a landing. The first aircraft to push the limits of this profile was the X-2: because of its speed it could barely make it back to Rogers Dry Lake and on its final flight it did not.⁸⁴ Clearly, the procedures needed to fly the X-15 safely had to be more detailed compared to those of previous X-planes.

The flight simulators for the X-15 were the first to play “a major role in the development of an aircraft and its flight profile.”⁸⁵ The X-15's simulators, built by North American Aviation, were six-degree-of-freedom, analog systems linking pilots, controller, and systems engineers at the Center. After enough simulations to

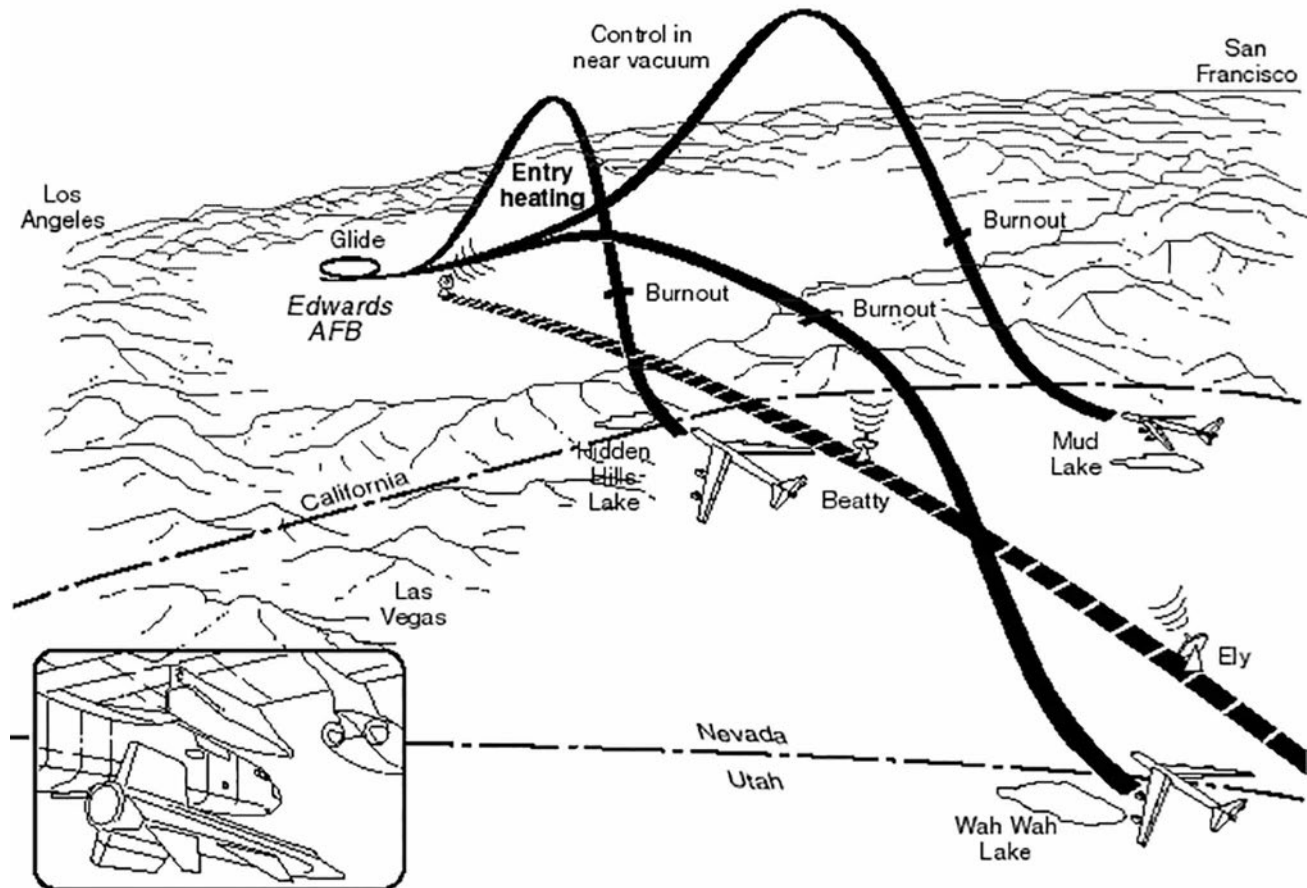

The X-15 Flight Profiles

be familiar with a normal flight, anomalies were introduced for all parties to grapple with. “We would go down [to NAA], maybe three days a week, to do flight planning and stability and control analysis. I did all the envelope expansion flight planning on the X-15 before it ever flew,” recalled Richard Day.⁸⁶ Simulations benefitted from digital computers that predicted temperature during a flight, and these, too, were factored into

explainer/2004/09/where_does_space_begin.html, accessed Aug. 14, 2018.

⁸³ Joe Walker’s high-altitude flight took him 67 miles vertically and 294 miles horizontally: he was on the lakebed at Edwards 11 minutes 8 seconds after release from the NB-52B.

⁸⁴ Investigators concluded that the X-2’s speed on this flight was a contributing factor in the accident: concerned about how far he was from the lakebed by the time he reached his top speed, Apt made an abrupt turn back to the lakebed, initiating the onset of inertia coupling. Peter Merlin, “50th Anniversary of Two Historic X-2 Milestones Celebrated,” <http://www.nasa.gov/centers/dryden/news/NewsReleases/2006/06-34.html>, accessed January 19, 2012.

⁸⁵ Dennis R. Jenkins, *X-15: Extending the Frontiers of Flight*, (Washington, D.C.: NASA, 2007), p. 276.

⁸⁶ Richard E. Day, “Cold War Jets Study (A Legacy Resource Management Project) Edwards AFB, Kern County, California, Oral History Transcript, (Edwards, CA: Computer Sciences Corporation, 1995), p. 17. Limited Distribution.

simulations. Pilots and engineers used the simulators to practice aspects of flights and emergencies as well as whole missions. For a far-ultraviolet spectral range experiment to be flown for the University of Wisconsin - a task that required keeping the aircraft within +/-5 degrees of a set position for as long as possible – the team rehearsed aircraft control and acquisition of sidereal targets over and over until satisfied the pilot could perform the tasks.⁸⁷ In another instance, pilots flew simulations to determine how much dynamic pressure the X-15 could handle before the reaction control system was no longer effective: 100 lb/sq ft (.448 kN/.09 m sq) was no problem, concluded NACA engineer Richard Day.⁸⁸ So comprehensive were the simulators that flight planners used them to anticipate thermal loads, abort issues, technical problems in flight, and even examine the consequence of technical changes to the aircraft and its systems before such changes were made.⁸⁹ Responding to pilots' comments about how fast things happened in the X-15, project engineer and flight planner Jack L. Kolf created what is likely the first "fast time" simulation, in which the flight was accelerated by about 50%. Pilot Milt Thompson, for one, felt this better represented actual flight conditions.⁹⁰

The NACA had technical direction of the X-15 project even though the Air Force and Navy were partners. Once the manufacturer's acceptance flights were complete, NASA (est. October 1958 when the NACA transitioned to NASA), Air Force, and Navy pilots began high-speed and high-altitude flights. These flights would not be carried out in large leaps, as the Air Force had done with some other X-planes, but as step-by-step, incremental processes.⁹¹ The X-15's long flight path meant a new approach to emergencies such as an engine failure. Part of the safety system was a flight path that roughly followed a string of dry lakebeds from the launch point to Edwards, providing emergency landings sites for the aircraft all along its route.⁹²

Supporting actual flights were two ground stations located along the aircraft's flight path, built specifically for the program and staffed with Center personnel to monitor the flights. The corridor within which the flights took place was some 50 miles wide and 485 miles long, and was eventually dubbed the High Range; the two ground stations - essential if the control room at the Center were to track the aircraft throughout its flight - provided engineers and controllers with constant, real time data.⁹³ Located within the High Range, near Beatty and Ely NV, the ground stations had radar and received telemetry data—including velocity, elevation, azimuth, and range—enabling the engineers to monitor subsystems on board the X-15 and advise the pilot, help position the launch aircraft for release, time the X-15 engine start as a back-up to the pilot, and, perhaps most importantly, direct emergency response should the pilot need to abort the mission and land out. The ground stations provided uninterrupted coverage from Wendover AFB, UT, to Edwards AFB. The X-15 relay stations were planned for and set up before any human took an orbital trip into space. Gerald "Jerry" Truszynski, one of the Center's early engineers, led the effort to design and set up the stations; fittingly, he eventually transferred to NASA HQ where he served as the Associate Administrator for the Office of Tracking and Data Acquisition, established to monitor Mercury and similar spacecraft.⁹⁴

And since the X-15 was an exo-atmospheric rocket powered aircraft - the first in every sense - engineers at

⁸⁷ "NASA FRC Report on Research of Interest to the NASA Committee on Missile and Space Aerodynamics, January 30-31, 1961," [n.a.], Armstrong Flight Research Center Historical Reference Collection, L1-7-1B-4, L1-9-1A-4, and Joseph Weil, compiler, *Review of the X-15 Program*, NASA TN D-1278, (Edwards, CA: NASA Flight Research Center, 1961).

⁸⁸ Report on RCS simulation, Richard D. Day, May 5, 1959, L1-7-1B-4, AFRC Historical Reference Collection.

⁸⁹ In a presentation to the Society for Experimental Test Pilots, Milt Thompson told of a cautionary side to simulators, of switches and instruments whose actions or locations were reversed when it came to the actual aircraft, and control systems on the aircraft that could be saturated in flight and rendered ineffectual but which did not behave so in the simulator until flight data were added. Milton Thompson, *General Review of Piloting Problems Encountered During Simulations and Flight of the X-15*, SETP Symposium, Beverly Hilton, Los Angeles, 1966.

⁹⁰ Milton O. Thompson, *At the Edge of Space: The X-15 Flight Program*, foreword by Neil A. Armstrong, (Washington, D.C.: Smithsonian Institution Press, 1992), p. 72.

⁹¹ Driven by exigencies of the Cold War, the military test programs eschewed a conservative approach in favor of expedience. Despite the compelling argument for a need of hypersonic data of all kinds, the X-15 program would be conducted at the NACA's—and then NASA's—pace.

⁹² Robert. G. Hoey and Richard E. Day, "X-15 Mission Planning and Operational Procedures," in *Research Airplane Committee Report Conference on the Progress of the X-15 Project*, 1961, pp. 155–169.

⁹³ Charles V. Eppley, *The Rocket Research Aircraft Program, 1946-1962*, Technical Document Report No. 63-3, (Edwards, CA: U.S. Air Force Flight Test Center, 1963), p. 19.

⁹⁴ Some engineers vied for the chance to staff the remote sites for flights because they offered the chance for entertainment not available in California. For more on X-15 elements that featured in the space shuttle see Jenkins, *X-15: Extending the Frontiers of Flight*. See also Linda Neuman Ezell, *NASA Historical Data Book, Vol. II: Programs and Projects, 1958-1968*, (Washington, D.C.: NASA, 1988), pp. 522, 524.

the Center developed experience with vehicles and systems exiting the atmosphere, the rigors of space flight, reaction control systems, and atmospheric flight on re-entry—the first reusable spacecraft.⁹⁵ For example, the Air Force delved into a “self adaptive flight control system” in 1956 and began in-flight testing of the concept using a Lockheed F-94 and a McDonnell F-101 the following year. As a product of this work, X-15-3 flew with a Minneapolis-Honeywell MH-96 adaptive flight control system (AFCS) beginning in 1961.⁹⁶ This system, the first of its kind on any winged reusable spacecraft, operated throughout the X-15’s flight envelope, from an “altitude of 354,000 feet [107.9 km] and a maximum velocity of 5660 feet per second [1,725 m/s] [through dynamic pressure variations of] 0 to approximately 1889 pounds per square foot [8.4 kN/.09 m sq].”⁹⁷ The AFCS provided variable control gains for the pilots of an aircraft or spacecraft that flew through a stunning range of speeds, altitudes, and dynamic pressures, and that underwent a dramatic change in stability characteristics during a very short flight. The AFCS gave the pilot “no change in stick force, stick position, or aircraft response to control inputs” regardless of how fast or slow, heavy or light, or where in (or out of) the atmosphere the X-15 might be.⁹⁸ With an adaptive flight control system, notes Dennis Jenkins, “a given movement of the control stick would always result in the same airplane response regardless of how far the control surfaces had to move to accomplish the maneuver.”⁹⁹ The AFCS, like much from the X-15 research program, would transfer to the space shuttle program as well as to other aircraft. Still another example of this transferrable research and data was the first in-flight physiological data collection of a pilot in a full-pressure suit, performed both from another aircraft and on the ground in 1960. The pilot wore a variety of biomedical and bio-astronautical sensors that sent data in real time to flight surgeons. These data enabled researchers to say with satisfaction that spaceflight posed no biological or physiological barrier to humans, a concern that had persisted despite animal testing conducted in the preceding decade.

The Center developed a control room for the X-15 that accommodated engineers from all the key areas involving a flight - a group that operated under explicit guidelines governing in-flight events and which had only one individual communicating with the pilot during a flight. For a full decade and more prior to the challenge to reach the moon, the NACA/NASA had been flying aircraft from what are now Armstrong Flight Research Center and Edwards Air Force Base powered by rocket engines and flown by pilots. “This experience has provided information that may be applicable to the entry problems of orbital vehicles,” wrote Euclid Holleman and Elmor Adkins in 1964.¹⁰⁰ It is no surprise that the mission control rooms for Mercury and subsequent manned space flights were patterned directly after the X-15 control room: no other facility in the Agency had that experience.¹⁰¹ “The X-planes of the 1950s, especially the X-15,” noted Roger Launius and Dennis Jenkins, “proved critical to advancing re-entry and recovery technologies for space flight.”¹⁰² By the end of the program the three X-15s had spent “nearly six hours above Mach 4, and 82 minutes above Mach 5”, the only piloted, winged vehicle to do so until the space shuttle.¹⁰³

The amount of data the X 15 research flights produced also meant a necessary change in how the data were collected. Rather than simply recording telemetry data on the ground for later analysis, or relying on film to record on-board instrumentation readings, engineers in the control room looked at strip charts displaying critical telemetry from the X-15 in real time. Now, if a problem arose in flight an engineer could immediately notify the test conductor, and the information could be passed to the pilot. Mission rules established beforehand determined what action to take in each specific situation. And there were rehearsals for the actual flights, with the engineers in the control room monitoring the systems while the pilots flew the simulator located elsewhere in the Center. (By one account, pilots could fly close to 100 hours of practice missions in the simulator for a flight that might

⁹⁵ NASA pilot Joseph A. “Joe” Walker became the first human to visit space three times, doing so in the X-15.

⁹⁶ Staff, *Experience with the X-15 Adaptive Flight Control System*, NASA TN D-6208, (Edwards, CA: NASA Flight Research Center, 1971), p. 2.

⁹⁷ *Experience with the X-15 Adaptive Flight Control System*, p. 22.

⁹⁸ *Experience with the X-15 Adaptive Flight Control System*, p. 18.

⁹⁹ Jenkins. *The X-15: Extending the Frontiers of Flight*, p. 494.

¹⁰⁰ Euclid C. Holleman and Elmor J. Adkins, “Contributions of the X-15 Program to Lifting Entry Technology,” *Journal of Aircraft*, Vol. No. 1, No. 6, November-December 1964, pp. 360-366.

¹⁰¹ It is also no surprise that the first director of the NACA Muroc facility, Walter C. “Walt” Williams, moved to Houston to join the Manned Spacecraft Center, later the Johnson Space Center: his experience was invaluable to the new Agency.

¹⁰² Roger D. Launius and Dennis R. Jenkins, *Coming Home: Reentry and Recovery from Space*, (Washington, D.C.: NASA, 2011), p. ix.

¹⁰³ T. A. Heppenheimer, *The Space Shuttle Decision: NASA’s Search for a Reusable Space Vehicle*, (Washington, D.C.: NASA, 1999), p. 44.



The Flight Research Center's X-15 control room, which served as the template for all subsequent NASA spaceflight control rooms. To the left and right are rows of consoles where flight test engineers sat, each with specific instruments to monitor. Telephones at the consoles gave them quick access to engineers elsewhere on the center if need arose. Behind the man in the cardigan sweater (center) is a vertical plotting table which allowed all in the room to watch the X-15's flight in real time. Standing at the front of the room with his left hand on his hip is Air Force Maj. William J. "Pete" Knight. As the only X-15 pilot in the room, he served as NASA-1, what the space program would later call "capcom" (capsule communicator), the only controller that spoke with the pilot of the X-15. The large wastebasket-looking box on top of the vertical plotter is a speaker, broadcasting radio communications from the NB-52B mothership as well as the X-15 and chase aircraft. NASA E66-15774

last 11 minutes.¹⁰⁴) The pilots also flew practice approach and landings in a Lockheed F-104 before an actual flight because the X-15 would be without motive thrust at that point and its landing pattern was the most extreme ever designed at the time; the Starfighter was a good analog. (Milt Thompson described a deadstick F-104 as an aerodynamic brick.) Before flying the mission, a technical briefing involving all participants took place to review the mission and the alternative landing lakebeds, as well as the mission rules themselves. These rules were never changed or violated during a mission although it was sometimes tempting to do so.

NASA X-15 pilot William H. "Bill" Dana recalled an example of both flight planning and the value of absolute rules governing flights:

The X-15, at whatever instant in its flight, needed a safe place to land. If [we] planned to fly to a speed of Mach 3 or less, only one landing lake was needed. The X-15 launched over the destination lake (always Edwards for such a speed) and, if the engine did not light or did not provide sufficient impulse to reach the desired end conditions, the airplane landed [back] at the destination lake. For flights intended to fly faster, the airplane could not get back to the destination lake from flight conditions above Mach 3. Two lakes were needed; the destination lake, and a launch lake in case the engine did not provide enough impulse to allow the airplane to reach the destination lake. As speeds increased, two lakes were not enough. The engine could shut down after too much speed was achieved to return to the launch lake, but prior to providing enough speed for the X-15 to reach its destination. A so-called intermediate lake was provided, between the launch lake and Edwards. By the time Mach 5 flights were

¹⁰⁴ William H. Dana, oral history interview, NASA Armstrong Flight Research Center Oral History Collection.

being planned, three intermediate lakes were required.

At a meeting [I attended] some pilot or engineer was proposing to eliminate the requirement for a certain intermediate lake, probably because that lake was wet and unusable and its absence from the “available” list was preventing a research flight. The program, [he] proposed, would just overlook the need for that lake. “After all,” he argued, “we’ve never had a mid-boost shutdown.” (All engine failures up to that time had been immediately after launch, none in mid-boost.)

[Center Director Paul] Bikle ended the discussion succinctly: “All that means is that we’re overdue.”

I noted with interest that in the next three years the X-15 experienced three mid-boost shutdowns.¹⁰⁵

“The mission rules [for spaceflight] are established,” a NASA representative explained to members of Congress in 1962, “to take into account every conceivable situation that could occur on board the spacecraft. [referring to Mercury] It was felt...borne out by flight experience, that such a set of rules were an absolute necessity.”¹⁰⁶

The entire fleet of rocket planes flown for nearly three decades from the desert base generated an expanding body of experience and knowledge of rocket motors, high-speed flight, energy management with low L/D aircraft, volatile propellants, reaction controls, and high altitude safety measures including those involving human physiology which, when combined, existed at no other NACA/NASA Center by 1960.¹⁰⁷ “When Cape Canaveral fuels a missile, practically everyone can take shelter in a blockhouse,” wrote X-15 pilot Joe Walker, “but our crew at Edwards must be out in the open,” underscoring the trove of experience the team at the Flight Research Center had developed dealing with risk.¹⁰⁸

To be sure, the NACA had been developing rocket experience on the other side of the continent. Established in mid-1945, the Agency’s Pilotless Aircraft Research Station (PARS) on Wallops Island, VA served as a launch site for sounding rockets carrying small-scale research models at transonic and supersonic speeds.¹⁰⁹ An adjunct of Langley and renamed the Pilotless Aircraft Research Division (PARD) in 1946, its portfolio grew to include hypersonic research when, in 1952, the NACA Committee on Aerodynamics asked the Agency to begin research into the problems of flight at speeds between Mach 4 and Mach 10 and altitudes up to the stratosphere. Rockets became much more than methods of accelerating models: they became the experiments themselves and a major activity at PARP. Indeed, members of the hypersonic team were so enthusiastic with the results of their analysis suggesting the favorable possibilities of human space flight that their conclusions and recommendations had a definite orbital-flight flavor.¹¹⁰ In the spring of 1958 Langley’s Max Faget attended an NACA-sponsored High-Speed conference at the NACA Ames Research Center where he presented a paper on the very topic: “Preliminary Studies of Manned Satellites—Wingless Configuration: Nonlifting” [sic]¹¹¹ With the launches of Sputniks 1 and 2, the creation of NASA, and the initiation of Project

¹⁰⁵ William H. Dana, correspondence with Christian Gelzer, January 6, 2003. Center Director Paul Bikle was a veteran flight test engineer who began his career working for the Army Air Forces during WWII. He served as the Technical Director of the Flight Test Engineering Laboratory at Edwards Air Force Base before assuming the helm of the new NASA Center at the base, in 1959.

¹⁰⁶ *Manned Spaceflight Program of the National Aeronautics and Space Administration: Projects Mercury, Gemini, and Apollo*, Staff Report of the committee on Aeronautical and Space Sciences, United States Senate, September 4, 1962, (Washington, D.C.: U.S. Government Printing Office 1962), p. 96.

¹⁰⁷ As early as 1959 engineers at the Center were writing formal papers about their experiences with energy management and rocket planes. Hubert M. Drake, *Energy Management Requirements of Entry Vehicles*, NASA Conference on Review of NASA Research Related to Control Guidance and Navigation of Space Vehicles, NASA Ames Research Center, February 25 27, 1959.

¹⁰⁸ Joseph A. Walker, “I Fly the X-15,” *National Geographic*, 122, No. 3 September 1962: p. 446.

¹⁰⁹ Sounding rockets carry instruments to sub-orbital altitudes. The term is nautical in origin, suggesting sampling.

¹¹⁰ Shortal, *A New Dimension*, 288. On 24 January 1958 PARP submitted a confidential 10-page report, “A Proposed Simple Means for Manned Space-Flight Research,” to Langley management. The proposal called for a series of sub-orbital missions to be launched from Wallops. A piloted capsule would be boosted to an altitude of 100 to 200 miles by a solid-fueled rocket, make a parachute-slowed splashdown in the Atlantic, and be refurbished and reused. The group suggested the rocket, a cluster of seven Sergeant motors, be fired in stages of four, two, and one, with the second and third stages to be fired “at the pilot’s discretion.” Harold D. Wallace, Jr., *Wallops Station and the Creation of an American Space Agency*, (Washington, D.C.: NASA, 1997), chapter 3, <http://history.nasa.gov/SP-4311/ch3.htm>, accessed July 28, 2015.

¹¹¹ Maxime A. Faget, Benjamin J. Garland, and James J. Buglia, “Preliminary Studies of Manned Satellites—Wingless Configuration: Nonlifting,” in *NACA Conference on High-Speed Aerodynamics, A Compilation of Papers Presented*, Ames Aeronautical Laboratory, Moffett Field, Calif., March 18, 19, and 20, 1958, (Moffett Field, CA: NACA, 1958), pp. 19-34.

Mercury, much of the rocket testing techniques developed at PARD transferred to industry and the NASA space program, and many of the engineers who first populated the new space program or went to industry were veterans of Wallops - hardly surprising, since everything being tested from PARD was lofted by a rocket even if the subject of study was not a rocket. In that respect, PARD developed deep experience with, and reams of data about, rockets - most of them small but powerful.

Yet the PARD engineers had no experience with human factors. Their data were telemetered and the sources periodically failed in flight, leaving the experiment an inert object to splash into the Atlantic Ocean, unrecovered. The engineers had no experience developing or gathering data from piloted rockets and none with life support systems aboard such vehicles. As a result, they had no experience dealing with redundancies, failsafe mechanisms, large, controlled internal environments, or the complex control systems and subsystems necessary for human rocket flight. In short, they were unprepared to keep pilots alive during exo-atmospheric flight, to deal with g-forces and zero g, and were unfamiliar with the importance of inerting the cockpit atmosphere or why, what instruments a pilot would need when flying outside Earth's atmosphere or how to maneuver in the absence of dynamic pressure. As Hubert Drake, Donald Bellman, and Joseph Walker, all from the HSFS, noted in their paper read at the Ames conference, "the presence of the human in the orbital vehicle requires that malfunctions be either nondestructive or such that an escape system can provide survival. The presence of propellants, the take-off operation, stage separation and ignition, and high dynamic pressure combine to make the launch operation the most critical escape region." These were observations drawn from experience they and others at the Center were gaining daily. A human in the spacecraft reduced on-board automation and "increase[d] reliability," they added.¹¹² Three other authors from the HSFS told the audience (quite likely the largest and most august gathering of minds devoted to spaceflight up to that point in the U.S.) of their research in the previous three-plus years in reaction control systems. In their testing they'd used "control systems for *orientation as well as stabilization*," demonstrating elements of human spaceflight the engineers at PARD had not begun grappling with.¹¹³ That was the purview of the NASA Center in the High Desert of California that had been flying rocket planes since 1947 with pilots at the controls. By the time president Dwight D. Eisenhower remade the Agency in 1958 and shifted its focus to space, the HSFS was the only Center with human/rocket experience - the only Center with relevant experience for vehicles that flew into space and then flew again once back in the Earth's atmosphere.

What emerged during this critical period was an agency going through dramatic change in a very short time. This transition was marked by a growing facility with new technology, an appreciation for how to balance risk and results, and a return of the Agency to the van of aerospace research. Much of that change came at the hands of the people working at the NACA's outpost in the Mojave Desert and is, in this context, the foundation for human spaceflight. It's unlikely that any from the NACA who came west in 1946 to work on the X-1 foresaw this in their future, at least not initially. Yet their gathering experience with the new tools translated into direct, critical, if unwitting, contributions to events after 1957.

Emblematic of the Center's significance to the Agency's future is, again, Scott Crossfield who between 1950 and 1955 made 99 flights in the rocket powered X-1 and the D 558-II - roughly 20 rocket flights per year.¹¹⁴ Meanwhile he was flying the propeller driven F-51D, the jet-powered D-558-I, X-4, X-5, XF-92A, YF-84, F-84F, F-86F, F 9F, B-47A, F-100A and YF-102.¹¹⁵ And he was not singular.

¹¹² Hubert M. Drake, Donald R. Bellman, and Joseph A. Walker, *Operational Problems of Manned Orbital Vehicles*, NACA RM H58D21, (Edwards, CA: NACA High-Speed Flight Station, 1958) p. 2-3, <http://naca.central.cranfield.ac.uk/reports/1958/naca-rm-h58d21.pdf>, accessed June 22, 2016. See also "Operational Problems of Manned Orbital Vehicles," in *NACA Conference on High-Speed Aerodynamics. A Compilation of Papers Presented*. March 18, 19, and 20, 1958. Moffett Field, CA: NACA, Ames Aeronautical Laboratory, 1958. For example, almost every rocket plane flown at the Center had a cockpit atmosphere of pure nitrogen, starting with the X-1. "An oxygen atmosphere was considered in the original design discussion of the X-15. However, the idea was abandoned on the basic [sic] of fire hazard inside the cockpit and out." Walton Jones letter to Floyd Thompson, Chairman, Apollo 204 Review Board, February 24, 1967, containing memo "Comments on Cockpit Environments Used in Research Airplanes at the Flight Research Center," February 8, 1967, AFRC Reference Collection.

¹¹³ Euclid C. Holleman and Wendell Stillwell, "Simulator Investigation of Command Reaction Controls," *NACA Conference on High-Speed Aerodynamics, A Compilation of Papers Presented*, Ames Aeronautical Laboratory, Moffett Field, Calif., March 18, 19, and 20, 1958, (Moffett Field, CA: NACA, 1958), p. 158.

¹¹⁴ Hallion, Gorn, *On the Frontier*, pp. 382-395.

¹¹⁵ It is important to locate the pilots in this construct as only the most visible actors in a much larger undertaking; far too often they and their accomplishments—and survival—become the story. Largely invisible are the engineers from a host of disciplines, mechanics and technicians, women computers, administration, and various support groups without whom no flight would take place.

The demands of flight research with the X-planes changed the very nature of the NACA. No longer was it just an agency involved in research and development; it had to be an operational agency as well, for it had to oversee the design, development, testing, and flying of exotic, dangerous, and difficult things which it would itself use.¹¹⁶ By the time the members of the SETP gathered for their first official banquet in October 1957, a decade after Yeager's Mach 1 flight, the horizon of human spaceflight lay ahead. When the U.S. formally committed itself to space exploration, and then human spaceflight, the Center in the High Desert was the only one actually prepared for the next step. Even after the Agency committed to the space shuttle a decade and a half later, it remained the only Center with experience flying a winged vehicle back from space.

¹¹⁶ Hallion, Gorn, *On the Frontier*, p. 44. See also Vincent N. Capasso Jr.: *Space Shuttle Related Maintenance Experience with the X-15 Aircraft*, NASA TM X-52876, in *Proceedings of the Space Transportation System Technology Symposium*, Vol. 6, July 15-17, 1970, as an example of X-15 experience deemed directly relevant to the space shuttle program.

Development

4: Development of Reaction Control Systems

Christian Gelzer
Logical Innovations, Inc.
NASA Armstrong Flight Research Center

Abstract:

Because the X-15 would fly at a lower dynamic pressure than any other aircraft then in existence, an alternative to aerodynamic control surfaces was needed. Engineers at the AFRC design and develop a reaction control system which they tested on the ground and in flight. It is used on the X-15 and Mercury spacecraft, and reaction control systems appeared on all human rated spacecraft after that.

Keywords:

Hydrogen peroxide; Hellmuth Walther; Richard Day; Neil A. Armstrong; YF-104; X-1B; Lunar Landing Research Vehicle

Simulations

Electronic computing arrived at Edwards Air Force Base in 1954 - the same year the NACA High-Speed Flight Station moved into its new facilities on the west side of Rogers Dry Lake. That year, the Air Force acquired a Goodyear Electronic Differential Analyzer (GEDA) analog computer to develop flight simulations for the Bell X-2.¹¹⁷ The GEDA would eventually be used to help sort out issues of inertia coupling that surfaced on that aircraft.¹¹⁸ In an analog computer, voltages are used to represent the values of different quantities. Zero volts might be sea level while 100 volts might then equal 100,000 feet (30.48 km). For angle of attack, zero volts might represent zero degrees, and 100 volts might represent 10 or 15 degrees, or perhaps 90 degrees; assigned values depended on the aircraft being simulated. The arrangement was not all-or-nothing; variations in the voltage allowed simulation of different altitudes or angles of attack.

In that same year the Air Force provided the NACA's Richard Day, Joe Weil, Donald Reisert, Wendell Stillwell, and several other engineers access to the GEDA. When programmed appropriately the computer (in that era the engineers would "mechanize" the computer) became the most sophisticated simulator available.¹¹⁹ Having no comparable computer, the engineers wanted the GEDA in order to conduct a study of a reaction control system (RCS) - small thrusters that would fire to stabilize or redirect an object in a near vacuum. All this was unknown territory in control system design - propellant usage, effects of system lag, control effectiveness, and even how the control stick should work. Day, Weil, Reisert, and Stillwell developed a simulation of the Bell X-1B as the platform, which was to be used in the actual RCS research flights. The tests were set to simulate operation in the absence of dynamic pressure (space); to simplify the implementation, the value of dynamic pressure (referred to as "q") was initially set at zero pounds per square foot (psf).

Driving their research was Air Force Project 1226 (which would be identified as the X-15 in January

¹¹⁷ The author presented a version of this chapter at the NACA Centenary: A Symposium on 100 Years of Aerospace Research and Development, March 3-4, 2015, National Air and Space Museum, Smithsonian Institution.

Gene L. Waltman, *Black Magic and Gremlins: Analog Flight Simulations at NASA's Flight Research Center*, (Edwards, CA: NASA Dryden Flight Research Center, 2000), quoting Richard Banner, p. 136. Goodyear's Astrophysics department, a branch of Goodyear Aircraft, developed the first version of the GEDA for the Air Force in 1949. It continued to refine the computer over the years, offering the L-2/N-2R2 in 1951 and the L-3/N-3R3 in 1953, for example. L stood for linear, N for nonlinear, and R for recording unit. The GEDA grew out of a need for simulation equipment on the part of Goodyear Aircraft, the same branch of the tire company that built dirigibles after WWI, and which had begun making missiles following WWII. <http://www.cowardstereoview.com/analog/good.htm>, accessed August 4, 2014.

¹¹⁸ Inertia coupling was merely a theory in 1948, advanced by William H. Phillips in a NACA paper, but it wasn't taken too seriously because his theory dealt with a problem that hadn't occurred yet in any aircraft. The Douglas X-3 was the first NACA aircraft to manifest the problem, on a flight in October 1954 (stressing the aircraft to -6.7/+7g—its maximum). The North American Aviation F-100A, which entered service the previous month, experienced the same problem, causing at least six deaths before being grounded for 3-4 months for modifications. The Air Force wanted to use the new computer to simulate the conditions and try to solve the problem. Email correspondence between Christian Gelzer and Robert Hoey, September 26, 29, 2014; and Phillips, *Effects of Steady Rolling on Longitudinal and Directional Stability*.

¹¹⁹ Waltman, *Black Magic and Gremlins*, p. 8, and email correspondence between Gelzer and Hoey, September 26, 29, 2014.

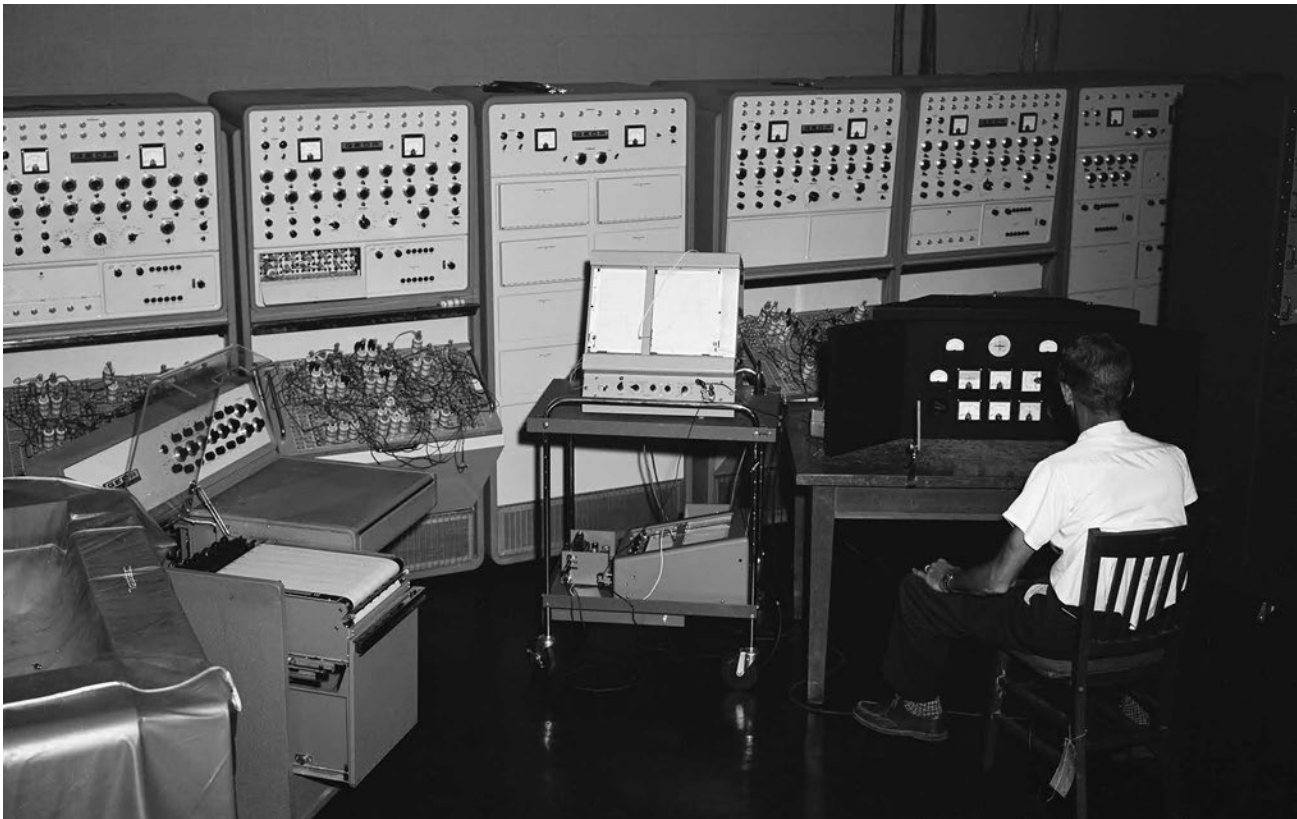

NACA engineer Richard "Dick" Day sitting at the first RCS flight simulator; in front of him is the Air Force's Goodyear Electronic Differential Analyzer that he and others from the HSFS programmed to create the simulation. NASA E56-2626

1955), which was expected to reach 250,000 feet - high enough that standard flight control surfaces would be ineffective because of low q .¹²⁰ Up until this time, the lowest aerodynamic pressure at which any pilot had flown an aircraft was 18.8 psf (.0836 kN/.09 m sq), and while still controllable, the plane was "unsteady."¹²¹ The internationally accepted "standard day," the reference point for aviation metrology, is 2,116 psf and 59 degrees Fahrenheit at sea level (9.4 kN/.09 m sq at 15 C). While researchers were unsure at what altitude and speed aerodynamic controls would no longer be effective, engineers anticipated the need for something else when q reached "on the order of 5-10 pounds per square foot."¹²² At that point, and based on limited past experience, they expected problems with "longitudinal control, high altitude dynamic stability, thrust misalignment, roll coupling, [and] supersonic directional stability."¹²³ Eventually there would be two choices for control in space: changing the angular momentum of a rotating flywheel, and jet forces. With only engineering experience and extrapolation to draw from, those involved with the X-15 program chose jet forces.¹²⁴ (Changing the angular momentum of a rotating flywheel is better suited to items intended for longer durations in space, as it does not use a finite propellant supply.)

Contemporary familiarity with travel and maneuvering in space obscures just how uncertain almost everything was relating to designing and testing the first aircraft/spacecraft destined to carry a human into suborbital flight. Hydrogen peroxide (H_2O_2), for instance - the compound chosen to power the reaction control system on the X-15 - was discovered as a chemical compound in 1818 (referred to initially as "oxygenated water") but was only refined in purity to 60-85% and produced in industrial quantities by the

¹²⁰ The X-15 program was formally launched in 1953 and before its flight program was over the aircraft officially reached 314,750 ft.; it topped that altitude on other flights, ultimately reaching 354,200 ft.

¹²¹ Hubert M. Drake, "Flight Experience with Present Research Airplanes," *Research Airplane Committee Report on Conference on the Progress of the X-15 Project: A Compilation of Papers Presented*, (NACA: October 25-26, 1956), p. 17. The X-2 was at 120,000 feet "pressure altitude" on the flight.

¹²² Wendell H. Stillwell and Hubert M. Drake, *Simulator Studies of Jet Reaction Controls for Use at High Altitudes*, NACA Research Memorandum RM H58G18a, (Hampton, VA: NACA Langley Memorial Aeronautical Laboratory, 1958), p. 2.

¹²³ Drake, "Flight Experience with Present Research Airplanes," p. 15.

¹²⁴ The liquid propellant rocket engine propelled German V-2 (technical name *Aggregat4*, or A4) had exceeded 100 miles in altitude.

German chemical industry starting in the mid-1930s.¹²⁵ It was German engineer and entrepreneur Hellmuth Walter who first used the compound as a monopropellant for assisted takeoffs in aircraft, and who continued to experiment with the compound by adding other chemicals to boost its I_{sp} (specific impulse) while finding ways to use the combinations.¹²⁶ The German rocket program adopted H_2O_2 to power the turbo pumps in the V-2; many of the same team would bring the technology with them to the U.S. after the war and eventually apply it to missiles and rockets.¹²⁷ On contact with a catalyst H_2O_2 sheds the second atom of oxygen. The chemical reaction also produces sufficient heat to turn the remaining molecule into steam. When forced under pressure over a catalyst bed, rapidly decomposing hydrogen peroxide will very quickly exceed 1,000 degrees Fahrenheit (537.8 C). Constrained, this steam can spin turbines which can run pumps or generate electricity, or it can be used simply as thrust.¹²⁸ German advances in refining hydrogen peroxide and developing its applications remained secret until the end of WWII.

In late 1945 Hugh Dryden joined a team set to visit recently uncovered flight research laboratories in Europe to scour them for documents and interview individuals associated with the facilities.¹²⁹ Dryden, then a director at the National Bureau of Standards, led the Navy's Bureau of Ordinance Experimental Unit during the war; Theodore von Kármán, who led the traveling group on behalf of the Army Air Force's Scientific Advisory Group, was director of the Guggenheim Aeronautical Laboratory at the California Institute of Technology (GALCIT), and the Jet Propulsion Laboratory, which was then an Army laboratory. The teams brought back an extraordinary collection of material even while the Army Air Forces gathered up an equally varied collection of German aircraft and rockets they shipped back for testing. It wasn't long before some of the material discovered by Dryden, von Kármán, Hsue-shen Tsien, and others was translated and narrowly disseminated in a report issued by GALCIT in 1946. "The use, by the Germans, of hydrogen peroxide of high concentration has incited general interest in this material as a propellant component," wrote the authors of the classified text. "It has been reported that the Germans were using H_2O_2 of 80% concentration. In this country, the most concentrated hydrogen peroxide generally available is 30-35% by weight in water."¹³⁰

Robert Goddard's work is a useful American benchmark. In 1934, he conceded the need for a pump to force fuel and oxidizer to the combustion chamber of his rockets. Up to then he'd launched his rockets using compressed nitrogen to force gasoline and liquid oxygen to the combustion chamber.¹³¹ This became

¹²⁵ E. Wernimont, M. Ventura, G. Garboden, and P. Mullens, *Past and Present Uses of Rocket Grade Hydrogen Peroxide*, http://www.hydrogen-peroxide.us/history-US-General-Kinetics/H2O2_Conf_1999-Past_Present_Uses_of_Rocket_Grade_Hydrogen_Peroxide.pdf, accessed September 23, 2014.

¹²⁶ I_{sp} or "specific impulse" is the change in momentum for a unit of propellant consumed; it is the definition of how efficiently a rocket engine uses that mass of propellant to generate thrust. The more efficiently a rocket engine uses that unit of propellant to achieve an equal change in momentum, the higher its I_{sp} . Because of variables (propellant choice, temperature, rocket chamber pressure, and nozzle expansion ratio, among other things), I_{sp} is a measure of a propulsion *system*, not just one element. Jonathon Pickrel, email exchange with Christian Gelzer, May 28, 2016, NASA AFRC.

¹²⁷ Walter formed Walterwerke in 1935 to develop hydrogen peroxide as a propulsive compound. By mixing it with other chemicals—hydrazine hydrate, methyl alcohol, or kerosene for example, and achieving a higher I_{sp} —or using it as an oxidizer, Walter produced a 2,200 ft/lb Assisted Take Off motor and a 400 hp submarine motor. E. Wernimont, M. Ventura, G. Garboden and P. Mullens, "Past and Present Uses of Rocket Grade Hydrogen Peroxide," pp. 4-5, http://www.hydrogen-peroxide.us/history-US-General-Kinetics/H2O2_Conf_1999-Past_Present_Uses_of_Rocket_Grade_Hydrogen_Peroxide.pdf, accessed September 23, 2014. See also Noah S. Davis, Jr., and John H. Keefe, "Concentrated Hydrogen Peroxide as a Propellant," *Industrial & Engineering Chemistry*, 1956, 48 (4), pp. 745-748, <http://pubs.acs.org/doi/abs/10.1021/ie50556a025>, accessed September 23, 2014.

¹²⁸ "One pound of [90%] hydrogen peroxide at 32° evolves 1110 Btu of heat [when the process is slow]; when the process is rapid, 60.2 cu ft of gas at 1364° F is liberated, of which 42.6 cu ft is superheated steam and 17.6 cu ft is hot oxygen." *H₂O₂ Field Handling and Storage of 90% Hydrogen Peroxide*, (Denville, NJ: Reaction Motors, Inc., n.d.), p. 3.

¹²⁹ For a list of sites the team visited see *Prophecy Fulfilled: "Toward New Horizons and Its Legacy"*, edited by Michael H. Gorn, (Dayton, OH: Air Force History and Museums Program, 1994). This is an edited version of von Kármán's 1946 Army Air Forces report. Team members recovered some 3,000,000 documents from one site alone, which were microfilmed and sent to the U.S. *Prophecy Fulfilled*, p. 7.

¹³⁰ *A Reference Text Prepared by the Staffs of the Guggenheim Aeronautical Laboratory and the Jet Propulsion Laboratory, GALCIT. California Institute of Technology, for the Air Technical Service Command*, edited by Hsue-shen Tsien, (n.p., 1946), p. 290. Michael H. Gorn, *Hugh L. Dryden: A Career in Aviation and Space*, (Washington, D.C.: NASA, 1996), NASA Monographs in Aerospace History No. 5. See also http://www.liquisearch.com/united_states_air_force_scientific_advisory_board/chronology, accessed October 14, 2016.

¹³¹ Goddard noted that between 1930 and 1932 he used "tanks of compressed nitrogen" to force oxidizer and fuel to the combustion chambers of his rockets. "Liquid-Propellant Rocket Development," (1936) in Robert H. Goddard, *Rockets*, (Reston, VA: American Institute of Aeronautics and Astronautics, 1946, 2002). This is the second of two papers that Goddard submitted to the Smithsonian

problematic for at least two reasons: limited flow rate, and continually dropping flow rate as the nitrogen pressure fell. Goddard built his own piston engine powered “metallic bellows” pumps before discarding them in favor of a de Laval style “centrifugal pump,” but his advance was only superficial: the turbo pump was spun by compressed nitrogen.¹³² There was little change elsewhere in the U.S.: when the Bell X-1 rocket planes arrived for flight testing at Muroc Army Air Field in 1946, the aircraft carried tanks for compressed nitrogen to force the propellant and oxidizer to the combustion chambers.

Excepting the GALCIT report prepared for the Air Technical Service Command in 1946, which would only have been available to select members of industry and the military (the NACA’s relationship with the AAF had not thawed enough to warrant a copy), the first quasi open report on the German development and use of the chemical compound carried a 1947 publication date: NACA TM 1170, *Report on Rocket Power Plants Based On T-Substance*, by Walter.¹³³ That report, which did not physically appear until 1948, was a translation of a paper Walter presented to the German Aviation Research Academy in 1943, and even the translation’s availability was mischievously restricted.¹³⁴ By then the U.S. Army’s nascent ballistic missile program was under way in New Mexico with launches of Corporal missiles and then captured German V-2 rockets (the latter beginning in the spring of 1946), but this knowledge would have been compartmentalized. The GALCIT report edited by Hsue-Shen Tsien indicated that a firm in the U.S. began producing H₂O₂ with 90% purity for “experimental purposes” in 1946 but provided no details.¹³⁵ In 1951 the NACA decided to modify the X-1 it operated (tail number 6063) to include a turbo pump as a replacement for the pressurized nitrogen tank: the pump was driven by decomposed highly concentrated hydrogen peroxide, but the X-1E did not fly again until 1955.¹³⁶

Institution in application for funding. There is no mention of any kind of pump in this paper.

¹³² Robert H. Goddard, *Rocket Development: Liquid-Fuel Rocket Research, 1929-1941*, edited by Esther C. Goddard and G. Edward Pendray, (NY: Prentice-Hall, Inc., 1948), pp. 68-69, 76.

¹³³ Hellmuth Walter, *Report on Rocket Power Plants Based On T-Substance*, translated by Edward S. Schafer, NACA TM No. 1170, (Washington, D.C.: NACA, July 1947). T-Substance was a literal translation of the German *T-Stoffes*, the shorthand for highly concentrated hydrogen peroxide designated for aircraft and missile use. P. R. Stokes, “Hydrogen Peroxide for Power and Propulsion,” read at the Science Museum, London, January 14, 1998, p. 4, http://hydrogen-peroxide.us/history-Germany/hydrogen-peroxide-for-propulsion-and-power_PR_Stokes-1998.pdf, accessed September 24, 2014.

¹³⁴ In the top right corner of the report’s information card was a code instead of a return address—understandable only to the initiate—identifying the branch from which the report emanated. There was no way for an unintended reader to locate another copy—and each copy was numbered, indicating an approved distribution list. Karl Bender, conversation with Christian Gelzer, December 23, 2015.

¹³⁵ *A Reference Text Prepared by the Staffs of the Guggenheim Aeronautical Laboratory and the Jet Propulsion Laboratory, GALCIT*, pp. 288-292.

¹³⁶ Writing about the X-1, R. M. Stanley and R. J. Sansdrom, of Bell Aircraft Corporation, noted: “To supply the propellants to the rocket engine, a turbine driven pump was specified. The development of this item was recognized quite early as being one of the items most likely to interfere with the early flight of the airplane since it involved the development of a highly reliable piece of apparatus of a type hitherto unknown. To forestall probable flight delays a supposedly temporary installation of pressurized tanks was employed.” R. M. Stanley and R. J. Sandstrom, *Air Force Supersonic Research Airplane XS-1 Report No. 1, January 9, 1948*, (n.p., n.d.), <http://history.nasa.gov/x1/afsrax.html#intro>, accessed May 6, 2015; and Memo from Robert M. Stanley to D. Roy Shoultz, Bell Aircraft Corporation, Report of Meeting at Wright Field on March 5-6, 1947. Historian Richard Hallion places the date for the substance of this report sometime in 1945. The difficulty is the reference to H₂O₂ in this scheme which conflicts with information first made available about the chemical from the GALCIT report in 1946. Moreover, Frank Munger, an RMI employee, asserted that he developed the hydrogen peroxide-based turbine independent of the German effort. He further claimed that RMI’s version ran on a 90% solution as opposed to the German 70% solution. This is based on an interview, in contrast to nearly two decades of documented, developmental work by Walter that included extensive tests with additives and practical tests on submarines and aircraft, none of which seem evident in RMI’s claimed independent development, to say nothing of its 90 percent refinement. Winter does not explain how the chemical was refined to that percentage for or by RMI, itself not an inexpensive or easy process—and it would have been the very first in the U.S., something to capitalize on. Frank H. Winter interview of William P. Munger, June 18 1987, in Frank H. Winter, *American’s First Rocket Company: Reaction Motors, Inc.*, (Reston, VA: AIAA, 2017), pp. 109-115. If Stanley and Sansdrom meant a cold gas turbine, à la Goddard, there still would be no significant gain. Walter Dornberger, who came to the U.S. in 1947 via Operation Paperclip and was very familiar with highly concentrated H₂O₂, did not join Bell until 1950. Bell Aircraft planned for the third X-1 to have turbine pumps rather than compressed nitrogen but that airframe was only delivered in 1951 following years of complications and it was lost before research flights began. When North American Aviation tested the Navaho cruise missile engine—a rocket engine—(ca. 1947) the system relied on pressure feed tanks and not turbo pumps. Heppenheimer, *The Space Shuttle Decision*, p. 38.

However, Frank Winter and Fred Ordway argue not only that RMI developed its own turbo pumps independently, but that the U.S. Navy began its own program using high proof hydrogen peroxide in torpedoes in the 1930s. Supposedly, Buffalo Electrochemical Company (BECCO) began supplying highly concentrated hydrogen peroxide around this time and certainly RMI took advantage of the company’s experience in the 1940s. It remains that this account is in conflict with what information GALCIT had at its disposal, including any and all providers of high concentration of hydrogen peroxide. Frank H. Winter and Frederick I. Ordway with James H.

In 1954, the year the engineers at the NACA facility began their research with the Air Force GEDA, Douglas Aircraft, Inc.'s model 671 submission (the company's proposal for what became the X-15), contained a section about "control jets" for use by the aircraft outside the atmosphere. Douglas was explicit about flow rates and tank size and suggested ethylene oxide as a preferred alternative to hydrogen peroxide for several reasons, even while offering either propellant in the proposal. Given that there was no U.S. development of hydrogen peroxide for such use before the end of the war, we can surmise that the Douglas proposal drew on the GALCIT/JPL report, if not the NACA report.¹³⁷ Two years later, at a gathering at Langley of all those directly concerned with the X-15 program, and after North American Aviation (NAA) had been selected as the prime aircraft builder, NAA identified an "attitude control" system for the aircraft to be located in the nose and wing tips, powered by hydrogen peroxide. The company representative offered no details beyond this, however.¹³⁸

In the midst of all this it's important not lose sight of the degree to which the participants were still groping in the dark despite making firm claims for various things. North American Aviation spoke of releasing the X-15 over Salt Lake City, UT for its flight back to Edwards AFB, for example, and the High Speed Flight Station's Hubert "Jake" Drake bluntly said to the audience: "No one airplane has covered the entire range [which the X-15 would explore]; for example, the highest altitude and Mach number points were obtained with the Bell X-2 airplane, but the low-speed point at an altitude of 83,000 feet [25.3 km] was obtained with the Douglas D 558 II airplane. Although the recent loss of the X-2 will prevent the investigation of Mach numbers above 3, the X-1E will be able to reach Mach numbers near 2.8. The actual amount of this possible region that will be explored cannot be determined at present."¹³⁹

This was the context in which the NACA engineers at Edwards AFB began working out a simulation for their pilots to try. They provided a control stick for roll and pitch in the standard manner (using an old "formation stick" from a B-17), while yaw control came from a thumb switch on top of the stick instead of rudder pedals. This setup was not ideal but the pilots soon adapted. A small oscilloscope displayed the simulated pitch and roll to the pilots, while a needle instrument registered the yaw angle.

The initial tests simulated flights of a two-minute duration. At the start of the computer run engineers disturbed the airplane's attitude slightly, requiring the pilot to stop the motion and then hold an attitude of zero yaw, pitch, and roll. The engineers tried two different control methods. The first was "proportional control with a linear variation" based on the degree of stick movement. The second provided half thrust when the stick was first moved, and then full thrust as the control was moved further.¹⁴⁰ Recording the pilots' individual results using the second method, they found the pilots usually fired the RCS system at maximum thrust for brief intervals when making corrections in a flight: in effect, the pilots used the proportional method as an on off system. As a result, and quite possibly because of this, the pilots reported little difference between the two methods and they required only a short time to become familiar with both. The pilots did say that they had to make almost constant, small trim corrections in roll, and wanted roll control to be more powerful than the either yaw or pitch control: they were able to control fairly large disturbances in pitch, and could trim yaw and pitch with only small inputs, but roll response, they felt, was not balanced with the others. The engineers obliged, only to find that increased control effectiveness merely led to over-controlling and a heavier workload.

The engineers also looked at the effect time lag had on control: they were surprised at the results. They'd programed the GEDA so that when a pilot made a control input, the computer simulated an interval of time for the propellant to flow through the pipes, for the thrust to build up, for the aircraft to respond, and for the required attitude change to take place—hysteresis—all of which was realistic (so far as they could calculate at

Wyld, John Shesta and Phillippe Cosyn, *Pioneering American Rocketry: The Reaction Motors, Inc. (RMI) Story, 1941-1982*, (San Diego: AAS, 2015), pp. 222-223.

¹³⁷ Douglas Aircraft Company Technical Report on High Altitude and High Speed, Report Number E.S. 17673, (El Segundo: Douglas Aircraft Co, Inc.), 1954, pp. 41-44. H₂O₂ has a I_{sp} of 161, comparable to ethylene oxide (which ranges between 160 and 190). This is in contrast to a 1957 Bell report which predicted an orbital vehicle would need 14,000 pounds of RCS propellant for a three-orbit mission. "An Approach to Manned Orbital Flight," Bell report D143-945-700, presented to the Committee on Advanced Weapons Technology and Environment of the U.S. Air Force Scientific Advisory Board, July 29-30, 1957, Dennis Jenkins, email to Christian Gelzer, September 18, 2014.

¹³⁸ Charles H. Feltz, "Description of the X-15 Airplane, Performance, and Design Mission," *Research Airplane Committee Report on Conference on the Progress of the X-15 Project: A Compilation of Papers Presented*, (NACA: October 25-26, 1956), pp. 25, 31

¹³⁹ Drake, "Flight Experience with Present Research Airplanes," *Research Airplane Committee Report on Conference on the Progress of the X-15 Project*, p. 15.

¹⁴⁰ Wendell H. Stillwell, "Studies of Reaction Controls" in *Research Airplane Committee Report on Conference on the Progress of the X-15 Project*, (NACA: October 25-26, 1956), pp. 175- 177.

the time). When the pilot stopped firing the thruster there would be another delay as the thrust level decayed to zero and the aircraft settled into its new attitude. Despite all this, the pilots had no difficulty reacting to delays of even one half of one second.

Once the initial simulation tests were complete the engineers added aerodynamic effects of q up to 10 psf (.044 kN/.09 m sq) and ran a second set of tests. At these levels conventional aerodynamic controls were still ineffective but the dynamic pressure had a small effect on the aircraft's behavior. The tests relied on aerodynamic derivatives of the X-1B at Mach 0.5 and the pilot's display was also modified with precise indications of the airplane's pitch and yaw, but the pilots found that control of the simulated aircraft at low q was more difficult than had been so at zero q . If they allowed a sizable yaw angle to develop, the dihedral effect produced rolling moments that the pilot had to use considerable roll control to counter. As the amount of dihedral effect lessened, control of the aircraft became much easier, until there was little difference between 10 psf (.044 kN/.09 m sq) and zero q . The effects of reduced directional stability were less significant than expected, and simulations revealed that the pilots could maintain control even at negative values of directional stability.¹⁴¹

Stanley Butchart, one of the NACA research pilots involved with the simulations, later recalled: "For the early simulations, the biggest problem I had was with the displays. They didn't seem real. It wasn't a true-life thing. It was hard to correlate between real life and looking at a meter. The fellows who rigged them up were the pinball experts who could run them better than we could when we got in and tried to fly 'em."¹⁴² Day, himself a pilot, remembered that "it was hard to get them [pilots] to believe in it." But he was adamant that by repeatedly feeding in new flight data from successive flights the simulations became "a safety device for pilots."¹⁴³

The Iron Cross

The second phase of the RCS research involved building a mechanical ground-based motion simulator, dubbed the Iron Cross, to provide a check for the computer simulations and to more closely approximate the pilot's operating environment.

The Iron Cross was designed and built at the Center late in 1956 and consisted of two steel I-beams, one longer than the other, balanced on a universal joint attached to a supporting strut that lifted it off the ground, and ballasted to the same inertial ratios as the X-1B. The center of gravity was at the pivot point, with the "cockpit" (the pilot's seat) perched on the I beam a similar distance from the center of gravity (cg) as the X-1B's cockpit.¹⁴⁴

The instrumentation on the Iron Cross consisted of a heading indicator, an artificial horizon, and a sideslip indicator. The control stick, a T-handle that articulated up, down, left, right, and twisted clockwise and counter-clockwise, jutted out from the left side of the panel. Thrust for simulator motion came from nitrogen jets mounted in opposing pairs at two locations: one pointing up, one down (pitch), two more pointing right and left (yaw), both on the rear arm of the Iron Cross, and two jets pointing up and down (roll) mounted on the right arm. At the end of each arm was a "crash bar:" a steel strip with a skid at its end, which acted like a spring to prevent damage to either the Iron Cross or the floor of the Calibration Hangar (contemporary Building 4801).

Butchart and other pilots explored basic questions with the Iron Cross, including the design of the special control stick. Years later he remembered: "From the pilot's point of view—the first thing was getting the controls in the right direction. Roll was pretty straightforward; twisting with the wrist, [as was] yaw. When it came to pitch control ... for the nose to go up, I think they [the engineers] had it so that you went down [with] the stick. It soon became obvious to us that the normal way of thinking was to get the nose up you lifted—rather than the logical way, as if you had a normal stick for pitch control. That sort of thing didn't take too long to straighten out."¹⁴⁵

¹⁴¹ Stillwell, "Studies of Reaction Controls," pp. 175-177.

¹⁴² Waltman, *Black Magic and Gremlins*, p. 154. Butchart flew torpedo bombers for the Navy in the Pacific Theater during WWII and was one of the founding members of SETP.

¹⁴³ Richard E. Day, "Cold War Jets Study (A Legacy Resource Management Project) Edwards AFB, Kern County, California, Oral History Transcript, (Edwards, CA: Computer Sciences Corporation, 1995), pp. 11-13. Limited Distribution.

¹⁴⁴ Stillwell, "Studies of Reaction Controls," pp. 176, 177, and Stillwell and Drake, "Simulator Studies of Jet Reaction Controls," pp. 5, 6.

¹⁴⁵ Waltman, *Black Magic and Gremlins*, pp. 153, 154; and Saltzman and Ayers, *Selected Examples of NACA/NASA Supersonic Flight Research*, p. 18



Neil Armstrong at the controls of the Iron Cross. Between the somewhat violent strikes of the I-beams on the hangar floor and motion of the Iron Cross—given the moment arm—the pilots wore seat belts. The controller was mounted horizontally from the instrument panel, as it would be in the X-1B. NASA E56-2607

Eventually engineers and technicians put an aluminum enclosure around the pilot's seat, denying him outside visual cues when "flying," obliging him to work only with the instruments on the panel. The pilot's task during the test runs was to maintain a stabilized attitude while small external disturbances were applied to the Iron Cross. Despite its ungainly, even comical appearance, the Iron Cross revealed control problems that were too subtle for the analog simulator to manifest, such as how important it was to align the thrust axes of the reaction controls - that "perfectly trimmed flight would be difficult to maintain manually, and it was very easy to over control."¹⁴⁶



The final configuration of the Iron Cross, showing the full enclosure for the pilot and the bottles of compressed nitrogen for thrust. E58-3669.

¹⁴⁶ Stillwell and Drake, "Simulator Studies of Jet Reaction Controls for Use at High Altitudes," pp. 13, 14.

X-1B

The aircraft already selected to carry the first RCS tests was the Bell X-1B. This second generation design used the same wing, horizontal tail, and XLR11 rocket engine as the first-generation X-1 but had a fuselage just over 4.5 feet (1.37 m) longer than the original design - the maximum length that could fit in the bomb bay of a B-29 launch aircraft. A more significant change was the airplane's calculated maximum performance, which increased to Mach 2.47 at 70,000 feet (21.336 km). Work on the X-1B RCS installation began in February 1957. Not part of the original design, the RCS had to be shoehorned into the aircraft.

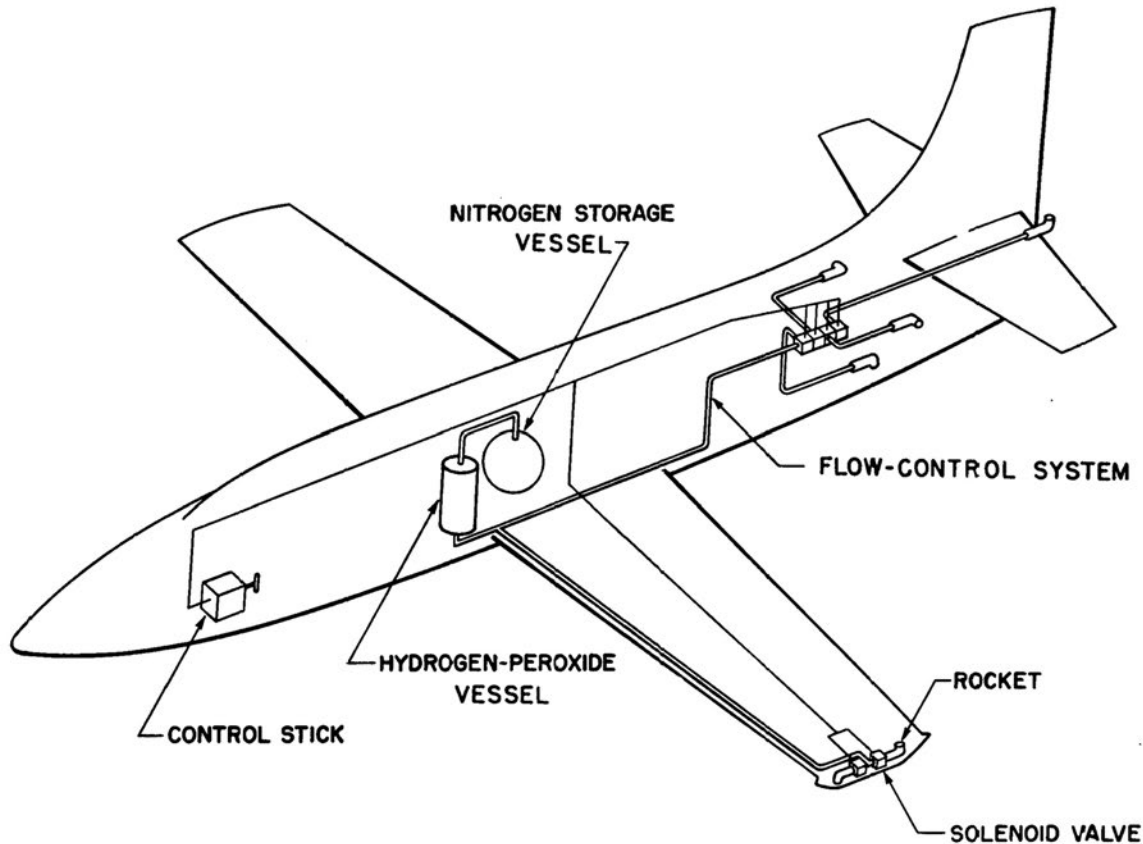

A line drawing showing the layout of the RCS in the Bell X-1B. NASA TN D-185

Due to the X-1B's internal design the placement of the thrusters was unusual, but reminiscent of the Iron Cross, arranged to provide "the largest possible moment arm."¹⁴⁷ The single pair of roll thrusters was mounted in the left wingtip. The yaw thrusters were in the rear fuselage, placed ahead of the tail. The pitch thrusters' location was the most unusual. One thruster was in the underside of the fuselage, pointing down: placed aft of the cg, it caused the nose to pitch down. The other pitch thruster was at the extreme aft end of the fuselage, just above the engine nozzles and behind the rudder, and caused the aircraft to pitch up when fired.

The thrusters had different energy levels, reflecting their distance from the aircraft's cg. A separate control stick, mounted horizontally on the left side of the instrument panel (based on the Iron Cross experience), was used to fire the thrusters. Firing the thrusters was an on/off selection. When the pilot moved the stick, microswitches connected to solenoid valves operated for each thruster; when a valve opened, a solution of 90% hydrogen peroxide was forced over silver-coated stainless-steel screens. The hydrogen peroxide decomposed into 700 degree Fahrenheit (371 C) steam which expanded out the thruster nozzle. Hydrogen peroxide had the advantage of being a monopropellant and typically non-toxic; its disadvantage was that it decomposed in contact with organic materials and was highly corrosive.¹⁴⁸

¹⁴⁷ James E. Love and Wendell H. Stillwell, *The Hydrogen-Peroxide Rocket Reaction-Control System for the X-1B Research Airplane* NASA TN D-185, (Edwards, CA: NASA Flight Research Center, 1959), p. 5.

¹⁴⁸ Love and Stillwell, "The Hydrogen-Peroxide Rocket Reaction-Control System for the X-1B Research Airplane," 5. The larger advantage of H_2O_2 was its non-toxic nature compared to typical rocket propellants such as dimethyl hydrazine or red fuming nitric

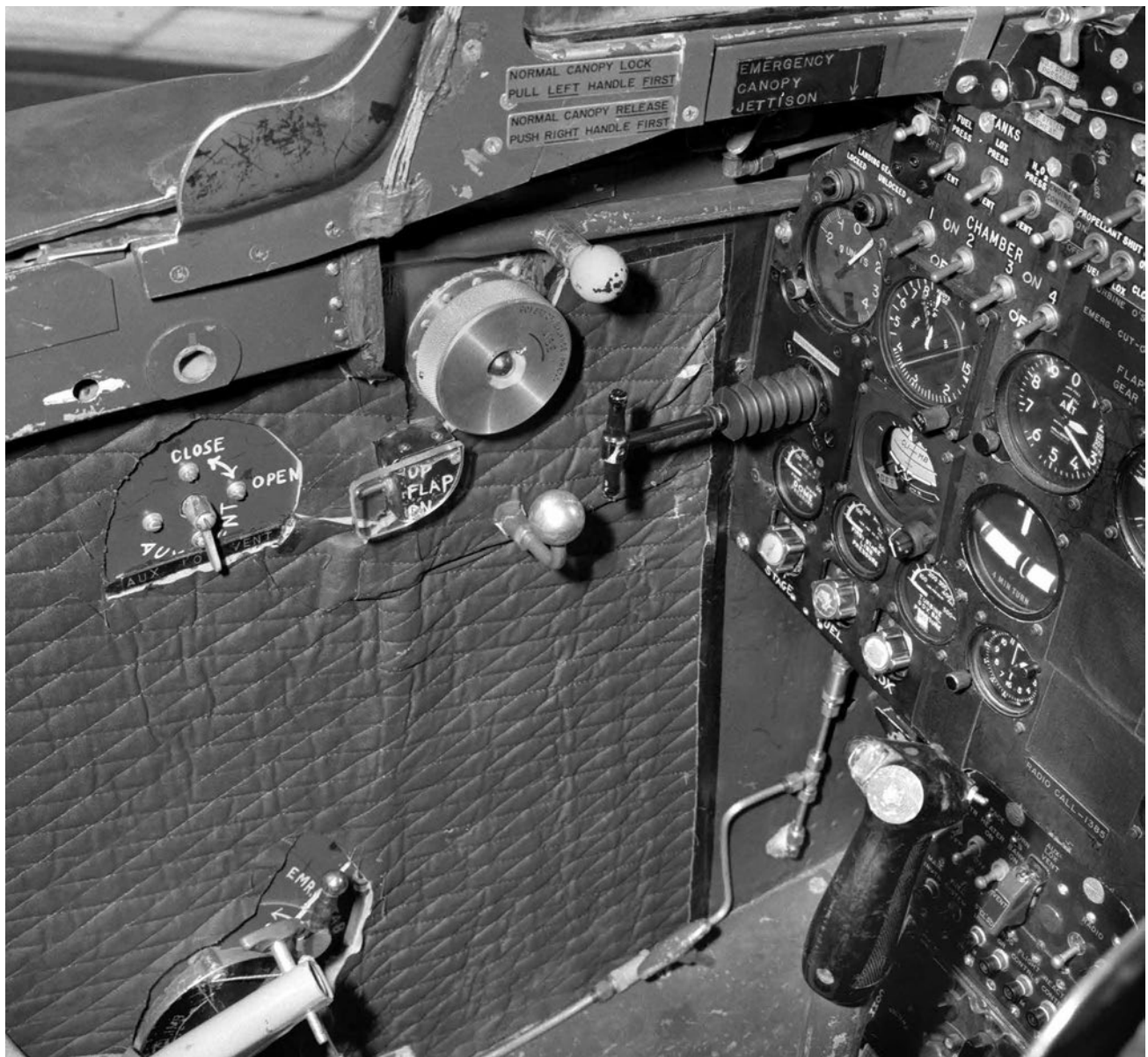

The now modified cockpit of the X-1B, with the RCS controller sticking out of the left side of the instrument panel. The plumbing can be seen coming down from beneath the instrument panel and running along the left side of the cockpit. NASA E58-3941

In February of 1957 work began on instrumenting the X-1B for the RCS research flights; by the end of March the installations and the high-altitude instruments were about 70% complete.¹⁴⁹ By the end of April two ground runs of the four-chamber XLR11 rocket engine had been made; the only things missing were the thruster nozzles themselves, which were being manufactured by Bell.¹⁵⁰ In July 1957 Neil A. Armstrong joined Butchart as pilot on the X-1B research project. Armstrong transferred to the High-Speed Flight Station from the NACA's Lewis Research Center in 1955, and over the next two years flew a range of aircraft at the HSFS. He had been flying an F-51 chase plane when the X-1A exploded, had been the co-pilot on the P2B-1S launch aircraft when a propeller on the number 4 engine came apart at the hub (one blade passed through the number 3 engine nacelle, the acid. The concentrated compound was regularly used over the years at the Center either as a thruster propellant or to spin turbines via steam, thus generating electricity for an aircraft.

¹⁴⁹ Because H_2O_2 freezes at 18 degrees Fahrenheit and the X-1B experienced temperatures of -40 to -100 degrees Fahrenheit between takeoff and flight while in the B-29, engineers and technicians insulated the 2.4-gallon tank and arranged to heat it electrically during flight to ensure the compound did not freeze. Love and Stillwell, "The Hydrogen-Peroxide Rocket Reaction-Control System for the X-1B Research Airplane," pp. 3-4.

¹⁵⁰ X-1B Progress Reports, February 1 to February 28, 1957; March 1 to March 31, 1957, and April 1 to April 30, 1957, File L1-3-11A-1, NASA Armstrong Historical Reference Collection.

fuselage, and the number 2 engine nacelle), but he did not yet have any rocket plane experience.¹⁵¹

Armstrong made his first X-1B pilot familiarization and checkout flight on August 15, 1957, during which the number 2 rocket chamber failed to light after the aircraft was released from the B-29. Despite this problem, he reached a speed of Mach 1.32 on the remaining three chambers. The approach and flare to the lakebed landing were normal, but the X-1B touched down nose wheel first; skipped into the air and the nose wheel sheared off. The resulting slide across the surface of the lakebed damaged the underside of the fuselage and LOX tank. Such landing problems were not uncommon with the X-1 aircraft; the damage took six weeks to repair.¹⁵²



Posed for this image is everyone and (almost) everything necessary for a flight of the X-2. It succinctly illustrates one reason why a shift to a production aircraft (the F-104) as a replacement for an experimental rocket plane (the X-1B) was desirable even if the former was less capable. NASA E-5743

¹⁵¹ Christian Gelzer, "The D-558-II," presented at the Experimental Aircraft Association's *AirVenture*, Oshkosh, July 30, 2003. Passing through the fuselage the blade missed Jack McKay in the D-558-II, who, just moments earlier had been released from the shackles to make his own way back to the base. P2B-1S was the Navy designation for the Boeing B-29.

¹⁵² Neil Armstrong pilot report, Flight 14, August 15, 1957, File L1-3-11A-3, and X-1B Progress Reports, August 1 to August 31, 1957, File L1-3-11A-1, NASA Armstrong Historical Reference Collection. The X-1 series aircraft had poor elevator authority at low speeds, and pilots often found pitch control on landing suddenly inadequate; the aircraft would then touch down awkwardly, overstressing the nose gear strut, resulting in its failure. It did not help that the only suspension came in the form of balloon tires that tended to cause the

The X-1B log for Friday, October 4, 1957 read: “A/C [aircraft] Down. Wiring is about complete. Work is at temporary slow down awaiting reaction control wingtips.”¹⁵³ That evening, while most of the Center’s pilots were down in Los Angeles at the first gathering of the Society of Experimental Test Pilots, the world changed when the Soviet Union launched Sputnik.

X-1B RCS Research Flights

As the post-Sputnik controversy swirled, preparations continued for the RCS flights.¹⁵⁴ The first flight to test the system came on November 27 with a new pilot to the program: John B. “Jack” McKay. He’d served with the Navy as a pilot in the Pacific Theater during WWII and went on to make 30 flights in the X-15 for the NACA/NASA. McKay made the RCS test at Mach 1 and 60,000 feet (18.28 km) but the RCS operated poorly.¹⁵⁵ A ground run of the system on December 10 went badly and by the time the engineers and technicians fixed the problems, rain had closed Rogers Dry Lake.¹⁵⁶ By January 6, 1958 everything was ready for the second RCS checkout flight.¹⁵⁷ But it was ten days before the flight actually took place, with Armstrong as the pilot.¹⁵⁸

After the drop, Armstrong lit the rocket engines and began a climb from 26,500 feet (8.077 km), firing each of the six RCS thrusters in turn for one second. He then flew a relatively low-altitude/low Mach number combination, shut down two of the engine chambers and a third soon after, made a complete set of RCS firings, and came in for a landing, again firing all RCS thrusters on the way in for a successful mission.¹⁵⁹

The next flight of the X-1B RCS was scheduled for May 28, but a pre flight inspection found four cracks in the bottom of the LOX tank. These were welded closed and the areas X-rayed, but analysis revealed persistent internal cracks.¹⁶⁰ On June 30 the Center permanently grounded the aircraft.¹⁶¹ Despite its potential, the principal limitation of the X-1B was its experimental nature—it was a rocket plane, a singular aircraft with unusual requirements for flight and prone to issues that frequently grounded it. Its value was its ability to reach altitudes high enough to demonstrate the value of RCS, but clearly its problems steeply curtailed its usefulness.

The JF-104 RCS Research Aircraft

Following the grounding of the X-1B in June 1958, Station chief Walt Williams met with his staff regarding airplane to rebound.

¹⁵³ X-1B Log Book, File L1-3-11A-2, and X-1B Progress Reports, September 1 to September 30, 1957, File L1 3 11A 1, NASA Armstrong Historical Reference Collection.

¹⁵⁴ X-1B Log Book, NASA Armstrong Historical Reference Collection. There are no entries between that of October 8, 1957, which states that the work was still in progress, and the November 8 entry about the ground test.

Early in his research Hellmuth Walter experimented with H₂O₂ jets on a Heinkel He 72 Kadett. “In January, 1937, the first flight of a DVL aircraft with T-substance auxiliary propulsion took place at Alimbsmühle in the presence of Colonel Udet, who piloted the third flight. In June 1937, the first T-substance rockets were fired. Then in rapid succession take-off auxiliary, main propulsion, and other rocket drives were brought out in experimental versions.” What he didn’t say explicitly in the first sentence is as important as what he said explicitly in the second and third sentences: the first sentence describes testing something other than assisted takeoff or main rocket propulsion. British researcher P. R. Stokes is certain this refers to “a scientific investigation into the early use as wing ‘bonkers’ in imposing a roll moment for aerodynamic stability study.” If so, and it is hard to disagree with Stokes’ conclusion, this would be the first attempt at a reaction control system—and a hydrogen peroxide based one no less. It ended after three flights, and while no German rocket adopted the system, it would have been suitable for atmospheric flight at low speeds or high angles of attack. P. R. Stokes, “Hydrogen Peroxide for Power and Propulsion,” read at the Science Museum, London, January 14, 1998, p. 4, http://hydrogen-peroxide.us/history-Germany/hydrogen-peroxide-for-propulsion-and-power_PR_Stokes-1998.pdf, accessed September 24, 2014, and Christian Gelzer interview with Albion Bowers, NASA AFRC, September 24, 2014, regarding the viability of such an RCS in atmospheric flight.

¹⁵⁵ X-1B Progress Reports, November 1 to November 30, 1957, File L1-3-11A-1, NASA Armstrong Historical Reference Collection.

¹⁵⁶ The rocket planes, and many of the other experimental aircraft in the period, operated on and off of the immense lakebed that was one of the *raison d’être* of Edwards Air Force Base: miles and miles of possible runways in almost any direction. Still, seasonal rains often flooded portions of the lakebed and softened the rest, suspending such operations until the lakebed could dry out sufficiently.

¹⁵⁷ X-1B Log Book, File L1-3-11A-2, NASA Armstrong Historical Reference Collection.

¹⁵⁸ Daily Diary 1958, File L3-10-1A-2, NASA Armstrong Historical Reference Collection.

¹⁵⁹ Neil Armstrong Flight Report, X-1B flight 16, January 16, 1958, File L1-3-11A-3, NASA Armstrong Historical Reference Collection.

¹⁶⁰ Daily Diary 1958 and X-1B Progress Reports, January 1, 1958 to January 31, 1958, X-1B Log Book, X-1B Progress Report, May 1 to May 31, 1958. File L1-3-11A-1, NASA Armstrong Historical Reference Collection. This was not the first time that cracks in the LOX tank were repaired. A memo dated January 6, 1956 states: “Cracks in LOX tank rewelded.” [sic] X-1B Progress Reports, June 1 to June 30 1959. File L1-3-11A-1, NASA Armstrong Historical Reference Collection. The same problem contributed to the retirement of the X-1E (6063) in 1959. Walter C. Williams, correspondence to NASA Headquarters, re: termination of programs on the X-1E, May 6, 1959; and Walter C. Williams, correspondence to R. H. Frost, Vice President, Stanley Aviation Corp., June 4, 1959. AFRC Historical Reference Collection.

¹⁶¹ Memorandum from Stanley R. Schaub to chief of the HSFS, June 30, 1958.

the unfinished RCS program. At the meeting were Hubert “Jake” Drake, Kenny Klienknecht, Joe Vensel, and Jim Adkins, among others. Williams made it clear, Adkins later recalled, that “we had to have this reaction control program that he had promised and someone had better come up with a way to get the job done.” During the meeting Adkins remarked to Drake that he thought they could do the RCS tests using a Lockheed F-104. After the meeting, Drake cornered Adkins and told him to “prove it.” Adkins, who described himself as “just one of many young and foolish engineers with imagination,” set to work.¹⁶²

He gave his briefing three weeks later; it lasted several hours, obliging the attendees to skip lunch. When he’d finished, Williams asked him when he could start, how long it would take, how much it would cost, how many people would be needed, and who they were. In response to the answers, Williams provided \$60,000 in startup money along with help from Keith Anderson and Wendell Stillwell, who had done early RCS modeling work on the GEDA. Adkins could also call on engineers Jim Love and Perry Row.¹⁶³ Within weeks he’d assembled a team of 16 to 18 engineers, technicians, and shop personnel.

The first F-104 delivered to the NACA, a pre-production aircraft (serial number 55 2961), was now modified for the RCS program and designated a JF-104. Joseph A. “Joe” Walker was named the project pilot.¹⁶⁴ Walker flew P-38s for the Army Air Corps in North Africa during WWII and joined the NACA after the war. He was an accomplished rocket plane pilot by this time and would become the first NASA pilot to fly the X-15.

The JF-104 offered notable advantages to the X-1B. The rocket plane required extensive preparations before flight, not to mention a separate launch platform; the JF-104, on the other hand, was an operational aircraft capable of multiple flights a day as well as launching itself.¹⁶⁵ All of the modifications were made “in-house” rather than through a contractor. Richard Day built the JF-104 RCS analog simulator cockpit from a plywood box. The simulator was to determine the aircraft’s performance characteristics at low dynamic pressures, and to define a task for Walker to perform using the RCS.

Reflecting everything learned to date, the JF-104 RCS was a more mature design than that in the X-1B. For one thing, no plumbing with hydrogen peroxide ran through the aircraft, helping prevent damage to the aircraft from leaks of the corrosive propellant. The JF-104’s hydrogen peroxide tanks and tubing were also in close proximity to the thrusters, further reducing potential problems. The four pitch and yaw thrusters were mounted in the nose cone, along with their spherical hydrogen peroxide tank. The roll thrusters in one wing were co-located with another hydrogen peroxide tank. In both cases the locations of the thrusters and tanks matched those planned for the X-15, as did the tanks themselves.¹⁶⁶

Walker made the first RCS flight on July 31, 1959, taking the JF-104 to 30,000 feet (9.144 km) and Mach 0.8: q measured 280 psf (1.245 kN/09 m sq). When he pressurized the RCS, the roll thruster screens ruptured and the hydrogen peroxide jettisoned, leaving only the pitch and yaw thrusters. Still, he found that the aircraft responded as predicted to the firing of those thrusters that were functioning.¹⁶⁷ He flew with the active RCS on September 16, and again on September 21.¹⁶⁸ On September 25 Armstrong flew the aircraft to test the RCS system: the flight log notes read: “surprising ride: Neil recommends it.”¹⁶⁹

On October 2, 1959 Walker took off for the first actual zoom flight, wearing an Air Force partial pressure suit because of the intended altitude necessary to achieve the low q .¹⁷⁰ Flying west before turning back toward

¹⁶² Letter from Jim Adkins to Betty Love, (n.d.), Love private collection.

¹⁶³ Letter from Adkins to Love.

¹⁶⁴ In U.S. Air Force nomenclature the prefix “J” denotes an aircraft that has been temporarily modified for test purposes.

¹⁶⁵ The JF-104 was, nevertheless, a pre-production aircraft, prey to landing gear door, engine, afterburner, and drogue chute problems, and on at least one flight the cabin depressurized during a turn at some 20,000 feet. It took a long series of flights to sort out the problems before the aircraft flew reliably. JF-104A Flight Logs 1-169, 1956-1961, File L1-3-10B-1, NASA Armstrong Historical Reference Collection.

¹⁶⁶ Donald Reisert and Elmor J. Adkins, “Flight and Operational Experience with Pilot-Operated Reaction Controls,” American Rocket Society (March 13-16, 1961), pp. 4-7, and Joseph A. Walker, “Investigation of Aircraft Control by use of Reaction of Small Rocket Motors,” *Society of Experimental Test Pilots Newsletter* (November 1960), pp. 7-9.

¹⁶⁷ J. A. Walker, “Pilot’s Flight Report F-104, No. 961, Subject: Initial flight and ground evaluation and operation of reaction control installation,” (n. d.), F-104 Notebook, File L1-3-10B-1, NASA Armstrong Historical Reference Collection.

¹⁶⁸ Chart: F-104 #961 Reaction Control Airplane, F-104 Notebook; and Reisert, JF-104 #961 notebook, File L1-3-10B-3, NASA Armstrong Historical Reference Collection.

¹⁶⁹ September 25, 1961, JF-104A Flight Logs 1-169, 1956-1961, File L1-3-10B-1, NASA Armstrong Historical Reference Collection.

¹⁷⁰ This was a precursor to the three Air Force NF-104s, aircraft specifically modified for zoom climbs and intended as trainers for the exo-atmospheric portion of flight in the X-15 and Dyna-Soar (X-20). Compared to a stock F-104, the NF-104s had extended wings, RCS, and a Rocketdyne AR2-3 rocket engine (6,000 pounds of thrust) added above and just behind the jet exhaust nozzle. Typically starting the maneuver at 35,000 feet, pilots accelerated to Mach 1.92 and began the zoom climb. In the JF-104 the climb ended when

Edwards he made a 3 g pull up at Mach 1.92 when he was closer to the base than planned, as he later put it, “in the interests of getting the maneuver before leaving the Rogers Lake area.” Holding a steady 4-degree angle of attack during the climb, he began using the RCS before the aircraft reached peak altitude and found “they performed admirably.” In fact, he used the RCS to control his angle of attack (AoA) during much of the ascent, both to maintain his AoA and to correct divergences.¹⁷¹ He reached 78,000 feet (23.77 km) and Mach 1.18. Q at peak altitude was 62.5 psf (.278 kN/.09 m sq). He remarked later: “this program has at last reached a stage where operational prosecution of the research program can be carried on successfully.” (On exiting the aircraft Adkins handed Walker a large certificate that read, in part, “Ut Intesta Fortitudo Sin’que Intelegencia.”)¹⁷²

He went on to make a series of RCS flights in the JF-104 between March and August 1960, after which several other X-15 pilots made flights in the aircraft.¹⁷³ Although these flights continued into 1961, the RCS research was coming to a close: the aircraft was now being used for pilot familiarization, X-15 weather checks, and dead stick landing practice. The goals of both the X-1B and JF-104 RCS projects were limited and short term. Once pilots and ground crews had learned what they needed to know, the experiment had served its purpose.¹⁷⁴ By the time the JF-104 flights were drawing to a close, the X-15 was beginning its early research flights.¹⁷⁵ On that aircraft/spacecraft RCS was integral, used for control when dynamic pressure was too low for aerodynamic surfaces to affect the aircraft’s trajectory. The MH-96 adaptive flight computer on X-15-3 integrated the RCS with aerodynamic control surfaces so that the pilot did not have to switch back and forth between control methods: he simply flew the aircraft and the computer determined which system to use depending on the conditions.¹⁷⁶

The relationship between the data collected from the JF-104 RCS flights and the final design of the X-15 RCS is clear: eight yaw and pitch thrusters were located on the nose of the X 15 while two roll thrusters were positioned near *each* wing tip (double that of the JF-104 for redundancy). Because a failure of the RCS at high altitude could lead to the loss of the X-15, the thrusters were divided into two separate, redundant systems.

Within a few days of NASA’s establishment, on October 1, 1958, Administrator T. Keith Glennan gave his approval to develop Project Mercury. Like the X-15, the thrusters aboard the Mercury capsule used 90% hydrogen peroxide and the design of the thrusters was virtually the same as those on the X-15.¹⁷⁷ The capsule’s eighteen thrusters came in three sets of six (for redundancy), with different maximum thrust levels – the 6-pound (.0267 kN) thrusters, the 24 pound (.107 kN) “high-torque” thrusters, and the 1-pound (.0044 kN) “low torque” thrusters for fine attitude control.¹⁷⁸

The Lunar Landing Research Vehicle

As early as 1960 engineers at the Flight Research Center proposed to NASA Headquarters that the Center the aircraft reached an altitude at which oxygen levels were too low to sustain combustion and the jet engine died; not long after this the aircraft exhausted its inertia and descended. The NF-104 pilots did the same but then fired the rocket engine when the jet died, continuing to climb until its fuel was spent, often cresting above 110,000 feet, where q was very low indeed and the RCS was critical. In spite of its intended purpose, the NF-104 was ultimately used by the Air Force’s Test Pilot School (Aerospace Research Pilot School at the time) as a teaching and research tool and not as a trainer for the X-15 or the X 20 (which was never built). The “N” prefix in Air Force nomenclature denotes a permanent modification to an aircraft.

¹⁷¹ Pilot’s Flight Notes, F-104 #961, January 29, 1960, Chart: F-104 #961 Reaction Control Airplane, File L1 3 10B 2, NASA Armstrong Historical Reference Collection.

¹⁷² The “standard day” parameters, the internationally accepted reference point for aviation metrology, is 59 degrees Fahrenheit and 2,116 psf at sea level, contrasted with Walker’s 62.5 psf q at 78,000 feet. Pilot’s Flight Notes, F-104 #961, January 29, 1960, Chart: F-104 #961 Reaction Control Airplane. File L1-3-10B-2, NASA Armstrong Historical Reference Collection. Loosely translated: “More guts than good sense.”

¹⁷³ The X-15 began flying in 1959, and although to that point it was only being flown by North American Aviation pilot A. Scott Crossfield during the acceptance flights, the program’s first group of pilots had already been selected.

¹⁷⁴ Roy Bryant, phone interview with Curtis Peebles, March 16, 2004.

¹⁷⁵ The first X-15 research flight came on March 25, 1960, with Joe Walker at the controls; it was the ninth flight of the X-15. (The previous eight flights came with Scott Crossfield at the controls performing acceptance flights.) Richard P. Hallion and Michael H. Gorn, *On the Frontier: Experimental Flight at NASA Dryden*, (Washington, D.C., Smithsonian Institute, 2003), p. 407.

¹⁷⁶ *Experience with the X-15 Adaptive Flight Control System*, and Calvin R. Jarvis and Wilton P. Lock, *Operational Experience with the X-15 Reaction Control and Reaction Augmentation Systems*, NASA TN D-2864, (Edwards, CA, NASA Flight Research Center, 1965).

¹⁷⁷ The choice of H₂O₂ directly reflected the work done at the High Speed Flight Station as well as the early state of affairs. Loyd S. Swenson, Jr., James Grimwood, and Charles C. Alexander, *This New Ocean: A History of Project Mercury*, (Washington, D.C.: NASA SP 4201, 1998), p. 195.

¹⁷⁸ *Results of The First United States Manned Orbital Space Flight*, February 20, 1962, pp. 11, 12, <http://www.hq.nasa.gov/office/pao/History/SP-6/ch1.htm>, accessed July 21, 2013.

conduct research on “pilot control during entry into the lunar gravitational field and subsequent vehicle recovery or landing.”¹⁷⁹ In 1961, following President Kennedy’s speech to Congress challenging the nation to go to the moon, Bell Aircraft Corporation submitted a proposal to build a free-flying simulator to train the astronauts for landing on the moon. Neither Bell nor the Center knew of the other’s work but their solutions looked remarkably alike. NASA accepted Bell’s proposal and in late 1964 the company delivered two Lunar Landing Research Vehicles (LLRVs) to the Center for assembly, as they would be flown at the Center to validate the still uncertain concept while establishing the ideal settings of thrust and flight parameters for the astronauts to fly.

The LLRV was a six-degrees-of-freedom simulator meant to take off vertically, fly a lunar descent profile, and land, doing so while mimicking a lunar gravitational field 1/6 that of the Earth’s, and the absence of any environment, which is to say, no wind. This order was a tall order to fill at the time. The General Electric CF700 fan jet engine chosen to lift the LLRV off the ground and keep it and the pilot in the air for the roughly 8-minute simulation was not yet commercially available. The thrust-to-weight ratio when lifting the LLRV, the pilot, and a complement of fuels was 1.05:1, providing the slimmest of margins.¹⁸⁰ Because of this (the weight), Bell could not use mechanical controls, and so built an analog computer fly-by-wire control system for the LLRV, making it the first pure fly-by-wire (FBW) aircraft to fly. Everything the pilot commanded went to the computers that, in turn, commanded the same from the fanjet or the thrusters.¹⁸¹ The fly-by-wire solution echoed the realities of spacecraft and matched the Apollo program’s own FBW Command Module and Lunar Module (LM) control systems, although those were digital computers.

Because the LM would be using thrusters for attitude, roll, pitch, and translation, the LLRV designers turned to the same method of control that the engineers at the Center had been employing since 1956: hydrogen peroxide thrusters.¹⁸² There were eight 500-pound (2.446 kN) thrusters arranged around the frame of the LLRV set to fire downward to control descent; at the four corners there were clusters of three thrusters providing pitch, yaw, roll, and translation control on the vertical axis.¹⁸³ Bell received a contract to build three Lunar Landing Training Vehicles based on the tests and modifications done at the Center. These and one of the modified LLRVs were sent to the Manned Spacecraft Center for astronaut training.

Conclusion

A continuous thread runs from the analog computer simulations originated by the NACA engineers and pilots using the Air Force’s GEDA, through the Iron Cross, the X-1B, JF-104, X-15, to the Mercury spacecraft. The thread extends to the Lunar Landing Research Vehicle, the Lunar Landing Training Vehicle, the Gemini and Apollo spacecraft, to the space shuttle orbiter, to Manned Maneuvering Units, and includes any vehicle in space that relies on thrusters for maneuvering or repositioning. Beyond the technological work those at the Center undertook was the first genuine human engineering assessment of how best to operate a control system outside Earth’s atmosphere.

In 1970 Neil A. Armstrong provided perhaps the greatest testament of RCS’s value when he recounted landing on the moon to members of a review panel at the Manned Spacecraft Center. Noting that in the final stages of descent he found the LM headed for a landing in a field of large boulders, he maneuvered the LM across the moon’s surface to a different site. “I will admit that in my approach you’ll see a lot more attitude changes and throttle changes than you would like to see. Still, I felt very comfortable—I felt at home. I felt like I was flying something I was used to, and it was doing the things that it ought to be doing.”¹⁸⁴ He was crediting his experience in the free-flying LLRV and LLTV, but the larger point is this: he was able to maneuver the LM to safety because it had the RCS. The RCS is the punctuation to the conceptual work that Day, Reisert, Weil, Stillwell, and others at the NACA began with the GEDA in 1954 - work that transferred directly to the space shuttle orbiter.

¹⁷⁹ Gene J. Matranga, C. Wayne Ottinger, Calvin R. Jarvis, with D. Christian Gelzer, *Unconventional, Contrary, and Ugly: The Lunar Landing Research Vehicle*, (Washington, D.C. NASA, 2004), p. v.

¹⁸⁰ Matranga, Ottinger, Jarvis, and Gelzer, *Unconventional, Contrary, and Ugly*, p. 131.

¹⁸¹ Matranga, Ottinger, Jarvis, and Gelzer, *Unconventional, Contrary, and Ugly*. Each computer controlled one axis in flight.

¹⁸² One of the early options the FRC engineers looked at and rejected was a Navy experiment at China Lake, California, where engineers there were testing a tethered, remotely controlled landing system powered by red fuming nitric acid and dimethyl hydrazine. Hydrogen peroxide was not the propellant of the LM RCS because of its lower I_{sp} compared to other options.

¹⁸³ Matranga, Ottinger, Jarvis, and Gelzer, *Unconventional, Contrary, and Ugly*. The LLRV’s thrusters used a solution of 90% hydrogen peroxide.

¹⁸⁴ Neil A. Armstrong, NASA MSC Minutes of Meeting of Flight Readiness Review Board, Lunar Landing Training Vehicle, Houston, TX, January 12, 1970.

5: Lifting Bodies and Low L/D Research

Peter W. Merlin

JT3

Edwards Air Force Base

Abstract:

Engineers at the NASA Ames Research Center offered the lifting body as an alternative to capsules as a return system from space. These wingless, low lift-to-drag vehicles allow astronauts to fly to a chosen destination and land at an airport. Despite their potential, issues associated with these vehicles lead to the shuttle's adoption.

Keywords:

John Manke; Mike Love; Energy management; Lifting bodies; NASA Ames Research Center; Dale Reed; NASA Johnson Space Center



NASA engineer Wen Painter drew this illustration during the lifting body program to highlight the merits of using a lifting body instead of a capsule. The illustration was picked up by one of the professional trade magazines at the time. Image courtesy of Wen Painter NASA E66-1321

John Manke's bulky pressure suit made the interior of the small wingless craft seem cramped as he worked through his prelaunch checklist. The X-24B lifting body – its narrow delta shape and flat belly earning it the nickname “flying flatiron” – hung beneath the wing of a modified B-52 then cruising at an altitude of 45,000 feet (13.7 km) over California's Mojave Desert. When the countdown reached zero, the X-24B dropped away. Seconds later, Manke ignited the vehicle's four-chamber XLR11 rocket engine and climbed to a peak altitude of 60,000 feet (18.288 km). As the craft nosed over and the engine shut off, he scanned the desert below looking for a narrow gray strip of concrete near the edge of Rogers Dry Lake, on Edwards Air Force Base.

It was August 5, 1975, and this was Manke's last lifting body flight. In the previous seven years he had flown 41 research flights in the HL-10, X-24A, M2-F3, and X-24B, each a lifting body and each a unique shape with its own peculiar handling characteristics; all were rocket-powered, requiring air launch from the NASA Center's NB-52B carrier aircraft and landing without power.¹⁸⁵ Because lifting bodies have very low lift-to-drag ratios (some pilots felt it was akin to flying a brick), all landings had been made on the 44 square-mile expanse of Rogers Dry Lake where there was a significant margin for error.¹⁸⁶ Today's flight would be different. For the first time a pilot would touch down in a lifting body on a paved runway, in this case the base's 15,000-foot-long, 300-foot-wide (4.57 km by .091 km) concrete runway. In addition, Manke was aiming to make a precise touchdown at a white stripe of paint marking roughly the first mile from the runway threshold - a target sometimes used by pilots from the Air Force Test Pilot School.

Seven minutes after dropping from the launch aircraft, Manke had the X-24B lined up for final approach.¹⁸⁷ Moments after lowering the landing gear he touched down precisely on target, “the left wheel just ahead of the white line and the right wheel down just beyond the white line.”¹⁸⁸ The demonstration showed a group of invited engineers that a low L/D (lift-to-drag ratio) vehicle could approach from high altitude or low Earth orbit and land like a conventional airplane at a specific, designated, and fairly confined location. “We now know,” he later said, “that concrete runway landings are operationally feasible and that touchdown accuracies of plus or minus 500 feet [152.4 m] can be expected.”¹⁸⁹

If getting into space is a matter of brute force, returning to Earth is an exercise in finesse. Roger Launius and Dennis Jenkins point out that long after humans began planning for spaceflight, “in the 20th century the dominant vision of how to achieve this was via orbital spaceplanes. Those early space flight engineers envisioned the spaceplane flying into orbit, undertaking its missions, and returning to land on Earth like airplanes at an airport.”¹⁹⁰ “German experimenters,” notes Ray Williamson, were the first to consider reusable launch vehicles (RLVs) in a serious way.¹⁹¹ Examples include engineer and rocket enthusiast Walter Hohmann's *The Attainability of Heavenly Bodies* in 1925 - a carefully argued treatise on exiting and entering the Earth's atmosphere. He assumed that on return the spacecraft would have wings and employ one of several deceleration methods so as not to burn up on entry, culminating in what amounted to controlled flight to a landing.¹⁹²

Likely the best known of these concepts was Eugen Sänger's *Silbervogel*, which he conceived while a doctoral student in Vienna and publicly revealed in 1933.¹⁹³ But Andrew Butrica reminds us that in 1931

¹⁸⁵ Edwin J. Saltzman, K. Charles Wang, and Kenneth W. Iliff, *Flight-Determined Subsonic Lift and Drag Characteristics of Seven Lifting-Body and Wing-Body Reentry Vehicle Configurations with Truncated Bases*, Presented as AIAA 99-0383 at the 37th AIAA Aerospace Sciences Meeting and Exhibit, Reno, Nevada, January 11-14, 1999, p. 20.

¹⁸⁶ The X-24B had the best lift-to-drag ratio (L/D) of all the lifting bodies, at 4.5:1, topped only slightly by the space shuttle orbiter's 4.7:1, itself actually a winged spacecraft. Reed with Lister, *Wingless Flight*, p. 175.

¹⁸⁷ This translates into a descent rate of roughly 8,500 ft/min.

¹⁸⁸ Johnny Armstrong, “X-24B Concrete Runway Landing,” in *Flight Testing at Edwards*, <http://www.johnnyarmstrong.com/test-stories/x-24b-concrete-runway-landing/>, accessed April 22, 2014.

¹⁸⁹ John A. Manke and Michael V. Love, “X-24B Flight Test Program,” *SETP Technical Review*, Society of Experimental Test Pilots, Lancaster, CA, Vol. 12, No. 4, September 1975, pp. 129-154.

¹⁹⁰ Roger D. Launius and Dennis R. Jenkins, *Coming Home: Reentry and Recovery from Space*, (Washington, D.C.: NASA, 2011), p. 8.

¹⁹¹ Ray A. Williamson, “Developing the Space Shuttle,” in *Exploring the Unknown: Selected Documents in the History of the U.S. Civil Space Program, Volume IV: Accessing Space*, edited by John M. Logsdon, (Washington, D.C.: NASA, 1999), p. 161.

¹⁹² Walter Hohmann, *The Attainability of Heavenly Bodies*, NASA TT F-44 (Washington, D.C.: NASA, 1960), original publisher: Munich: R. Oldenbourg, 1925. Hohmann's calculations for the optimum transfer trajectories for objects travelling to other planets were sufficiently accurate that they are now referred to as the Hohmann Transfer.

¹⁹³ Eugen M. Sänger, *Rocket Flight Engineering*, NASA TT F-223, (Washington, D.C.: NASA, 1965). (A translation of Sänger's 1933 publication *Raketentflugtechnik* containing extensive descriptions of a winged rocket and its trajectories, along with multiple illustrations.)



The X-24B makes a steep descent over Rogers Dry Lake on its approach to the main runway at Edwards AFB. It is accompanied by two chase planes NASA E75-4907

Robert Goddard imagined a craft with wings, powered by a combination air-breathing engine and rocket to reach space and return to a landing on Earth.¹⁹⁴ These plans are not surprising inasmuch as those who look to the future draw on the present and the past for inspiration and airplanes were an especially potent technology in the 20th century.

With the advent of rockets that reached space (the German A4 was the first), in 1946 the Army Air Forces commissioned a study of orbital satellites by the RAND Corporation (with a three-week deadline). A portion of the study considered the feasibility of a spacecraft for re-entry. “An important ultimate goal for any vehicle must be that of carrying human beings [to space and back] with safety,” wrote Harold Luskin in the chapter on returning home. “One obstacle which seems to stand in the way is the great energy stored in the vehicle, a part of which serves to heat the vehicle on descending in the lower atmosphere. Landing introduces a preliminary problem of dissipating the tremendous heat stored in the vehicle by virtue of its speed.”¹⁹⁵ Dissipating the spacecraft’s energy was, Luskin noted, a matter of controlling its trajectory on entry, and thus

¹⁹⁴ Andrew J. Butrica, “Reusable Launch Vehicles or Expendable Launch Vehicles? A Perennial Debate,” in Steven J. Dick and Roger D. Launius, eds., *Critical Issues in the History of Spaceflight*, (Washington, D.C.: NASA, 2006), pp. 303-304, citing Goddard, “A New Turbine Rocket Plane for the Upper Atmosphere,” in *Popular Science*, December 1931 issue, pp. 148-149. File 824, NASA Historical Reference Collection, NASA Headquarters, Washington, D.C.

¹⁹⁵ H[arold]. Luskin, “The Problem of Descent and Landing,” *Preliminary Design of an Experimental World Circling Spaceship*, Report No. SM-11827, (Santa Monica, CA: RAND Corporation, Douglas Aircraft Company, 1946), p. 192. https://www.rand.org/pubs/special_memoranda/SM11827.html, accessed January 11, 2018. Luskin is named among the patent holders of the Douglas X-3.

the heat it generated and absorbed while passing through the atmosphere. “Wings of small size shall be used for speed control during descent and for landing. Poor values of lift to drag ratio are not, for that reason, out of order here.”¹⁹⁶ Notwithstanding the report’s enthusiasm for a spaceplane with wings, this, like all the other “fly back from space to a landing” plans remained mostly fancy for want of an understanding of hypersonic flight and the upper atmosphere. Both would become better understood in the 1950s.¹⁹⁷

The shift to ballistic and near-ballistic entry into the atmosphere, similar to that of a missile warhead, was a function of the Cold War, costs, and the demand for quicker results than research into maneuvering re-entry flight allowed. Following Sputnik’s launch “it became obvious that a ballistic capsule was both the best and quickest way to get Americans into orbit; the available launch vehicles simply could not support the increased weight of a winged vehicle.”¹⁹⁸ The early missions to space by the Soviets and Americans all used capsules for re-entry. This method resulted in high g-loads and intense heating due to atmospheric friction during re-entry. Ground-test subjects in a centrifuge demonstrated that humans tolerated extended periods of high g-loads better when force was applied from front to back, the so-called “eyeballs-in” mode. Hence, Mercury (the only U.S. manned spacecraft to use a strictly ballistic entry trajectory) was designed so the single crewmember lay on his back facing away from the direction of flight during re-entry. Final deceleration was accomplished with a parachute, the capsule landing in the ocean.¹⁹⁹ (Despite the commitment to the capsule and ballistic method, one member of the Panel for Manned Space Flight urged his colleagues to consider a flying vehicle as the re-entry solution in the future.²⁰⁰)

During the Gemini and Apollo programs a semi-ballistic trajectory provided a small amount of lift (aerodynamic force perpendicular to the flight path) during entry, allowing increased cross-range and more accurate guidance to the recovery point, as well as decreased g loads and temperatures.²⁰¹ Aft-facing, semi-reclined crew position and parachute recovery were still necessary, leading some designers to pursue a configuration known as a lifting body that could be flown much like a conventional airplane to a controlled landing on a runway.

The defining characteristic of such an aircraft-spacecraft was a fully lifting entry into Earth’s atmosphere during which the pilot could adjust the flight path continuously, changing both altitude and flight direction while decelerating from orbital velocity (Mach 25) to a safe landing speed. The configuration minimized heating and maximized potential cross-range while reducing g-loading, allowing the pilot to sit facing forward as in a conventional airplane. The favored lifting entry configurations were delta-winged craft such as the X-20 Dyna-Soar and wingless lifting bodies.²⁰²

The concept of the lifting body stemmed from work done by H. Julian Allen and Alfred Eggers in the very early 1950s, both of whom worked at the NACA Ames Aeronautical Laboratory (later renamed the NASA Ames Research Center). Their experiments with a half cone shape for an atmospheric entry vehicle emerged from their work on re-entry problems of missile-launched warheads for the U.S. Ballistic Missile Agency.

“Body shapes of interest for high-speed missiles would more probably be with nose shapes having nearly hemispherical tips,” they wrote. “It is well known that for any truly blunt body, the bow shock wave is detached and there exists a stagnation point at the nose. The bow shock wave is normal to the stagnation streamline and converts the supersonic flow ahead of the shock to a low subsonic speed flow at high static

¹⁹⁶ Luskin, “The Problem of Descent and Landing,” p. 198. Luskin would eventually work for NASA’s Space Task Group.

¹⁹⁷ The first hypersonic wind tunnel was planned in Germany but not realized because of the exigencies of WWII. John Becker led the way in building the first hypersonic research tunnel at Langley: it opened in 1947.

¹⁹⁸ Launius and Jenkins, *Coming Home*, p. 44. Georges Méliès’ *Voyage dans la Lune* (1902), offered an alternative way home; his explorers travel to and from the moon in a bullet-shaped craft which splashes into the ocean nose first on return to Earth.

¹⁹⁹ Robert Hoey, “Testing Lifting Bodies at Edwards,” *Air Force/NASA Lifting Body Legacy History Project*, pp. 1-9, PAT Projects, Inc., 1994. “Eyeballs-in” refers to the direction the eyeballs would move in response to the force applied. Deceleration in a capsule while lying on your back has this effect.

²⁰⁰ “Dr. Eggers ... stressed that the panel should consider a lifting vehicle in planning for future spaceflight projects.” Minutes of Meetings, Panel for Manned Space Flight, September 24, 30, and October 1958, in John M. Logsdon and Roger D. Launius, eds., *Exploring the Unknown: Selected Documents in the U.S. Civil Space Program. Volume VII Human Spaceflight: Projects Mercury, Gemini, and Apollo*, (Washington, D.C.: NASA, 2008), pp. 86-88.

²⁰¹ Gemini had an L/D of “about 0.3. Mercury had a hypersonic L/D of 0.” Apollo’s L/D was 0.6. Albion Bowers, email correspondence with Christian Gelzer regarding lift-to-drag (L/D) nomenclature in aeronautical literature. NASA DFRC, December 13, 2011. “Dryden’s Contributions to the Shuttle Program Notes.” NASA AFRC Historical Reference Collection.

²⁰² Hoey, “Testing Lifting Bodies at Edwards,” “Dyna-Soar” was a contraction of “Dynamic Soaring.” Also proposed was the North American X-15B delta wing, which was never built.

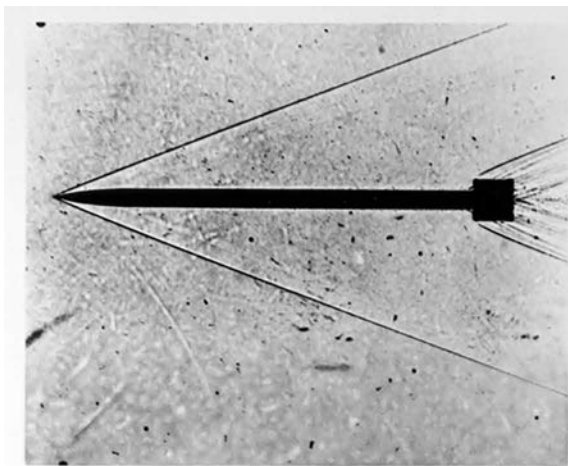

INITIAL CONCEPT

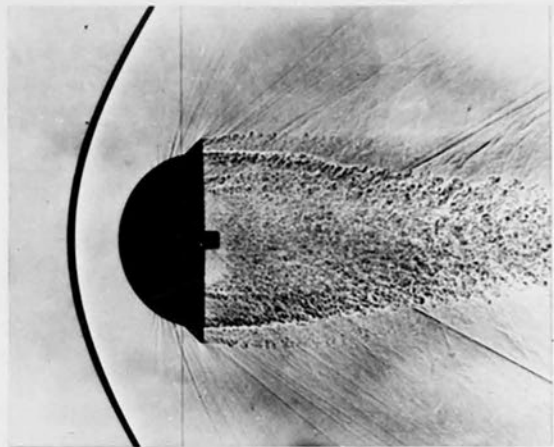

BLUNT BODY CONCEPT 1953

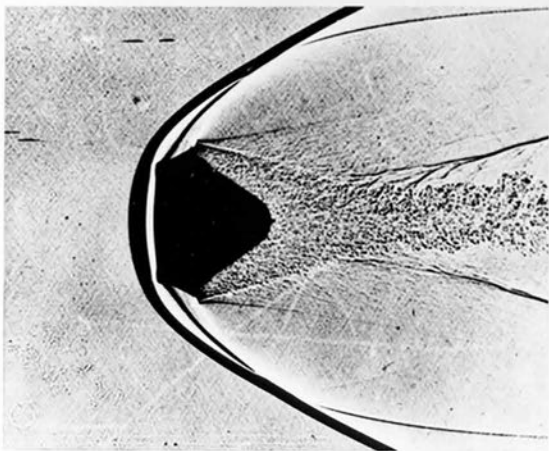

MISSILE NOSE CONES 1953-1957

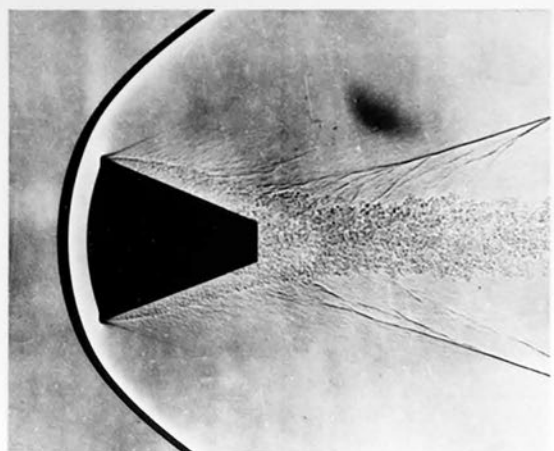

MANNED CAPSULE CONCEPT 1957

Schlieren images from wind-tunnel work at Ames show the shockwave attached to the cone but as a detached bow wave on the blunt shape. Kinetic and potential energy thus became heat that, crucially, was transferred to the atmosphere rather than being absorbed. NASA Ames

temperature downstream of the shock.” The two authors followed this with another study focused specifically on long-range hypersonic vehicles rather than missiles, in which they considered hypersonic glide vehicles designed to carry pilots.²⁰³ In some of their studies their warhead models were mounted at a small angle relative to the airflow in the wind tunnel; from this they discovered that the cone they were testing actually generated a small amount of lift. With the blunt end of a cone entering the atmosphere first, the researchers found the shape produced a strong detached bow shock, and that shock wave provided thermal protection. But it also had an extremely low L/D (less than 1) and experienced 8 g entry loads - greater than comfortably acceptable for a human crew. Still, their work on hypersonics paved the way for subsequent re-entry flights with humans aboard.

Allen, Eggers, and colleagues Clarence “Sy” Syvertson, George Edwards, and George Kenyon designed a blunt half-cone configuration for a piloted orbital vehicle with a much more acceptable L/D ratio of around 1.5(:1), resulting in a 1 g-acceleration load and a cross-range of more than 1,500 miles (2,414 km) from the initial point of atmospheric entry.²⁰⁴

²⁰³ H. Julian Allen and A. J. Eggers, *A Study of the Motion and Aerodynamic Heating of Ballistic Missiles Entering the Earth's Atmosphere at High Supersonic Speeds*, NACA Report 1381, (Ames Aeronautical Laboratory Field, Moffett Field, Calif., April 1953), p. 7, and Alfred J. Eggers, Jr., H. Julian Allen, and Stanford E. Neice, “A Comparative Analysis of the Performance of Long-Range Hypervelocity Vehicles,” Report 1382, in *NACA 44th Annual Report of the National Advisory Committee for Aeronautics 1958 Report*, (Washington, D.C., 1958), pp. 1141-1160.

²⁰⁴ In the ratio of lift-drag (L/D) lift is always expressed first. That said, references in aeronautical literature to L/D and hypersonic

In 1958 the NACA Ames Aeronautical Laboratory held a Conference on High-Speed Aerodynamics meant to “convey to the military services and their contractors the results of recent research and to provide those attending an opportunity to discuss the results.” The meeting drew engineers and some pilots from virtually every NACA Center as well as representatives from the military and industry, and the registered attendees for the two-day meeting (given the topic, access would have been restricted) numbered at least 480.²⁰⁵ Among the papers presented was one by four Ames researchers which projected the following for the lifting body: “The vehicle is assumed to be in a circular orbit at an altitude of 100 miles [160.9 km], and it was assumed that sufficient reserve thrust was used to bring the vehicle down to an altitude at which aerodynamic drag becomes significant (70 miles [112.65 km]): the total range is about 20,000 miles [32,186.8 km].” There was even as much as a 230-mile (370.15 km) range for lateral deviation in this calculation.²⁰⁶ Their proposal was for a “high-lift high-drag configuration” which they felt had “attractive possibilities for a satellite vehicle.”²⁰⁷ Langley’s John Becker, on the other hand, argued for a low L/D spacecraft, concluding that a high L/D extended atmospheric flight to little profit in the case of re-entry; a high L/D vehicle would incur unnecessary aerodynamic heating, as well. Still, his, like theirs, was a winged craft, not a pure lifting body.²⁰⁸ Launius and Jenkins write in *Coming Home* that even while Becker and others at Langley were proponents of the X-15, a winged spaceplane intended “to fly back from near space to normal runway landings, the X-15 ultimately used a variation of Allen’s blunt body theory.”²⁰⁹

By 1960, the Ames team had refined one lifting body configuration to a 13-degree half cone with a blunted nose and a hypersonic L/D of 1.4(:1). Inadequate subsonic stability necessitated tapering the aft end and adding vertical stabilizer fins. The team designated this configuration “M2.” At this point, R. Dale Reed, an engineer at the Flight Research Center, took the initiative to make the theory real. Along the way he became the most visible and perhaps most vocal champion of lifting bodies. The M2 served as the basis for hand tossed models he built on his own time, a series of subscale radio-controlled models he flew, and eventually a lightweight piloted glider, followed by a family of heavyweight rocket-powered vehicles.

While a capsule could carry a human into space, it completed its journey back to Earth suspended from a parachute; the lifting body would allow a pilot to fly home and land on a runway. There were several advantages to this beyond reduction in g forces, including lowering costs by eliminating the expense of an ocean splashdown and recovery (typically involving a small Navy flotilla). “The lifting body ‘footprint’ for

re-entry vehicles sometimes entail certain assumptions, to wit: drag is always 1 (unity) and can therefore be dispensed with, meaning references to L/D can—without notice—be done shorthand; that L/D changes as a spacecraft transitions through the three speed regimes (hypersonic, supersonic, and subsonic); and that references to said vehicle’s L/D usually reflect the most critical phase of flight, its approach and landing, typically Mach .25 or so. Elements of this are found in the references made by Syverston, Edwards, and Kenyon to their half-cone re-entry shape with an L/D of “1.4” to “1.5”. They also appear in AFRC engineering references to the X-15’s L/D of 4 and the M2-F1’s L/D of 2.8. Allen and Eggers presented their findings, supplemented by the work of Dean Chapman, also of Ames, at the NACA Conference on High-Speed Aerodynamics, held at the NACA Ames Aeronautical Research Center in 1958. See also Saltzman, Wang, and Iliff, *Flight-Determined Subsonic Lift and Drag Characteristics of Seven Lifting-Body and Wing-Body Reentry Vehicle Configurations*, p. 20. Peter Merlin, conversation with Johnny Armstrong, December 13, 2011, Edwards AFB; and Albion Bowers and Nalin Ratnayake, email correspondence with Christian Gelzer regarding lift-to-drag nomenclature in aeronautical literature, December 12-13, 2011, and January 26-27, 2012. “Dryden’s Contributions to the Shuttle Program Notes.” NASA AFRC Historical Reference Collection.

²⁰⁵ Introduction, *NACA Conference on High-Speed Aerodynamics, A Compilation of Papers Presented*, Ames Aeronautical Laboratory, Moffett Field, Calif., March 18, 19, and 20, 1958, (Moffett Field, CA: NACA, 1958), p. vii. Among the attendees were: Ira Abbott, Smith DeFrance, Walter Diehl, Hugh Dryden, Max Faget, Robert Gilruth, Robert T. Jones, Alexander Kartveli, Ezra Kotcher, Randolph Lovelace, Clark Millikan, Abe Silverstein, Hartley Soulé, and Walter Vincenti. Firms from industry included Aerojet-General Corp., Applied Physics, Corp. Bell Aircraft Co., Bendix Corp., Boeing Airplane Co., Chance Vought Aircraft, Inc., Convair, Douglas Aircraft Co., General Electric Co., General Motors, Corp., Glenn L. Martin Co., Goodyear Aircraft Corp., Hughes Aircraft Co., Lear, Inc., Link Aviation Inc., Lockheed Aircraft Co., Marquardt Aircraft Co., McDonnell Aircraft, Minneapolis Honeywell Regulators, North American Aviation, Inc., Northrop Aircraft Co., Pratt & Whitney Aircraft Div., Ramo Woolridge Corp., RAND Corp., Reaction Motors, Inc., Republic Aviation Cop., Sandia Corp., Sperry Gyroscope Co., Tempco, United Aircraft Corp., and Westinghouse Electric Corp.. Virtually every branch of the military was represented, as were their research centers; so too, were more than half a dozen universities.

²⁰⁶ Thomas J. Wong, Charles A. Hermach, John O. Reller, Jr., and Bruce E. Tinling, “Preliminary Studies of Manned Satellites, Wingless Configuration: Lifting Bodies,” *NACA Conference on High-Speed Aerodynamics*, pp. 38, 40.

²⁰⁷ Wong, Hermach, Reller, and Tinling, “Preliminary Studies of Manned Satellites, Wingless Configuration: Lifting Bodies,” p. 39.

²⁰⁸ John V. Becker, “Preliminary Studies of Manned Satellites: Winged Configurations.” *NACA Conference on High-Speed Aerodynamics*, pp. 45-58.

²⁰⁹ Launius and Jenkins, *Coming Home*, p. 8.

a hypersonic vehicle—that is, one with a speed of Mach 5 or greater and a lift-to-drag ratio of 1.5—includes the entire western United States as well as a major portion of Mexico.”²¹⁰ The term “lifting body,” coined by Allen and Eggers following their early work, referred to a spacecraft that “could safely re-enter Earth’s atmosphere, gain aerodynamic control and land like an airplane . . . because the lift came from the fuselage rather than wings, which were too vulnerable to melting during re-entry.”²¹¹

Reed came across the lifting body work of Allen and Eggers and he was the first to move the concept from wind tunnel model to full-scale test aircraft. He started with homebuilt models, tossing them from the roof of his house while his wife, Donna, filmed their descent with an 8mm movie camera. He moved on to models he built and tossed down the halls at the Center, to the bemusement of his colleagues, all the while proselytizing about the concept’s potential.



Milton O “Milt” Thompson standing next to the M2-F1, the world’s first full-scale lifting body, which he was the first to fly. NASA EC62-206

In 1962, Reed spoke with researchers at Ames and Langley about his work and heard only skepticism that such a design could be built without some sort of deployable wings or pop out engines to enable a safe landing. He was undeterred: experiments with scale M2 models gave him confidence that a full-scale, piloted craft could be safely flown and he soon enlisted other engineers at the Center in his cause. Together with selected engineers (and a pilot) he approached Center Director Paul Bikle with a proposal for a full-scale, piloted, glider version of the M2 that would be towed aloft behind an airplane. It did not hurt that Milton O. “Milt” Thompson, who offered to fly the experiment, was by then an experienced research pilot at the Center and a member of the first group of X-15 pilots, or that Bikle was himself a sailplane pilot and flight test engineer with an adventurous spirit.²¹²

²¹⁰ Reed and Lister, *Wingless Flight*, p. 10.

²¹¹ Glenn E. Bugos, *Atmosphere of Freedom: Sixty Years at the NASA Ames Research Center*, (Washington, D.C: NASA, 2000), p. 81.

²¹² Reed and Lister, *Wingless Flight*, 8-17, 1997. Bikle concluded a long career with the Air Force as Technical Director of the

Thompson flew the X-15 fourteen times between 1963 and 1965 and was integral in convincing Bikle to approve plans for a full scale, flyable “wind tunnel model” lifting body, so called to obscure the project because it did not have approval from NASA HQ. Bikle assumed that no one would pay much attention to a wind tunnel model when it appeared on any financial sheet: if this wind tunnel model could actually fly with a pilot in it, that would be a happy accident.

The M2-F1 (manned rated #2, flight vehicle #1) was built behind a curtain in the fabrication shop (on the curtain coyly hung a sign reading “Wright Bicycle Shop”).²¹³ Gus Briegleb, an established sailplane builder from El Mirage Dry Lake, not far from the base, was contracted to build the wooden fuselage. When complete and ground tested with car tows (using a highly modified 1963 Pontiac Catalina two-door convertible), the first full-scale lifting body was towed into the air by the Center’s R4D in August 1963 and released directly over the base’s largest dry lakebed. Its glide path to Rogers Dry Lake was steep and its flight brief, but the success of the flight was reason to celebrate, for the team showed that the idea itself worked.²¹⁴

Energy management, which lay at the heart of the lifting body concept, was not new to those who worked at the Center. Starting in 1946, the Bell X-1 rocket planes were carried aloft in the belly of a B-29 and released for flight; once the fuel was spent the bullet shaped aircraft became a glider. Just as relevant were the unpowered launches from the carrier aircraft that inculcated the method. Not an especially good glider, the X-1 was able to fly without power because of the kinetic and potential energy it accrued in the form of speed and altitude which the pilot traded to land safely on the dry lakebed at Edwards AFB (then still Muroc Army Air Field). The same applied to the rocket-powered D-558-2, the X-2, and the X-15 - the marked difference being the distance the pilot had to fly under energy management to reach to the dry lakebed. In order to complete a Mach 3 flight (the intended top speed of the X-2), that aircraft had to be released far from the base; gone were the days in which a rocket plane could make its entire run over or near the base’s 44-square mile (114 km sq) dry lakebed. By the time the X-15 began its project flights, in 1960, the distance flown under energy management was the width of a state and more.

A typical flight for the X-15 meant launching over eastern Nevada. If everything went according to plan, the pilot lit the motor shortly after falling away from the NB-52B carrier aircraft and began a fast, steady climb.

Directorate of Flight Test at Edwards AFB, before he assumed the position of Center Director of the NASA Flight Research Center at the Base, in 1959. He set the world altitude record for a sailplane on February 25, 1961, reaching 46,269 during a flight near the Base in his Schweizer 1-23E. (A Bristol 138A high-altitude research aircraft set the world altitude record for powered flight in September 1936 at 49,967 ft.)

²¹³ For the acronym’s explanation see Reed and Lister, *Wingless Flight*, p. 19. Among Briegleb’s gliders are the BG 6, the BG-7, and the BG-12.

²¹⁴ Reed and Lister, *Wingless Flight*, pp. 12, 16-17, 21, 52. Sage minds decided that they ought to tow the M2-F1 across the lakebed to find out how it performed before taking the wingless vehicle to altitude. Walter “Whitey” Whiteside remembers: “[Center director Paul] Bikle came to me and said: ‘Whitey, we need a tow car to tow the lifting bodies.’ I had followed the races enough that I knew where all the shops were. I’d had cars of my own that went fast and motorcycles that went fast, so I broke loose and just took off and went all over southern California looking for what can [sic] we put the most horsepower to the ground so that it can tow something out on the lakebed here: it turned out that the Mexican road race for the last three years had been won by a Pontiac. And I knew Troy Rutman and all the guys that were involved with this kind of a thing - the ones that won it, because I was interested in such a thing.

I made the rounds and I ended up in the Motorday building down here in North Hollywood with the Pontiac West Coast management staff. I said: ‘this is not for publication, but the government wants to buy a tow vehicle of the caliber that you’ve been letting your ‘out stations’ build and publicize. We can’t publicize this. We want to buy a car and build a car and we don’t want to spend a whole lot of money.’

I went around to all the speed shops and I found out what tires will withstand 180 miles an hour and what wheels. We bought a whole bunch of wheels and tires so that you could change the Pontiac to go 150 miles an hour or 130 miles an hour. We only bought three or four sets [so that] in 30 minutes you could make the Pontiac tow something 100 miles an hour or 150 miles an hour. I took it and had roll bars put in it so people could go with me. I talked to Troy Rutman and I explained what we were doing: ‘We’re going to tow things out in the boonies and the engine’s going to get tired. How soon is it going to get tired?’ He said: ‘You know we only run them on Sunday, and then we take them apart and put them together again.’ I said: ‘We can’t afford that. What can I do horsepower-wise, tire-wise, brake-wise, cooling-wise, transmission-wise - what can I do to make this thing start up the biggest part of the time without spending a lot of bucks on it? We can’t publicize it.’ So, he gave me a whole lot of points and I followed through on them. And that’s how come I had two sets of tires, and so forth. But when the Pontiac got tired after we made a certain amount of runs with it just like he told me it would--I arranged the car to go 165 miles an hour--and when it got tired, why I pulled the engine out and sent it in and had it done by them. And they brought it right back up to snuff.” Walter W. Whiteside, Interview with Dill Hunley, July 30, 1997, AFRC Historical Reference Collection.

To avoid potential legal problems related to purchasing a Pontiac Catalina convertible with Center funds they referred to the Pontiac on paper as the “lifting body power plant.” Bertha M. Ryan, interviewed by Sandra Johnson and Rebecca Wright, June 13, 2001, NASA Johnson Space Center Oral History Project.

Usually he shut the engine down after 90 seconds, rarely letting it run more than two minutes, at which point the propellant and oxidizer tanks were virtually empty anyway. The X-15 carried so much energy by then that it continued its ascent, sometimes into space, before reaching its apogee and beginning its descent. The X-15 was back on the dry lakebed at Edwards usually in 9-10 minutes—a figure that included the 90-120 second



For years leading up to the shuttle's final plan very nearly every design—including those from industry—presumed the orbiter would have some form air-breathing turbine engines with which to fly in the atmosphere. This ignored all the experience engineers and pilots at Dryden had developed since 1947 in the form of energy management, a lesson the engineers were hard pressed to convince the rest of the agency to take seriously. EC72-3520

engine burn as well as the time spent at “high key” completing a 360-degree circle starting at some 35,000 feet (10.668 km) above the base while setting up for a landing. X-15 pilots used energy management for nearly 4/5 of each flight and always landed without motive thrust: relying on energy management for control of the M2-F1 was hardly new to those at the Center, and certainly not to Milt Thompson.

The success of the M2-F1 led to a family of heavy lifting bodies, starting with the M2-F2 which, unlike its wooden predecessor, was made of aluminum, had retractable landing gear, and had to be air dropped from the NB-52B. The M2-F2 was followed by the M2-F3, really the M2-F2 rebuilt and modified after a horrific landing accident and now sporting a third vertical stabilizer and carrying an XLR11 rocket motor for propulsive thrust after release from the carrier aircraft. Two other lifting bodies had already joined the research project: the HL-10 and the X-24A; the latter was rebuilt into the X-24B, something not preceded by an accident.²¹⁵ No matter which lifting body one examines, each relied on the principle of energy management.²¹⁶

²¹⁵ The M2-F2 had especially bad flight characteristics, including a roll rate of 270 degrees per second. NASA pilot Bruce Petersen crashed while landing, on May 10, 1967, sending him to the hospital. Petersen recovered and the Center decided to rebuild the M2-F2 with modifications, renaming the vehicle the M2-F3, which had vastly better flying qualities. The HL-10 (Horizontal Lander design #10) was a Langley design.

²¹⁶ Martin Marietta refined the A3 shape (designed by Fred Raymes of the Aerospace Corporation) and delivered the SV-5 series for the Air Force Flight Dynamics Laboratory. The SV-5P (piloted) was subsequently re-designated the X-24A by the Air Force. The Hollywood release *Marooned* (1969) based on Martin Caidin's novel of the same name, featured an SV-5/X-24A, dubbed the X-RV, as

By 1974 the space shuttle was well into the design phase and the program's engineers had already selected a winged vehicle instead of a lifting body for the reusable spacecraft. Although successful as a concept and a flight vehicle, a lifting body was impractical for the orbiter in part because of the required cargo bay (15 feet by 60 feet) (4.57 m by 18.29 m): accommodating this volume in a lifting body would have resulted in something whose size and deadweight would negate any gains offered by that type of vehicle. How to make a viable, reusable thermal protection system for the type also eluded researchers at the time. The shuttle designers eschewed the planform altogether, but in the process, seemed to ignore the High Desert center's decades of experience with energy management, as well as other lessons derived from the lifting body program.²¹⁷

Throughout much of the planning stage the shuttle engineers wrestled with what to do once the orbiter was back in the atmosphere: should it strictly be a glider or should it have some source of propulsion to enable flight to both a planned or an emergency landing site? Former X-15 pilot Joe Engle, who flew some of the Approach and Landing Tests in the prototype space shuttle orbiter Enterprise and eventually flew to space in the X-15 (three times) and shuttles Columbia and Discovery, described the consensus of the period: "Initially, the concept was to put air-breathing engines on the orbiter."²¹⁸ With the thirty-year experience of the shuttle in the mirror the idea might seem odd, but air-breathing engines on a reusable space vehicle was a feature common to many of the early design concepts for the orbiter, as well as to early notions of reusable spacecraft dating to the 1960s. Typically the engines were stowed inside the orbiter, to be deployed once far enough into the Earth's atmosphere that they could operate. But the enduring plan surprised more than a few at the Center given the decades of successful energy management technique with rocket planes, including the spacebound X-15, not to mention the low L/D lifting body program.²¹⁹

In 1970, the Flight Research Center held a symposium for parties interested in lifting bodies and their capabilities. *Flight Test Results Pertaining to the Space Shuttlecraft* was directed at the space shuttle community and the event drew participants from most of the NASA Centers, the Air Force, the expected aerospace industry members—aircraft and missile companies—as well as navigation and controls companies. (The only conspicuous attendee was Stan M. Cobb, present on behalf of Pan American Airways.²²⁰) The meeting was broken into two halves: lifting body flight test results, and space shuttle orbiter oriented studies. Center and Air Force engineers spoke, followed by pilots, each in his way pointing to issues and solutions as well as characteristics of the proposed spacecraft. Said Center engineer John McTigue: "The objectives of the flight test program were to investigate approach and landing tasks, landing techniques and pilot procedures, evaluate handling characteristics of the class of vehicle for the terminal portion of the flight," as well as correlate wind tunnel data.²²¹ From this came years of experience in free-flight and dead-stick approach and landing. Bill Dana, one of the Center's X-15 and lifting body research pilots told the audience, "The basic approach pattern used for the lifting bodies was inherited from the X-15 program. The pattern began at the high key point." The pilot flew a large circle while descending rapidly and lined up for the final approach to the runway. "It was natural to transfer these techniques to the lifting bodies," he added, and it worked well.²²²

the rescue craft for three astronauts stuck in Earth orbit. X-23A PRIME (Precision Reentry Including Maneuvering reEntry) was a sub-scale version of the shape and the only one of the original lifting bodies to operate in all flight regimes. Three X-23As went through atmospheric entry; the X-24A completed only approach and landings.

²¹⁷ G. P. Layton Jr., "Summary of Primary Results of the Lifting Body Program," in *Flight Test Results Pertaining to Space Shuttlecraft*, June 30, 1970, NASA TM X-2101, (Edwards, CA: NASA Flight Research Center, 1970), pp. 89-98.

²¹⁸ Joe H. Engle, NASA Johnson Space Center Oral History Project, interviewed by Rebecca Wright, with assistance from Sandra Johnson and Jennifer Ross-Nazzal, Houston Texas, May 27, 2004, p. 21. See also Request for Proposal 9-BC421-67-2-40P, "Space Shuttle Proposal," Houston, TX, March 17, 1972, in which NASA asked candidate companies to submit proposals for orbiters with three possible missions. Mission 2 called for "carrying 25,000 pounds into a 310-mile 55 degree orbit from KSC with air breathing engines." Dennis R. Jenkins, *Space Shuttle: The History of the National Space Transportation System, the First 100 Missions*. 3rd ed., (Cape Canaveral, FL: Dennis R. Jenkins, 2002) and Dennis R. Jenkins, *Space Shuttle: Developing an Icon—1972-2013. Vol. 1: Setting the Stage*, (Cape Canaveral, FL: Dennis R. Jenkins, 2016), pp. 1-324-325, 1-334, 1-371-372, 1-381.

²¹⁹ For a comprehensive discussion of the concepts and proposals, see Chapter 5: "Grand Ambition" and Chapter 6: "Future Revealed," in Jenkins, *Space Shuttle: Developing an Icon—1972-2013. Vol. 1*, pp. 1-177-314.

²²⁰ *Flight Test Results Pertaining to the Space Shuttlecraft*, p. 154.

²²¹ John C. McTigue, "Background and Current Status of the Lifting Body Program," *Flight Test Results Pertaining to the Space Shuttlecraft*, pp. 1-10.

²²² William H. Dana and J[erard] R. Gentry, "Pilot Impressions of Lifting Body Vehicles," *Flight Test Results Pertaining to the Space Shuttlecraft*, p. 74. "An approach normally conducted by a single-engine military aircraft experiencing loss or anticipating loss of engine power or control. The standard approach starts at a relatively high altitude over the runway ("high key") followed by a continuous 180 degree turn to a high, wide position ("low key") followed by a continuous 180 degree turn final." Federal Aviation Administration, FAR/

The conclusion: “unpowered, low lift-to-drag, IFR, landing approaches are practical and realistic for space shuttle recovery.”²²³ Milt Thompson offered concluding remarks. “Our lifting body experience demonstrates that vehicles designed to maneuver hypersonically, in order to achieve substantial aerodynamic cross range can still have acceptable low-speed stability and control characteristics and adequate performance for unpowered horizontal landings.”²²⁴ And while he made light of the zeal inherent in each presenter’s message that day, Thompson admitted what E. O. Pearson from NASA Headquarters understood too clearly: virtually everyone from the Center was advocating an unpowered shuttle in atmospheric flight. “The shuttle, whether it has landing engines or not, must be maneuvered, unpowered, to a point near the destination because the engines cannot be started until the vehicle is subsonic and only limited fuel will be available. To us,” he finished with customary bluntness, “it seems ridiculous to maneuver to a position where power must be relied upon to reach the runway.”²²⁵

At least one person at the Manned Spacecraft Center (MSC) was paying attention to all this. Among the regular flow of letters back and forth between Dale Meyers, then Associate Administrator for Manned Space Flight at NASA HQ, and Robert Gilruth, the Director of the Manned Spacecraft Center is a discussion of engines on the orbiter. The correspondence is mostly concerned with shuttle program costs and contractor activities but midway through the summer Gilruth raised another point: the shuttle’s gross lift-off weight and “whether or not air breathing engines are really necessary on the orbiter.” On July 8, 1970 Gilruth went into more detail: “Several studies supported by data from the Flight Research Center indicate that air-breathing engines are not required on the operational orbiter vehicle. I would like to see the Phase B study guidelines changed so that air-breathing engines could be removed when the full 25,000 pound [11,340 kg] payload is to be carried. For missions where the payload is sufficiently reduced the option to carry the air breathers would be retained.”²²⁶

As the only Center to fly piloted, full-scale lifting bodies, the Flight Research Center had a long and direct association with the type. Reed’s and others’ enthusiasm for and convictions about lifting bodies instilled a pronounced fondness for them at the Center, engendering an abiding, if unsustainable belief in the Center’s centrality to the lifting-body-as-spacecraft idea, as well as an exaggerated sense of the lifting bodies’ connection to the orbiter. Reed later remembered that “NASA and the Air Force... had little confidence in the concept of lifting reentry and... lifting-body vehicles,” suggesting the Center was the only real champion.²²⁷ Yet the Air Force funded the X-20 Dyna-Soar, which dated to 1957 but whose conceptual work predated that (BoMi and RoBo, which the Air Force also funded), the McDonnell ASSET (Aerothermodynamic Elastic Structural Systems Environmental Tests), as well as the X-24A/B, and Eggers urged fellow panel members of the NASA Manned Space Flight Committee to strongly consider lifting bodies as follow-ons to Mercury.²²⁸ Martin Marietta was the most active industry supporter of the concept but it was not the only one; Lockheed also invested in the concept. A broader reading shows the NACA pilots and engineers from Ames and Langley also investigating low L/D approach and landings for such a craft returning from space beginning in the 1950s, and expanding that research in connection with the X-15 in the late 1950s. There is no question that lifting bodies were important in affirming low L/D potential for a re-entry vehicle and energy management, particularly since they, unlike other aircraft, could not resort to better L/D or real thrust to escape a bad

AIM Federal Aviation Regulations/Aeronautical Information Manual 2013, (New York, N.Y.: Skyhorse Publishing, 2012), p. 713.

²²³ Peter C. Hoag and B. Lyle Schofield, “IFR Experience with Unpowered, Low-Lift-to-Drag Ratio Handling Approaches,” *Flight Test Results Pertaining to the Space Shuttlecraft*, p. 119.

²²⁴ Milton O. Thompson, “Final Remarks and Future Plans,” *Flight Test Results Pertaining to the Space Shuttlecraft*, p. 148.

²²⁵ Thompson, “Final Remarks and Future Plans,” *Flight Test Results Pertaining to the Space Shuttlecraft*, p. 148.

²²⁶ Dale D. Meyers, letter to Robert R. Gilruth, May 22, 1970, Dale D. Meyers, letter to Robert R. Gilruth, June 17, 1970, Robert R. Gilruth to Dale D. Meyers, June 29, 1970, and Robert R. Gilruth to Dale D. Meyers, July 8, 1970. References to air-breathing engines appear in Gilruth letters of June 29 and July 8, 1970. Letters courtesy of Jennifer Ross Nazzal, JSC historian, March 17, 2017.

²²⁷ Reed, *Wingless Flight*, p. 8. Publications such as *Developing and Flight Testing the HL-10 Lifting Body: A Precursor to the Space Shuttle* did not undermine this attitude. Robert W. Kempel, Weneth D. Painter and Milton O. Thompson, *Developing and Flight Testing the HL-10 Lifting Body: A Precursor to the Space Shuttle*, (Washington, D.C: NASA, 1994).

²²⁸ Wilfred Dukes and A. Schnitt, “An Introduction to Structural Design for Aerodynamic Heating,” WADC Technical Report 55-305 Pt. II, in Robert Godwin, ed., *Dyna-Soar: Hypersonic Strategic Weapons System*, (Burlington, Ont., Can.: Apogee Book Series, 2003), pp. 12-18; Minutes of Meetings, Panel for Manned Space Flight, in Logsdon and Launius, eds., *Exploring the Unknown: Selected Documents in the U.S. Civil Space Program. Volume VII*, p. 87; and Roy Franklin Houchin, II, “The Rise and Fall of Dyna-Soar: A History of Air Force Hypersonic R&D, 1944-1963,” (Ph.D. Dissertation, Auburn University, 1995). BoMi: Bomber-Missile; RoBo: Rocket-Bomber.

approach and landing.²²⁹ (This is not unlike the LLRV/LLTV's value as a simulator since the astronauts could not reset to correct for a botched landing.) But the connection between the X-24B demonstration flights and the elimination of air-breathing engines on the orbiter is difficult to support (not necessarily the case for the argument about the overall lifting body and specifically low L/D experience and air breathing engines, as Gilruth's remarks indicate.)

At the end of the 1950s, for instance, in a project derived from the lifting body work, three Ames researchers studied "power-off landing techniques applicable to re-entry vehicles. Considerations of weight suggest that the vehicle be without means of propulsion at this stage of the flight," wrote the authors about the reusable spacecraft they had in mind. They had five pilots fly a total of 28 landings in L/D configurations of 4 and 2.8 (two pilots from Ames and one each from the Air Defense Command, the Air Force Flight Test Center, and the Flight Research Center). "Measured data and pilot opinion indicate that the proposed approach technique is practical for power-off landings of aircraft having high wing loadings and low lift-drag ratios."²³⁰ Richard Bray, Fred Drinkwater, and Maurice White published their results in 1960.

In 1970, the Flight Research Center and Ames conducted another set of tests to further refine the models NASA had for low L/D approach and landings. Unlike previous tests that relied on small aircraft (typically fighters with high wing loadings but that were comparatively light when matched with the proposed orbiter) this testing used a Convair CV-990 airliner that weighed between 172,000 and 190,000 pounds (78,018 and 86,182 kg), depending on its setup; its selection was to more accurately simulate anticipated orbiter weights at landing, and, thus, the flight characteristics of the orbiter. Eight pilots with different skills and backgrounds flew nearly 90 different kinds of unpowered (thrust at idle) approach and landings. The group included two airline pilots with no experience in the CV-990 or the task before them, two lifting body pilots, four engineering test pilots, and an Air Force test pilot. On top of this, five astronauts were invited to fly approaches. "After observing other pilots perform these maneuvers, the five astronauts experienced no particular difficulty performing the approaches. None of the approaches had to be abandoned because of energy management difficulties."²³¹ In addition to the visual approaches, the pilots flew "hooded" approaches using the instrument landing system (ILS), and while it was unusual to fly an unpowered ILS approach and landing in an airliner, the pilots had no real difficulties. Flights took place at Edwards AFB.

Also in 1970, Berwin Kock and Fitzhugh "Fitz" Fulton, both of the Flight Research Center, presented a paper on "Approach and Landing Studies" at the *Flight Test Results Pertaining to the Space Shuttlecraft* conference. They described comparison approach and landing tests between the Northrop HL-10, a B-52, and a CV-990, flown by a number of pilots. (In this instance, the HL-10, flown by lifting body pilots only, operated with 1,500 pounds of thrust [6.67 kN] courtesy of H₂O₂ thrusters in order to maintain a steady glide slope in the tests.)²³² The presenters were almost all from the Flight Research Center—although this did not imply any necessary parochialism: lifting bodies were embraced by Ames and Langley even if those Centers did not fly them. Kock and Fulton's tests were followed by another set—again with a CV-990—performed at Ames, yielding a report which appeared in 1972. Thus, when Milt Thompson said it "seems ridiculous to maneuver to a position where power must be relied upon to reach the runway," he addressed less the choir than the congregation.²³³

²²⁹ Albert E. von Doenhoff, and George W. Jones Jr., *An Analysis of the Power-Off Landing Maneuver in Terms of the Capabilities of the Pilot and the Aerodynamic Characteristics of an Airplane*, NACA TN 2967, (Langley, VA: Langley Aeronautical Laboratory, 1953), Fred J. Drinkwater III and George E. Cooper, *A Flight Evaluation of the Factors which Influence the Selection of Landing Speeds*, NASA Memo 10-6-58A, 1958), Gene A. Matranga and Neil A. Armstrong, *Approach and Landing Investigation at Lift-Drag Ratios of 2 to 4 Utilizing a Straight-Wing Fighter Airplane*, NASA TM X-125, (Edwards, CA: NASA Flight Research Center, 1959), Gene J. Matranga, and Joseph A. Menard, *Approach and Landing Investigation at Lift-Drag Ratios of 3 to 4 Utilizing a Delta-Wing Interceptor Airplane*, NASA TN-D-323, (Edwards, CA: NASA Flight Research Center, 1960), and Gene J. Matranga, *Analysis of X-15 Landing Approach and Flare Characteristics Determined from the First 30 Flights*, NASA TN D-1057, (Edwards, CA: NASA Flight Research Center, 1961).

²³⁰ Richard S. Bray, Fred J. Drinkwater III, and Maurice D. White, *A Flight Study of a Power-Off Landing Technique Applicable to Re-entry Vehicles*, NASA TN D-323, (Moffett Field, CA: NASA Ames Research Center, 1960), pp. 2, 9. Oddly, the type of aircraft in the test is not identified.

²³¹ Berwin M. Kock, Fitzhugh L. Fulton, and Fred J. Drinkwater III, *Low-Lift-to-Drag-Ratio Approach and Landing Studies Using a CV-990 Airplane*, NASA TN D-6732, (Edwards, CA: NASA Flight Research Center, 1972), pp. 3, 7, 8.

²³² Kock, Fulton and Drinkwater, *Low-Lift-to-Drag-Ratio Approach and Landing Studies Using a CV-990 Airplane*. Kock and Fulton worked with Drinkwater on this project, making the oversight puzzling since theirs was certainly not the first use of an airliner to mimic the weight and flight characteristics of an anticipated spacecraft making its return for a landing on a runway.

²³³ It is around this same time—in 1970—that the Flight Research Center published *Experience with the X-15 Adaptive Flight Control System* (TN D-6208), a report meant to highlight the Center's relevant experience with a reusable space plane.



USAF Major Mike Love standing on Rogers Dry Lake in front of the X-24B (upper left). NASA E-29374 John Manke in front of the M2-F3. NASA EC72-3448

All of this had an effect. Whether it was Gilruth's questions as MSC Center Director, the 1970 tests, the 1972 tests, or a compilation of work over more than a decade, the turning point came in 1972. On September 12 of that year the Shuttle Program Office held an Orbital Management Review to discuss, among other things, ABPS (Air Breathing Propulsion Systems, sometimes referred to as ABES for Engine Systems). "After technical consideration, NR recommended the deletion of the ABES from orbital missions at a cost savings of approximately \$50 million to the program including system development. Direction: proceed with providing the ABES only for ferry flights ..."²³⁴ The Program had long been concerned about the focus that operating such engines demanded of a pilot in the midst of other tasks, something the Ames and FRC tests looked at. How long it took to deploy and start such engines was another topic; so too, was whether or not a single pilot could do all this without being unduly distracted at critical moments during the flight (should the other pilot be incapacitated). As late as March 1972 a NASA Request for Proposal (RFP) listed Air Breathing Engines as part of the shuttle, to be used for repositioning the orbiter after landing (flying back to its launch site) or to allow up to 15 minutes of loiter time at 10,000 feet (3 km) before landing.²³⁵ The September 12 agenda shows that both North American Rockwell, the shuttle's builder, and NASA favored deleting ABES for orbital missions. The agenda itself was blunt: "make the decision to delete the ABES now."²³⁶ On September 21, Robert Thompson, Space Shuttle Program Manager, officially eliminated air-breathing engines from the orbiters.²³⁷ Not one year

²³⁴ Space Shuttle Orbiter Management Review, NASA-MSC", SSV72, September 12, 1972, p. 4.

²³⁵ RFP 9-BC421-67-2-40P, "Space Shuttle Program," (Houston, TX: NASA 17 March 1972), IV-6, IV-9, in Jenkins *The History of the National Space Transportation System*, p. 173.

²³⁶ "Space Shuttle Orbiter Management Review, NASA-MSC", SSV72, September 12, 1972, p. 78.

²³⁷ Dennis Jenkins, email to Christian Gelzer, August 19, 2016. Another source places the date in 1974, but either way the decision predates the X-24B flights in 1975; Robert F. Thompson, Oral History Interview by Kevin M. Rusnak, October 3, 2000, Johnson Space Center Oral History Project, pp. 22-23, http://www.jsc.nasa.gov/history/oral_histories/ThompsonRF/thompsonrf.htm, accessed

later Frederick Edwards and John Foster, of Ames, published *Flight Test Results from the CV 990 Simulated Space Shuttle During Unpowered Automatic Approaches and Landings*. “The shuttle will have a lower L/D [than a large jet transport] and will be unpowered in the approach.”²³⁸ Curiously, air-breathing engines continued to make appearances in the shuttle plans for the next three years, but only for ferry flights: there was no longer any thought of using them on missions.²³⁹

The flights by Manke and Love were not the first to demonstrate to NASA the low L/D flight characteristics of an aircraft such as the shuttle and were not what changed the shuttle program’s mind about air-breathing engines going to space and back, but theirs were the first approach and landings to a paved runway by an actual, unpowered lifting body - one that had no ability to execute a go-around. The engineering and flight test work done by those at the Center, as well as those at Ames and Langley, was critical in eliminating the jet engines, which reduced the empty weight of the space shuttle orbiter and increased its payload. Crucially, theirs was the culmination of nearly three decades of design, test, and validation that one could actually fly back from space. John Manke and Maj. Mike Love were instrumental in the plan to demonstrate a low lift-to-drag aircraft’s ability to fly to and land on a paved runway, and touch down with enough precision that its landing wouldn’t be a hazard.²⁴⁰

The sum of the lifting body and X-15 work spanning the physical nation, at least three NASA Centers, the Air Force Flight Dynamics Laboratory as well as industry, and including launching sub-scale lifting bodies to test re-entry techniques, not to mention the approach and landing of small and large aircraft, demonstrated the viability of flying back from space and landing like an airplane. As a space transport system, lifting bodies never did shed all of the problems associated with them: going to space while carrying large cargo entailed much larger vehicles than alternate systems, detracting from their value. But they seemed a good way to come home, even though at their peak appeal there was no workable reusable thermal protection system to deal with the inevitable portion of re-entry even a lifting body must endure. Still, the concept’s imprint was deep: winged or un-winged, a non-ballistic re-entry from space, one that allowed you to fly to a landing at a designated airport in a craft that was reusable proved the winning Space Transportation System idea.

In 2011 Dale Myers, former NASA Deputy Administrator, remarked: “Thank God we’d had all this lifting body experience, when these guys had landed the low L/D devices.” Like many, he overlooked the wide range of research and testing done with aircraft other than lifting bodies that contributed directly to the space shuttle program. Nevertheless, combined, all of it paved the way for the orbiter and its limited gliding ability, which was, it turned out, better than the lifting bodies.²⁴¹

November 10, 2016. See also Jennifer Ross-Nazzari and Dennis Webb, “The Historical Legacy,” in *Wings in Orbit: Scientific and Engineering Legacies of the Space Shuttle*, ed. Helen Lane, (Washington, D.C.: NASA, 2001), p. 16.

²³⁸ Frederick G. Edwards and John D. Foster, *Flight Test Results from the CV-990 Simulated Space Shuttle During Unpowered Automatic Approaches and Landings*, NASA TM X-62,285, (Moffett Field, CA: NASA Ames Research Center, 1973), p. 3.

²³⁹ There remained the matter of attaching jet engines to the bottom of the shuttle wings for ferry flights without compromising the TPS.

²⁴⁰ NASA, and particularly Dryden, generated more than a few technical papers and reports on low L/D aircraft by the time Manke and Love made their runway landings. The total number of formal reports for just the early low L/D vehicles is: M2-F1: 2, M2-F2: 15, M2-F3: 14, HL-10: 12, X-24A: 7, X-24B: 1, Hyper III:1, and X-15: 361.

²⁴¹ Dale Myers, Lecture 1, in Jeffrey Hoffman, *16.885J Aircraft Systems Engineering, Fall 2005*. (Massachusetts Institute of Technology: MIT OpenCourseWare), <http://ocw.mit.edu>, accessed May 19, 2011. License: Creative Commons BY-NC-SA; guest lecturer Dale Meyers.

6: Free Enterprise: The Approach and Landing Test Program and the Development of the Space Shuttle Orbiter

Peter W. Merlin

JT3

Edwards Air Force Base

Abstract:

OV-101, the prototype space shuttle orbiter (Enterprise), underwent a series of captive carry flights, followed by five free-flights, all released from the Boeing 747 shuttle carrier aircraft for the Approach and Landing Tests. These tests confirmed some assumptions and certain systems on board, while revealing some problems.

Keywords:

Fred W. Haise Jr.; C. Gordon Fullerton; Joe H. Engle; Richard H. Truly; Fitzhugh L. "Fitz" Fulton Jr.; Thomas C. McMurtry; 747-100

The space shuttle orbiter was the first spacecraft designed with the aerodynamic characteristics and in-atmosphere handling qualities of a conventional airplane. In order to evaluate the orbiter's aerodynamic flight control systems and subsonic handling characteristics, and to test various systems on board the vehicle, the Flight Research Center undertook a series of flight tests, known as the Approach and Landing Test (ALT) program, at Edwards Air Force Base, CA, in 1977. The ALT program demonstrated the ability to safely approach and land an orbital flight vehicle from space. NASA's Johnson Space Center (JSC) managed the program, while the test flights were conducted at the Flight Research Center and the Air Force Flight Test Center (AFFTC). The Edwards test site was selected because it included an instrumented test range (the Western Aeronautical Test Range) with an extensive safety buffer zone and a 44 square-mile dry lakebed capable of supporting the landing weight of the space shuttle orbiter, and in part because the Center had an extensive history of successfully flight-testing extraordinary aircraft, including the world's first exo-atmospheric vehicle, the X-15, and all of the lifting bodies.²⁴² The Center had also conducted preliminary approach and landing tests using different aircraft with a shuttle-like vehicle in mind, before the shuttle was selected.²⁴³

Rockwell International built a full-scale orbiter prototype, christened Enterprise and designated OV-101 (Orbital Vehicle) for the ALT.²⁴⁴ The majority of OV-101's structure was made of aluminum alloys. Since it wouldn't be subjected to re-entry heating, the orbiter was not covered with reusable surface insulation, but rather with substitute materials - primarily polyurethane foam and fiberglass. Nevertheless, the OV-101 was true to the outer mold lines of the planned orbiter. The flight deck had two crew stations: the commander (left) and pilot (right) with displays and controls allowing crewmember to land the vehicle. Aerodynamic controls included a body flap at the aft end, elevons, and a split rudder that doubled as a speed brake. Reaction control systems, unnecessary at low altitude, were not installed. For the captive carry flights and the first three free-flights an aerodynamic fairing covered the aft end of OV 101, where the shuttle orbiter's main engines would be located. On the last two flights, three dummy main engines and nozzles were installed to simulate the weight characteristics of the operational orbiter, and the fairing was removed to simulate the flying conditions of the actual orbiters.

The test orbiter Enterprise was designed for a planned landing speed of approximately 185 knots (343 km/hr) and could be landed manually or by computer. In an autoland approach the computer guided the orbiter to the runway by determining its heading and speed using the inertial navigation system, a microwave scanning beam landing system (MSBLS), and other data sources. NASA purchased a commercial Boeing 747-100 from Japan Airlines, which the Boeing Company modified into a shuttle carrier aircraft (SCA) to transport Enterprise to altitude for the captive carry and free-flight tests. Except for a few rows of first class

²⁴² The author acknowledges C. Gordon Fullerton for taking the time to review the original draft of this paper and his lengthy, detailed explanations of the space shuttle orbiter flight control systems.

²⁴³ Berwin M. Kock and Fitzhugh L. Fulton, Jr., *Approach and Landing Studies*, NASA TM X-2101, (Edwards, CA: NASA Flight Research Center, 1970).

²⁴⁴ Initially to be named *Constitution* in recognition of the nation's bicentennial, a write-in campaign by fans of the television series Star Trek successfully convinced the Agency to change its plans and the aircraft was formally christened Enterprise.

seats on the lower and upper deck, all of the passenger accommodations and related equipment on the 747-100 were removed and parts of the fuselage underwent structural reinforcement to support the weight of the orbiter. Support struts (two aft and one forward) were installed atop the fuselage of the 747-100 to hold the orbiter. At the beginning of each free flight, explosive bolts released the orbiter from the SCA. Tip fins were added to the SCA horizontal stabilizers to increase directional stability because the orbiter, with or without its aerodynamic tailcone fairing, disrupted airflow over the SCA vertical stabilizer. Unlike the rudder on the SCA vertical stabilizer, however, the tip fins were fixed. An escape slide was installed in the 747 (now registered as N905NA) for crew use in case of an emergency (OV-101 was equipped with ejection seats), including pyrotechnics to open an escape hatch in the side of the fuselage. The emergency escape for the 747 crewmembers entailed grabbing a rope in the upper deck, sliding down through holes cut in the upper and main deck floors, and out a hole in the fuselage's side that was opened explosively. The 747 flight crew wore parachutes during the ALT flights.



Enterprise mated to the SCA conducting captive-carry flights at Edwards AFB. NASA ECN-6887

For captive-inert flights, Center personnel performed real-time flight control functions from one of the Center's control rooms. Flight controllers at JSC were responsible for those flights during which the orbiter was manned. The captive-active and free-flight tests were coordinated from Mission Control in Houston, TX. NASA selected two two-man orbiter crews for the ALT: Fred W. Haise Jr. (commander) and C. Gordon Fullerton (pilot), and Joe H. Engle (commander) and Richard H. Truly (pilot). Crewmembers for the 747 SCA included pilots Fitzhugh L. "Fitz" Fulton Jr. and Thomas C. McMurtry, and flight engineers Victor W. Horton, Thomas E. Guidry Jr., William R. Young, and Vincent A. Alvarez.²⁴⁵

While the SCA/orbiter combination did not constitute the first time one aircraft had been carried atop another and launched, it was by far the largest and heaviest combination so far to do this. Some wags referred to the mated duo as the "world's largest biplane."²⁴⁶ There were, in fact, a number of risks. NASA engineers

²⁴⁵ "Press Kit: Space Shuttle Orbiter Test Flight Series," Release No. 77-16, (Washington, D.C.: NASA, February 4, 1977).

²⁴⁶ Richard P. Hallion, and Michael H. Gorn, *On the Frontier: Experimental Flight at NASA Dryden*, (Washington, D.C.: Smithsonian Books, 200), 2nd ed., p. 237. In 1938, British Imperial Airways began operating the *Maia Mercury* combination to carry mail across the Atlantic Ocean. Short Brothers built both four-engine, propeller aircraft. *Maia* carried *Mercury* partway across the Atlantic on its back: at a predetermined point, *Mercury* powered up, then separated from *Maia* and continued the transoceanic flight on its own while *Maia* turned for home. This unusual arrangement was used because aircraft of the period had such limited range and payload, leaving the user to choose one or the other. A. J. Jackson, *British Civil Aircraft Since 1919*, Vol. 3, (London: Putnam, 1974), and C. H. Barnes,

were concerned that the tip plates on the SCA horizontal stabilizers, along with turbulence from the orbiter's aft end would create excessive loads on the SCA tail. The orbiter was fitted with an aerodynamic tailcone to reduce buffeting on the SCA vertical tail but the cone had to be removed for the final flights in order to study the aerodynamics of the orbiter's operational configuration, something that generated controversy within the program. Removing the tailcone would also reduce the orbiter's lift-to-drag (L/D) ratio, changing its flight characteristics. In addition, the flight crews of the two aircraft had to perform in a highly integrated fashion because they could not see one another. There was also the question of what would happen after separation: would Enterprise safely fly away or would it slide back and strike the SCA vertical stabilizer? These concerns were real enough to install the rope-and-explosive-escape hatch system for the SCA flight crew.

Prior to the ALT, engineers conducted wind tunnel model tests and manned simulations and made computational predictions for the performance of the two airplanes. The results gave planners confidence that the SCA and orbiter crews could safely perform the separation maneuver. Investigations showed that, because of the positive angle of attack (AoA) of the orbiter when attached to the SCA, an initial relative normal load factor of more than 1g was attainable for the entire gross weight of the vehicle: the two airplanes were found to separate naturally. In the models, the orbiter tended to climb and fly straight up relative to the SCA and the SCA tended to descend mildly as the crew idled the engines and deployed spoilers, allowing the orbiter to clear the SCA tail in about 1.5 seconds.²⁴⁷

In the face of all this, the potential value of the ALT program outweighed the challenges and risks. From the beginning the flights were justified on the basis of the need to conduct a complete operational check of the orbiter's systems. The ALT flights also allowed accurate flight calibration of the orbiter's air data system and, especially during the tailcone off flights, provided accurate L/D data. Most important, the ALT program would provide experience that could not be gained from wind tunnel tests or simulation. It would give the crews hands-on experience and familiarize the pilots with the cockpit systems and the "procedural aspects of landing under conditions that are much easier to control than on the Orbital Flight Tests (OFT)."²⁴⁸ There really wasn't any question of doing this portion of the flight test in an unmanned vehicle, either.²⁴⁹

In typical fashion for the Center, the ALT program consisted of a series of incremental steps leading up to a final free-flight demonstrating the capability of Enterprise to land on a paved runway. The first phase of the program involved airworthiness and performance verification of just the modified 747. Along with structural modifications made to accommodate the orbiter, the airplane's engines had been changed to the Pratt & Whitney JT9D-7AH configuration, allowing rated takeoff thrust in flight for a maximum of 20 minutes.²⁵⁰ The next step consisted of three taxi tests on the main runway at Edwards. NASA engineers were concerned about SCA landing gear taxi loads due to the high center of gravity (cg) and heavy gross weight in ferry condition.²⁵¹

Technicians instrumented the SCA nose gear with strain gages to measure vertical, drag, and side loads at the axle. Engineers also wanted to study buffeting of the SCA vertical stabilizer at near-takeoff speeds because excessive buffeting could lead to fatigue damage, limiting the useful life of the SCA for ferry operations between Edwards and the Kennedy Space Center. The Flight Research Center aerostructures team found calibrated strain gage measurements valuable in detecting critical tail loads and taxi turn limitations, verifying launch incidence and elevon settings, and monitoring empennage buffet. OV-101 was placed atop the SCA at

Shorts Aircraft Since 1900, (London: Putnam Aeronautical Books, 1967).

²⁴⁷ H. A. Pope, "ALT Manned Simulations – Orbiter/747 Separation," NASA JSC Engineering Analysis Division briefing, Houston, TX, January 20, 1975. File Folder L1-5-2-7, files of Milton O. Thompson, NASA AFRC Historical Reference Collection.

²⁴⁸ H. A. Rediess, memorandum to DFRC Shuttle Projects Manager from Director of Research re. Assessment of ALT Tests with Tailcone On vs. Off, (Dryden Flight Research Center, 17, 1976). File Folder L2-1-3C-6, Space Shuttle files, NASA AFRC Historical Reference Collection.

²⁴⁹ "It would have been very difficult to have devised a scheme, in my view, to have flown that program unmanned. I guess you could've used an RF link and had a pilot on a stick on the ground like they have flown some other programs. But to totally mechanically program it to do that would have been very difficult for that part of the program." Fred W. Haise, Jr. Interviewed by Doug Ward, Houston, TX – March 23, 1999, Johnson Space Center Oral History Project.

²⁵⁰ Robert G. Hoey, et al., "AFFTC Evaluation of the Space Shuttle Orbiter and Carrier Aircraft – NASA Approach and Landing Test," AFFTC-TR-78-14, Office of Advanced Manned Vehicles, Edwards, CA, May 1978. The engines were changed out by Qantas; Rick Brewer, telephone interview with Christian Gelzer, January 30, 2012, NASA Dryden. NASA AFRC Historical Reference Collection.

²⁵¹ A. L. Carter, deputy chief, Aerostructures Division, memorandum to Milton O. Thompson, chief engineer re: Review of Shuttle Carrier Aircraft (SCA) Structural Issues, July 13, 1977. File Folder L2-1-3A-2, Space Shuttle files, NASA AFRC Historical Reference Collection.

the Center using the mate-demate-device (MDD), and on February 15, 1977, the pilots completed three taxi runs, reaching top speeds of 78, 122, and 137 knots indicated airspeed (KIAS). The SCA test team evaluated techniques for setting takeoff thrust, directional stability and control, elevator effectiveness, pitch response, thrust-reverser effectiveness, and airframe buffet. They found nothing to prevent proceeding with flight tests.²⁵²

Captive Carry Flight

Five captive carry flights with the inert and unmanned Enterprise followed, to verify the airworthiness of the SCA747 as an orbiter transport vehicle and to establish an operational flight envelope for ALT operations.²⁵³ These flights provided data on flutter margins, empennage loads during maneuvers, buffet resulting from the mated configuration, and the effects of SCA/orbiter longitudinal trim modifications. NASA engineers also wanted to verify interface loads and corresponding flight conditions to ensure positive launch separation and launch-abort maneuvers. The final captive-inert flight was devoted to flying two simulated launch profiles. The SCA crew successfully demonstrated that the 747 had the necessary performance capabilities to climb to the desired altitude and accomplish the launch maneuver. The flights also confirmed that the SCA crew could safely return to base with the orbiter if a launch were aborted.

In the captive-active phase, Enterprise was powered up with the crew aboard while mated to the SCA. For both crews' safety, provisions were made for separating the orbiter in the event of emergency. Three flights were conducted to verify the separation profile as well as orbiter stability and performance in the mated configuration with combined operation of the primary flight control system, auxiliary power units, hydraulics, and structure. Orbiter vertical tail buffet data obtained during speed brake and rudder operation at 180 knots indicated no significant adverse oscillations. Flutter clearance tests, performed during the second flight at speeds up to 270 knots, revealed no sustained vibrations. The orbiter's dynamic response to rapid control inputs from both the orbiter and SCA was highly damped and considered satisfactory. Tail buffet was measured at incremental speed brake settings and various rudder deflections, resulting in structural responses that were well within limits. An autoland fly through allowed Enterprise crew to verify that the attitude indicator and horizontal situation indicator displayed accurate indications, and the landing gear was lowered to verify that it functioned properly.²⁵⁴ The Enterprise crew deployed the landing gear on the third captive active flight during the practice descent phase. Data from the second and third flights showed that the operational separation profile and procedures were satisfactory for the first planned free-flight. The captive-active flights also demonstrated that the orbiter's hardware and software met the ALT requirements, and that support operations including turnaround, mission control, and mission evaluation were satisfactory.²⁵⁵

"The flights on the back of 747 were unusual in a couple of respects, one a real surprise," recalled Haise. "When we first rode on top, you couldn't see the 747, no matter how you'd lean over and try to look out the side window, you couldn't view any part. It was kind of like a magic carpet ride. It was deceptive sitting up that high. Things looked like [they were] going slower than [they were], and [on] the first takeoff I really thought Fitz had rotated too early. It didn't look like we were going fast enough."²⁵⁶ The SCA crew sat three stories above the ground; the Enterprise crew sat at least two stories above that.

Free-Flight

The final phase of the ALT program included five free-flights in which Enterprise released from the SCA and glided to a landing at Edwards AFB. The tests demonstrated the capability of the orbiter to safely

²⁵² Approach and Landing Test Evaluation Team, "Space Shuttle Orbiter Approach and Landing Test – Final Evaluation Report," JSC-13864, (Houston: NASA Johnson Space Center, February 1978).

²⁵³ W. H. Andrews, "Space Shuttle Orbiter Approach & Landing Test – Mated Inert Flight Test Plan," NASA DFRC, Edwards, CA, January 28, 1977.

²⁵⁴ "Autoland" describes a system that fully automates the landing procedure using guidance cues from the flight guidance computer.

²⁵⁵ Fullerton remarked on more than one occasion that the most discomfiting part of these flights was not during taxi or in flight while attached to the Boeing 747, but when leaving the orbiter after the return to the Center. Still mounted atop the SCA some 60 feet in the air, he had to emerge from the shuttle's small, mostly circular side hatch and step into the basket of a swaying "cherry picker" extended all the way out to collect the two Enterprise crewmen. No one dared let the basket touch the orbiter lest it damage the vehicle, so he had to make something of a leap of faith across 18 inches of air. "I didn't like that." C. Gordon Fullerton, conversation with Mary Ann Harness, June 19, 2012.

²⁵⁶ Haise, Jr., interviewed by Doug Ward, Houston, TX – March 23, 1999, Johnson Space Center Oral History Project.

approach and land on a runway in a variety of cg configurations within its flight envelope. The first four flights ended on runways marked on the dry lakebed, some of which were placed there for the orbiter's precursors, the X-15 and the lifting bodies. The final flight concluded with touchdown on the base's concrete runway in order to obtain data on tire/pavement interface and qualify the deceleration system. For all five flights, Enterprise was ballasted with a gross landing weight of approximately 150,000 pounds (68,038 kg), considered a lightweight orbiter; this turned out to be far lighter (by 37,000 pounds) (16,783 kg) than any operational orbiter returning from space. During the first three flights Enterprise flew with the tailcone on and with two different cg configurations. These were based on a pitch static-margin equivalency for the tailcone-off configuration and a flight control system test requirement to have a cg spread of 2% of the reference body length. Engineers knew that a forward cg resulted in a more stable static margin (the difference between



Enterprise separates from the SCA. The bipod used during the Approach and Landing Tests was slightly taller than that used during later ferry flights to give Enterprise a greater angle of attack at separation. NASA E77-33085

the vehicle's center of lift and center of gravity). The final two free-flights, with the tailcone removed and replaced with dummy shuttle main engines, were conducted with the cg at 66.25% to simulate the planned cg for the initial orbital flight test.

Truly, Engle, Haise, and Fullerton had all undergone extensive training in the shuttle simulator flying sample approaches in different configurations by this time. They had tried different things in the process and confronted different problems along the way. Nevertheless, this was the real aircraft, with real systems, in a real environment, not a controlled laboratory.²⁵⁷ (In 2011 Robert Crippen admitted surprise that neither he nor John Young were given the chance to fly Enterprise in free-flight inasmuch as the two were the first to fly an orbiter back from space.²⁵⁸)

The first free flight, on August 12, 1977, began with orbiter separation from the SCA at an altitude of

²⁵⁷ As part of the Mission Simulator and Training Facility at JSC in 1976 NASA installed a Link-built Motion Based Simulator specifically for the orbiter to train its pilots. The first direct opportunity for its use came when "the MBS was used to train crews for the Approach and Landing Test (ALT) program from 1976-77." *Jake Garn Mission Simulator and Training Facility, Building 5: Historical Documentation*, (Houston, TX: NASA Johnson Space Center, 2010), p. 14. See also L. Jerry Swain, NASA Johnson Space Center Oral History Project, interviewed by Jennifer Ross-Nazzal, 2 October 2009, http://www.jsc.nasa.gov/history/oral_histories/SwainLJ/SwainLJ_10-2-09.htm, accessed December 4, 2014.

²⁵⁸ Robert Crippen, conversation with Jay Levine, April 15, 2011. NASA Dryden Flight Research Center.

approximately 22,800 feet (6.949 km) above ground level (AGL) and at 270 knots equivalent airspeed (KEAS). Haise and Fullerton executed two 90 degree left turns during descent and landed on lakebed runway 17 just 5 minutes 22 seconds after separation. Touchdown was approximately one mile beyond the predicted landing point. The crew performed steering, braking, and coasting tests during the 11,000-foot (3,353 m) rollout. Said Tom McMurtry, co pilot on the SCA:

‘Fitz’ Fulton and I had done a lot of simulation work, [but] there were still questions about whether or not it going to actually happen as we expected from those simulations and analysis. We had practiced the descents and we’d gone right up to the point where the shuttle would separate, so this was the final determination on how it was going to work. There was a very positive, loud thump when the shuttle separated. There was always the question of whether the shuttle was going to slide back and hit the tail of the 747 or not; we couldn’t see the tail but we could, after a few seconds, tell it didn’t hit us and then the chase called ‘clear!’ so we knew that the shuttle had separated high enough that it could then fly away from the 747.²⁵⁹

Separation for free-flight 2 (FF-2), piloted by Engle and Truly (the crews alternated for each flight), occurred at an airspeed of 270 KEAS and 23,200 feet (7.07 km) AGL. The crew performed a 1.8-g wind-up turn to the right of about 135 degrees and then a 45-degree left turn. They completed various programmed stick inputs for flight control system and structural evaluation. Following 5 minutes 31 seconds of free-flight, Enterprise touched down on runway 15. During roll-out, with heavy, moderate, and differential brake application, a “chattering” phenomenon surfaced as the natural frequency of the gear struts resonated with the anti-skid control gains.

The orbiter’s cg was moved aft from 63.8% to 65.8% of the reference body length for FF-3 to simulate tailcone-off stability characteristics at 67%. Haise and Fullerton separated from the SCA at 250 KEAS and 24,100 feet (7.345 km) AGL, performed wind-up turns of 140 degrees and 40 degrees, as well as test inputs and aerodynamic stick inputs as on the previous flight. Closed-loop automatic guidance was employed after the final turn and Enterprise landed on lakebed runway 17 with 5 minutes 35 seconds of flight time. After coasting for 23 seconds, the crew applied gentle to moderate differential braking, beginning at a speed of about 150 knots. When hard braking was applied at low speeds (from 115 to 20 knots), the chattering effect reappeared. This low-frequency vibration was so violent that Fullerton, the pilot, said later: “I thought we were going to shake the wings off.”²⁶⁰ Following that flight, engineers developed changes to the anti-skid system in order to eliminate the brake chatter.

Free flight 4 was the first tailcone-off flight. The SCA crew flew two circuits of a racetrack pattern, extending approximately 70 miles (112.6 km) from Edwards, to gather flightworthiness and buffet data since this was the first flight with Enterprise in this configuration. Back close to the lakebed the orbiter separated from the SCA at 245 KEAS and an altitude of 17,700 feet (5.39 km) AGL. During the 2 minutes and 35 seconds of glide flight, Truly and Engle performed an AoA sweep and aerodynamic stick inputs to collect data on performance, stability and control, and flight handling qualities. Only two turns of 10 degrees each were made to align with runway 17. Enterprise touched down on the lakebed 510 feet (155.5 m) beyond its planned landing point and rolled 5,725 feet (1.745 km). The crew performed braking and nose wheel steering tests during the landing roll and encountered no brake chatter.

The ALT flights had a number of clear results. Taxi tests and inert captive-carry tests demonstrated that the 747 100 SCA/orbiter pairing posed no inherent risks beyond the ordinary. With or without the tailcone on the orbiter, the SCA was controllable, in flight as well as during takeoff and landing. Moreover, carrying an orbiter on the top of the SCA with the tailcone on did not subject the carrier aircraft to undue stress at any point. The free-flights of Enterprise validated the shuttle’s flight characteristics as well as its approach and landing capabilities on lakebed runways, with various centers of gravity. Among the issues to deal with was the brake chatter that surfaced as the natural frequency of the gear struts resonated with the anti-skid control gains. And, despite the good verisimilitude of the ground-based simulator at JSC and the airborne simulator (a modified Gulfstream GII), like the Lunar Landing Research Vehicle (LLRV), Enterprise gave its pilots no chance for a

²⁵⁹ Tom McMurtry, interviewed by Guy T. Noffsinger Shuttle Documentary Interviews, October 2010. Original questions and responses amended and expanded in April 2011 and February 2012.

²⁶⁰ C. Gordon Fullerton, conversation with Peter Merlin, September 2006.

re-do once separated from the SCA, no re-set button to push if things didn't go as planned or expected. In that respect, the first four free-flights were valuable strictly from the piloting perspective, by and large affirming the computer models. One more free-flight remained, and this one proved especially important for the shuttle program and its pilots. Taken together, the entire ALT effort was more critical to the eventual shuttle program than might appear at first blush.

Three of the four astronauts who flew the ALT went on to serve as pilot and or commander of shuttle missions; Haise finished his NASA career without returning to space.

7: Thermal Protection System and the Flight Loads Laboratory

Christian Gelzer

Logical Innovations, Inc.

NASA Armstrong Flight Research Center

Abstract:

Rockwell International, the builder of the space shuttle orbiter, contracted the AFRC Flight Loads Laboratory (FLL) to perform a thermodynamic test on the shuttle's elevon cove seals. This recessed portion of the shuttle's wing harboring the elevon nose also had seals to prevent high temperature gas from entering the wing structure. The FLL built the structure and demonstrated that the elevon cove seals worked properly.

Keywords:

Elevon cove; Rockwell International; Shuttle side door vents; Dennis Jenkins; Columbia; Christopher C. Kraft, Jr.

NASA's shuttle program was concerned early on about the orbiter's ability to handle the stresses of atmospheric re-entry: no previous exo-atmospheric vehicle had spent as long in the re-entry phase of flight as would the space shuttle. While the X-15 flew into space, its entire flight never lasted longer than about 12 minutes—much more typically between 10 and 11 minutes—little of which was actually spent on re-entry, and it never reached the altitudes of Mercury or subsequent capsules. Capsules returned to Earth on a quasi-ballistic trajectory, passing relatively quickly into the atmosphere, and managed this feat through the use of ablative material which neither the X-15s nor the space shuttle orbiter carried (save the five first shuttle flights, which did carry some ablation material).²⁶¹ The shuttle's flight profile and its typical low Earth orbit (LEO) altitude, meant that entry into the Earth's atmosphere was much more gradual than that of any capsule. This was because the shuttle had wings, and at a certain point in its entry trajectory dynamic pressure would make those wings functional. Of course, the shuttle also would need to endure enormous heat for a considerable length of time, making both heat and structural loads real concerns. Moreover, this was the first use of a new thermal protection system (TPS) on a scale this large - one that had to undergo lengthy re-entry. That alone was cause for concern.

In 1979, two years before the shuttle first flew into space, the Center's Flight Loads Laboratory (FLL) began various experiments related to the space shuttle program. One of the earliest experiments involved a shuttle outboard wing section and a complete elevon, which were subjected to a combined heating and loads test. Rockwell, the shuttle's primary contractor, came to the Center with the structure because of Laboratory's testing abilities, recalled Loads Lab engineer Walter Sefic.²⁶² There were two tests: heating the aluminum sub-structure, and the elevon seals themselves. "The primary purpose of these tests was to verify the functional capability of a system of seals between the wing and the elevon."²⁶³

The orbiter had primary and secondary seals on the elevons to prevent hot gas from entering the elevon cove and wing structure. As early as 1977 the Agency had expressed concern about the elevon cove seals' ability to withstand the heated gas during re-entry, and the resulting potential damage to the wing. "The wing elevons are fitted with gas seals that allow free movement of the elevons while reducing the flow of high enthalpy gases through the internal structure," wrote three JSC investigators. "The failure of these seals is difficult to predict analytically."²⁶⁴ Another report noted: "excessive leakage of the elevon seals can result in overheating

²⁶¹ Dennis Jenkins, note to Christian Gelzer.

²⁶² Walter J. Sefic, interviewed by Christian Gelzer May 21, 2014, in the NASA Armstrong Flight Research Center Oral History Collection. Members of the Flight Loads Laboratory that worked on the elevon seal test received a NASA Group Achievement Award for their work in 1979 ("Elevon Seals Systems Structural Test Team Group Achievement Award," November 15, 1979).

²⁶³ Roger A. Fields, *Flight Vehicle Thermal Testing with Infrared Lamps*, NASA TM 4336, (Edwards, CA: NASA Dryden Flight Research Facility, 1992), p. 4.

²⁶⁴ Carl D. Scott, Linus P. Murray, and James Milhoan, "Shuttle Elevon Cove Aerodynamic Heating by Internal Flow," (77-757) presented at the 12th AIAA Thermophysics Conference, Albuquerque, NM, June 27-29, 1977, p. 2. This test used an arc jet to evaluate the seals' effectiveness as well as examine the possible consequences of high temperature gas leaks. "The flow of high enthalpy gases," notes aerospace engineer William Guoan, equals "energy in a thermodynamics system." William T. Guoan email correspondence with Christian Gelzer, January 30, 2017.

the wing or elevon structure.”²⁶⁵ Aaron Cohen, Orbiter Project Manager at JSC, requested the tests: he also arranged the funding.²⁶⁶

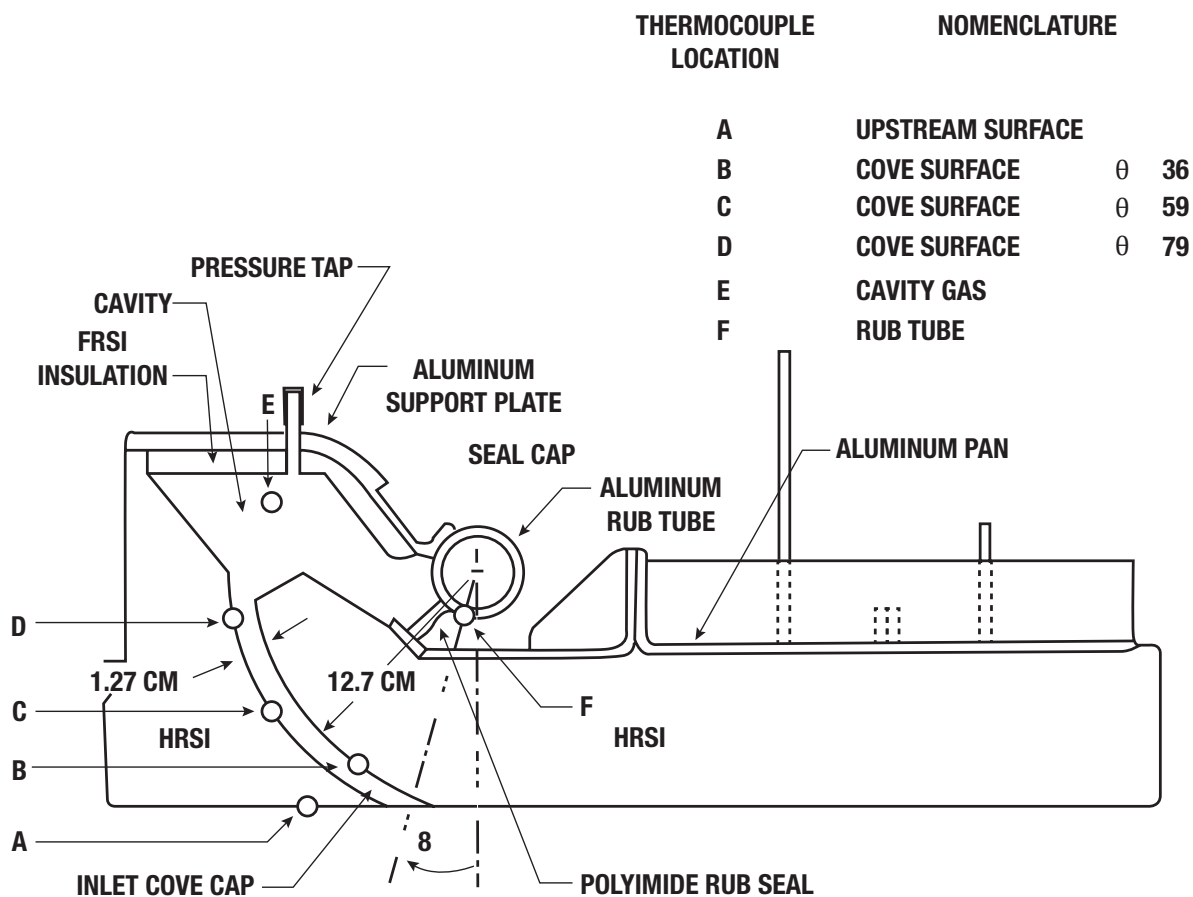

Test article cross section showing thermocouple locations and nomenclature (AIAA 77-757, fig. 1).

“The test [at the Flight Research Center] primarily consisted of applying simulated environments from engineering projected heat zones, loads, deflections and pressures encountered during ascent and descent of the Shuttle Vehicle,” recalled Rockwell Research Test Engineer Henry “Hank” Freitag.²⁶⁷ The FLL at the Center had, by then, established a national reputation for its ability to perform thermodynamic load testing on very large structures and at very high temperatures. In 1969 the Laboratory set up and tested an entire Lockheed YF 12, covering it top and bottom with quartz radiant heat lamps (raising portions of the aircraft to nearly 600 degrees Fahrenheit (315 C) and maintaining it for hours on end) while applying aerodynamic loads to the structure—inside the Laboratory’s hangar.²⁶⁸ The FLL engineers performed the very first tests of a reusable hypersonic vehicle, the X-15, in the 1960s, and learned the art of cooling a surface or material to flight temperatures - easily -50 degrees Fahrenheit (-45.5 degrees C) - and within seconds heating it to hundreds of degrees, all the while applying aerodynamic and elastic loads to the structure. “We started doing some small thermal research work with Langley on TPS,” recalled Larry Hudson. “We were the larger

²⁶⁵ “Project Document, January 23, 1978,” “Elevon Seals System Test,” PD 78-8, NASA Ames/Dryden Flight Research Center, 1978.

²⁶⁶ Both the Air Force’s Arnold Engineering Development Center, (AEDC) in Tullahoma, TN, and Langley conducted subsequent tests on the gap because “heating between the gaps was of great concern,” narrowing the gap between the “stub” and the elevon. D. W. Stallings, *Wind Tunnel Tests of Elevon Gap Heating on the Space Shuttle Orbiter*, (OH-107) AEDC-TSR-81-V7, (Tullahoma, TN: Arnold Air Force Station, 1981), p. 4, and L. Roane Hunt, *Aerodynamic Pressures and Heating Rates on Surfaces Between Split Elevons at Mach 6.6*, NASA TP 2855, (Langley, VA: NASA Langley Research Center, 1988), p. 1. Langley’s report did not focus solely on the shuttle, but looked at hypersonic vehicles in general. The report refers coyly to a need to study control surfaces of re-entry vehicles “such as the shuttle.” At the time the only other hypersonic re-entry vehicle receiving considerable attention was the National Aero-Space Plane, or NASP.

²⁶⁷ Hank Freitag, email to Christian Gelzer, April 28, 2015.

²⁶⁸ Jerald M. Jenkins and Robert D. Quinn, *A Historical Perspective of the YF-12A Thermal Loads and Structures Program*, NASA TM 104317, (Edwards, CA: NASA Dryden Flight Research Center, 1996), pp. 1-2.

structure testing facility, Langley was doing the sub-element work, the coupon level work, and we were doing the bigger pieces in our Laboratory because we had the capability.”²⁶⁹

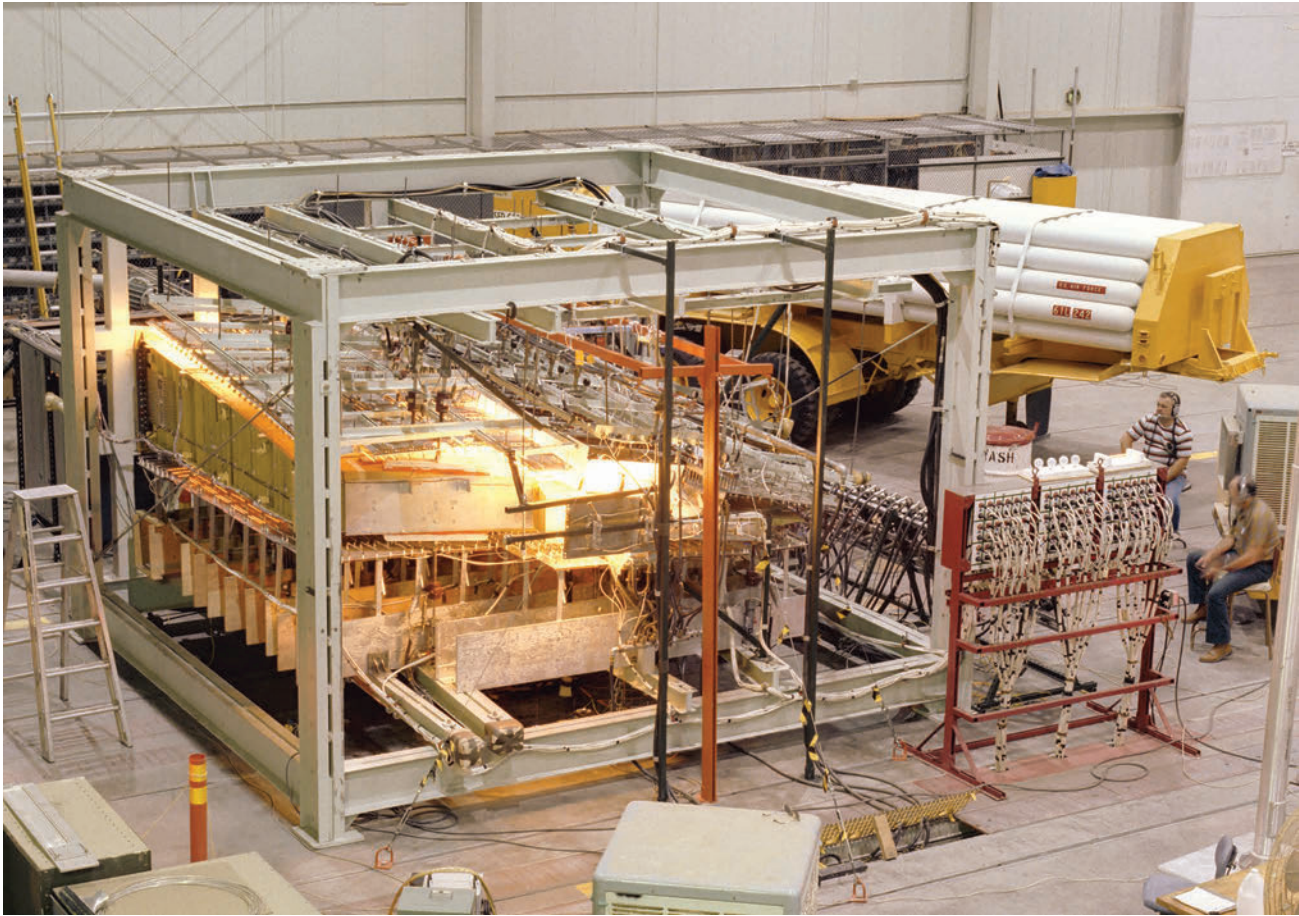

Combined heating, loading, and pressurization test of the shuttle wing section, including elevon and elevon cove. EC79-11287

Rockwell provided the test article (an orbiter wing stub) and prepared the final Engineering Analysis Report.²⁷⁰ The elevons had a double seal to keep hot gases from entering the cavity between the wing and the elevon cove. Passage of freestream air beyond the seals could overheat the aluminum substructure in that region, which could be catastrophic to the orbiter.²⁷¹ To conduct the test the wing stub was cantilevered, after which hydraulic actuators were attached to the elevon via load pads. Quartz lamps then were added in order to raise the temperature of the surface to hypersonic temperatures, replicating re-entry heat. Once heated, the hydraulic system exercised the elevon. The test took place in a large steel-framed box with forced nitrogen in the test area to pressurize the seal area, and was completed by September 1979, four months ahead of schedule. Christopher C. Kraft, Jr., JSC Center Director at the time, sent a letter of appreciation to the Facility Director, Isaac Gillam, commending the Flight Loads Research Facility’s staff (as the Laboratory was then called) for their “outstanding...flexibility and willingness to adjust to the test requirements” enabling the contractor “to obtain excellent data in a timely manner.”²⁷²

²⁶⁹ Larry Hudson, interviewed by Christian Gelzer and Jay Levine, June 13, 2014, in the NASA Armstrong Flight Research Center Oral History Collection.

²⁷⁰ “Management Plan: Orbiter Elevon Seals System Test Program at DFRC,” Spacecraft Design Division, Mechanisms Branch, Johnson Space Center, [n.d.], “Elevon Seals System Test,” PD 78-8, NASA Ames/Dryden Flight Research Center, 1978. Marginalia in this report from February 2, 1978, by Gerald Jenkins indicates concern over which entity was responsible for the final report: “Aero-Structures does not have adequate manpower to support that effort.”

²⁷¹ Scott, Murray and Milhoan, “Shuttle Elevon Cove Aerodynamic Heating by Internal Flow.”

²⁷² Roger A. Fields, *Flight Vehicle Thermal Testing with Infrared Lamps*, pp. 4, 23; also presented at the Structural Testing Technology at High Temperature Conference, Dayton, OH, November 4-6, 1991. Because NASA performed the work at Rockwell’s request, members in the Laboratory generated no formal report about the test. “Support Requirement Check-List, p. 3” in “Project Document

The Laboratory went on to generate a great number of orbiter related reports over the next two-and-one-half decades and performed research on projects that were not themselves directly related to thermal or stress analysis of the orbiters but were still critical to the shuttle program itself.²⁷³ Engineers Leslie Gong, Robert Quinn, and William Ko issued a report on re-entry heating of the space shuttle using flight data analysis, for instance, examining heating rates at several areas on the orbiter's wings and fuselage.²⁷⁴ Ko authored a report on the resilience of the TPS at several locations on the orbiter when subjected to debris at high speeds.²⁷⁵ During Columbia's first ferry flight across the U.S. by the shuttle carrier aircraft a number of TPS tiles and gap fillers either dislodged or "migrated." Neither was supposed to happen; engineers at the Johnson Space Center (JSC) wanted to know the cause, particularly since the orbiter had not been subjected to high air loads on its trip. The missing and "migrated" tiles led to questions about the integrity of the TPS, especially under the duress of launch and atmospheric re-entry. JSC selected the Flight Research Center as the site for flight tests of both tiles and attaching materials, because it alone among all the NASA Centers operated Mach 2 aircraft (F-15s) capable of approximating the loads which the space shuttle would encounter on liftoff.

Tiles representing different areas of concern on the orbiter were bonded to areas on the one of the Center's F-15s, which was then flown at precise speeds and angles of attack to closely match the dynamic loads endured by the shuttle during ascent (but not the time histories of the flights).²⁷⁶ There was concern at the Center about the consequence of a tile's impact on the F-15, should one dislodge from the aircraft in flight and strike a vertical stabilizer. Engineers looked at direct and oblique impacts and concluded that "the tile breaks immediately after impact ... the impact force exerted on the leading edge of the vertical stabilizer is relatively low. After impact, the broken tile pieces continue to travel at a velocity very close to the original before impact."²⁷⁷

Once the Shuttle Program was satisfied that the orbiters could sustain the effects of re-entry, it wanted to know about residual heat following landing, and again, it turned to the Center for answers. Using the Structural Performance and Resizing Program (SPAR) to analyze heat transfer and internal radiation, one mid-fuselage cross section and one mid-span wing segment were analyzed. Ko, Quinn, and Gong found that internal convection was more "prominent" than mere radiation and that "calculated structural temperatures at certain stations could be as much as 45-90% higher than the measured values."²⁷⁸

Preliminary analysis showed good correlation between predicted internal wing temperatures and actual temperatures of the orbiter when it came to the TPS, but this fell apart when it came to the substructure of the orbiter and area beneath the wing skins, particularly following touchdown. Center engineers undertook the study to better correlate instrumentation data with the tools in order to hone the tools themselves. Trying to account for the temperature spikes the engineers registered, Rockwell explained that there were air vents near the wing roots that opened to allow external air to circulate within the wing box and substructure, providing convective cooling. These vents sometimes opened while the orbiter was still at an altitude of 100,000 feet (30.48 km).

January 23, 1978," See also Letter from Christopher C. Kraft, Jr. to Isaac T. Gillam, Director Hugh L. Dryden Flight Research Center, October 17, 1979. "Elevon Seals System Test," PD 78-8, NASA Ames/Dryden Flight Research Center, 1978. Kraft served as Flight Director for virtually all the early NASA spaceflights and in 1972 assumed the position of Center Director of the Manned Spacecraft Center - today's JSC.

²⁷³ Consider, for example, the Laboratory personnel's work on the Convair CV-990 Landing Systems Research Aircraft, which the Center extensively modified to carry a structure that could extend a shuttle tire onto a runway and subject it to crosswind forces and different surfaces to gauge tire wear. The CV-990 modification included cutting the aircraft's keel and building a new internal structure. This work and more had to be evaluated by Laboratory personnel before and after, prior to the CV-990 resuming flights. John F. Carter and Christopher J. Nagy, *The NASA Landing Gear Test Airplane*, NASA TM-4703, (Edwards, CA: NASA Dryden Flight Research Center, 1995).

²⁷⁴ Leslie Gong, Robert D. Quinn, and William L. Ko, *Reentry Heating Analysis of Space Shuttle with Comparison of Flight Data*, NASA CP-2216, in *Computational Aspects of Heat Transfer in Structures*, (Langley, VA: NASA Langley Research Center, 1982), pp. 271-294.

²⁷⁵ William L. Ko, *Impacts of Space Shuttle Thermal Protection System Tile on an F-15 Aircraft Vertical Tail*, NASA TM 85904 (Edwards, CA: Dryden Flight Research Facility, 1985), p. 1.

²⁷⁶ Robert R. Meyer, Jr., Calvin R. Jarvis, and Jack Barneburg, *In-Flight Aerodynamic Load Testing of the Shuttle Thermal Protection System*, AIAA-81-2468 Report, November 11, 1981.

²⁷⁷ Ko, *Impacts of Space Shuttle Thermal Protection System Tile on an F-15*. p. 15.

²⁷⁸ William L. Ko, Robert D. Quinn, and Leslie Gong, *Effects of Internal Convection and Internal Radiation on the Structural Temperatures of Space Shuttle Orbiter*, NASA TM 100414, (Edwards, CA: NASA Dryden Flight Research Facility, 1988), p. 1.

“The vent doors were on the sides of the fuselage...nine per side,” noted shuttle engineer and historian Dennis Jenkins. “Early in the program, engineers determined doors 3, 5, and 6 provided sufficient venting of the payload bay and mid-fuselage, so they permanently disabled doors 4 and 7 on both sides of OV-102 and OV-104, and on OV-103 before STS-60. The associated actuators and linkages were also removed. Rockwell did not install the equipment on OV-105, although provisions existed to activate the doors if required (this was never done). All compartments formerly vented by vent 7 (wing, wing glove, and main gear wheel well) were vented through internal ducts into the payload bay.”²⁷⁹

As for the elevon cove, Center engineers discovered errors made in calculating the free convection heat transfer coefficients—which turned out to be much lower than the true values. Correcting for the differences, the engineers concluded that the “major mode of internal convective heat transfer was free convective, as initially deduced.”²⁸⁰ In the end the elevon cove was left as it was, although other areas of the wing were redesigned for different reasons. Work performed at the Center Flight Loads Laboratory was crucial in establishing the control systems of the space shuttle orbiter as suitable for re-entry; it proved to be the first of many shuttle-related tests the Laboratory performed over the decades.

²⁷⁹ Dennis R. Jenkins, email correspondence with Christian Gelzer, March 24, 2014, citing “Mechanical, Maintenance, Arm & Crew Systems (MMACS) Console Handbook,” Volume IV: Mechanisms, JSC-28922, April 1, 2007.

²⁸⁰ Ko, Quinn, and Gong, *Effects of Internal Convection and Internal Radiation on the Structural Temperatures of Space Shuttle*, p. 2.

8: Early Shuttle Thermal Protection System Tests on F-104 and F-15 Testbed Aircraft

Gray Creech
Jacobs Technology, Inc.
NASA Armstrong Flight Research Center

Abstract:

Following the loss of thermal protection system tiles on the space shuttle orbiter during its first cross-country piggyback flight, the Shuttle Program Office asked the AFRC to conduct a series of tests of different tiles using two supersonic aircraft. Flown on an F-104 and an F-15, tiles from different areas on the orbiter were subjected to realistic aerodynamic loads to determine resiliency. The information gained from this testing led to modifications in some cases, and, when serendipity allowed the Center pilots to fly in rain, to specific rules governing cross country flight of the orbiter.

Keywords:

Thermal Protection System; F-104; F-15; Flight Test Fixture; Rain erosion

Theodore von Kármán once remarked: “Re-entry is perhaps one of the most difficult problems one can imagine.”²⁸¹ All of the energy imparted to a spacecraft from its stationary position to low Earth orbit—reaching at least Mach 17 and 50 mi. altitude (80 km)—becomes kinetic and potential energy that is scrubbed off through atmospheric friction in order to decelerate and return to a landing. As researchers at Ames demonstrated, shapes made profound differences in whether or not an object or spacecraft survived re-entry. If shapes were the first piece of the puzzle, materials were the second.²⁸²

There are different ways to deal with the incredible heat encountered on re-entry, ranging from hot structures to insulation. “The division of TPS [thermal protection systems] is somewhat arbitrary and not universally accepted,” admitted NASA engineer Tim Risch, but it typically breaks down accordingly:

- Passive: insulators (multi-use) and ablatives (one-time use)
- Semi-Passive: heat pipes moving fluids using surface tension (no mechanical energy input)
- Active: heat exchangers using external pumps (requiring energy input), and transpiration²⁸³

Passive TPS comes in several forms: insulation to protect a substructure that cannot handle the extraordinary temperatures, ablatives that sublime or char during re-entry to both insulate and carry away heat, a heat sink that absorbs moderate heat and releases it gradually after the temperature spike (good for short duration heat fluxes), and hot structures, similar to heat sinks but suited for higher, long duration heat fluxes.²⁸⁴ An active TPS “supplies coolant to continually remove heat or to block the heat from reaching the structure.”²⁸⁵ This is done with radiators or by expelling a liquid through a porous material as an evaporative coolant (transpiration). To date, excepting experiments, only passive TPS have been used by the U.S. so we will dwell only on this method.²⁸⁶

²⁸¹ Theodore von Kármán, “Aerodynamic Heating: The Temperature Barrier in Aeronautics,” *High Temperature Symposium*, June 25-27, 1956, University of California Berkeley, 1956, in David K. Stumpf, *Titan II: A History of a Cold War Missile Program*, foreword by Lt. Gen. Jay W. Kelley, Ret., (Fayetteville: University of Arkansas Press, 2000), p. 56.

²⁸² Of the early German A4 test launches to a land target (Blizna, Poland), the overwhelming majority (22 of 26) broke up on re-entry, something German engineers could not explain. Von Braun thought he might determine the cause by watching a returning missile in the final phase and planted himself close to where he expected the impact to be. He was much closer than he expected, it turned out, but observed nothing to solve the problem. Dennis Piszkiwicz, *The Nazi Rocketeers: Dreams of Space and War Crimes*, (Mechanicsburg, PA: Stackpole Books, 1995), p. 145. See also Sayed Ramsey, *Tools of War: History of Weapons in Modern Times*, (Alpha Editions, 2016).

²⁸³ Tim Risch, email to Christian Gelzer, November 3, 2016.

²⁸⁴ Satish Kumar Bapanapalli, “Design of an Integral Thermal Protection System for Future Space Vehicles,” Ph.D. Dissertation, University of Florida, 2007, pp. 24-29.

²⁸⁵ Mohamed S. Aly-Hassan, “A New Perspective in Multifunctional Composite Materials,” in Klaus Friedrich and Ulf Breuer, eds. *Multifunctionality of Polymer Composites: Challenges and New Solutions*, (Amsterdam: Elsevier, 2015), p. 58. See also Frances I. Hurwitz, *Thermal Protection Systems (TPS)*, https://www.researchgate.net/publication/230293975_Thermal_Protection_Systems_TPSs, accessed November 28, 2016.

²⁸⁶ For a discussion of transpiration’s experimental use and potential see Hannah Böhrk, *Transpiration Cooling at Hypersonic Flight—AKTiV on SHEFEX II*, 11th Annual AIAA/ASME Joint Thermophysics and Heat Transfer Conference, paper 2014-2676, Atlanta, GA, June 16-20, 2014; and Thomas Reimer, Markus Kuhn, Ali Gülhan, Burkhard Esser, Martin Sippel, and Arnold van Foreest, *Transpiration Cooling Tests of Porous CMC in Hypersonic Flow*, 17th AIAA Space Planes and Hypersonic Systems and Technologies

Spacecraft employ one of two structures: “hot” or “cold.” Hot structures comprising exotic alloys act as the load-carrying structure while absorbing very high temperatures. The X-15, for example, was a hot structure that used Inconel-X® to deal with high temperatures of brief duration. Inconel-X® is dense and heavy and retains its tensile strength to 1,000 degrees Fahrenheit (538 degrees C) and above. (Inconel® has been used for rocket motor thrust chambers.) Other varieties of hot structures can carry much higher temperatures.²⁸⁷

Cold structures carry structural loads only at low temperature (such structures are much lighter as a result) and must be protected from enormous heat by an external coating of some sort.²⁸⁸ Enter different kinds of insulation. American space capsules used ablatives - materials that charred or sublimated during atmospheric entry to carry away the enormous heat. The space shuttle orbiter was a cold structure and, given its size, needed a reusable and lightweight TPS. This need led to the creation of several different materials for thermal protection on the orbiter, determined by peak thermal loads at specific locations. The material chosen for the principal shuttle TPS derived from work with silica/alumina fibrous tiles by Lockheed Missile and Space Co., Sunnyvale, CA, in the late 1950s and early 1960s. The same company made the majority of these tiles for the shuttle.²⁸⁹ Places where temperatures would be the most extreme—the nose and wing leading edges—were made of reinforced carbon-carbon (RCC). RCC is a carbon graphite composite fabric “impregnated with phenolic resin [that] is laid-up in complex shaped molds and cured. The resin polymer is converted to carbon by pyrolysis [and] is impregnated with furfuryl alcohol and pyrolyzed three more times to increase its density with improvement in its mechanical properties. The resulting part is a hard carbon structure possessing reasonable strength and low coefficient of thermal expansion: excellent resistance to thermal extremes and shock.”²⁹⁰ Elsewhere thermal blankets sufficed.

Peak temperatures on the surface of the orbiter’s fuselage during its return through the Earth’s atmosphere ranged between 1,200 and 2,300 degrees Fahrenheit (649 and 1,260 C), with the wing leading edges enduring 2,800 degrees Fahrenheit (1,538 C) or higher.²⁹¹ (The shuttle’s cockpit windows had to endure temperature swings of 500 degrees Fahrenheit.) For the highest-heat areas of the orbiter fuselage NASA used small, low density, ceramic-coated silica tiles individually bonded to the orbiter’s aluminum substructure. Each tile, approximately thirty-six-inches square, was attached to a Nomex®-felt strain isolation pad (SIP), which itself was attached to the aluminum substructure. All the tiles were separated from adjacent tiles by small gaps that allowed for thermal expansion. Some of the gaps in the highest temperature areas were filled with ceramic-coated alumina mat gap fillers to prevent hot gases from seeping into the gaps and reaching the orbiter’s structure. The RCC did its work through high emissivity.

Columbia, the first spacebound space shuttle, came to the Flight Research Center by truck from its assembly site at the Rockwell International facility in Palmdale, CA some 35 miles (56.3 km) away. After being mounted on the back of the NASA Boeing 747-100 shuttle carrier aircraft (SCA) by way of the mate-demate-device, the orbiter was flown from the Center to the Kennedy Space Center (KSC) in Florida.²⁹²

During that first ferry flight some of the tiles and gap fillers in certain areas of Columbia departed the orbiter (“migrated,” the engineers said).²⁹³ This was unexpected, especially given the modest flight conditions and air

Conference, April 11-14, 2011, San Francisco, CA, paper 2011-2251.

²⁸⁷ <http://www.spacelaunchreport.com/falcon9.html>, accessed October 20, 2016.

²⁸⁸ Roger A. Fields, Lawrence F. Reardon, and William H. Siegel, *Loading Tests of a Wing Structure for a Hypersonic Aircraft*, NASA TP-1596, (Edwards, CA: NASA Dryden Flight Research Center, 1980), 1.

²⁸⁹ Rodriguez and Snapp, “Orbiter Protection System,” *Wings in Orbit*, p. 185. Comprising 99.7 percent pure silica fiber, the shuttle tiles had a remarkably low heat transfer rate: “a piece of material can be held by the edges with a bare hand only seconds after being removed from an extremely hot oven.” The tiles’ outward facing black surface had 90 percent emissivity. “Space Shuttle High-Temperature Reusable Surface Insulation (HRSI),” (Lockheed Missile & Space Company, 1982), pp. 1-2.

²⁹⁰ Donald M. Curry, John W. Latchem, and Garland B. Whisenhut, “Space Shuttle Orbiter Leading Edge Structural Subsystem Development,” AIAA 21st Aerospace Sciences Meeting, January 10-13, 1983, Reno, NV, AIAA 83 0483. See also, <https://spaceflight.nasa.gov/shuttle/reference/shutref/orbiter/tps/carbon.html>, accessed January 2, 2018, and Gail Chapline, Alvaro Rodriguez, Cooper Snapp, Myron Pessin, Paul Bauer, Bruce Steinezt, Charles Stevenson, Charles Stevenson, “Thermal Protection System,” in *Wings in Orbit: Scientific and Engineering Legacies of the Space Shuttle*, ed. Helen Lane, (Washington, D.C.: NASA, 2001), p. 187, https://www.nasa.gov/centers/johnson/pdf/584728main_Wings-ch4b-pgs182-199.pdf, accessed June 8, 2018

²⁹¹ *Columbia Accident Investigation Board Report*, Volume 1, August 26, 2003, and http://www.centennialofflight.gov/essay/Evolution_of_Technology/TPS/Tech41.htm, accessed February 13, 2012.

²⁹² There were two permanent mate-demate-devices (MDDs) built: one at the Flight Research Center, the other at KSC. Their purpose was to lift the orbiters high enough into the air for the 747-100 shuttle carrier aircraft (SCA) to be rolled in beneath, and then lower the orbiter down for attachment to the SCA. The reverse process, removing the orbiter from the SCA, took place at KSC.

²⁹³ Robert R. Meyer, Jr, interviewed by Gray Creech, January 19, 2012.

loads. Principally as a result of the first SCA piggyback ferry flight of Columbia from California to Florida, engineers concluded that the air loads on the orbiter's TPS tiles would be higher than expected during both ascent and descent through the atmosphere, and needed further study. And so, engineers from the Johnson Space Center (JSC) Shuttle Program Office began reassessing the effects of air loads on the shuttle's thermal protection system during flight through the atmosphere.²⁹⁴

Following its reassessment, the Shuttle Program Office laid out a plan for additional wind-tunnel tests and in-flight aerodynamic loads testing of TPS specimens from six areas of the orbiter subject to the highest air loads. They selected the Flight Research Center F-104G and F-15A testbed aircraft to carry the in-flight experiments, the Center having the Agency's only suitable platforms for such high-speed work. "The F-104/FTF [Flight Test Fixture] has some unique operational capabilities [when compared to] wind tunnels," wrote Robert "Bob" Meyer, Jr. "These include a larger Mach number, Reynolds number, and dynamic pressure envelope than most wind tunnels or full-scale test articles. Additionally, data can be obtained on the FTF near and through a Mach number of 1.0 with little or no adverse effects."²⁹⁵ Obtaining transonic and supersonic data was central to this effort. Meyer noted that supersonic wind tunnels, such as the Ames 11-foot (3.35 m) transonic tunnel, had "a slightly higher maximum dynamic pressure capability in the wind tunnel, but for a much smaller range of Mach number." Being able to gather data over a greater range was important, and the team found they could match or exceed the necessary aerodynamic pressure for most of the tests. Moreover, when full-scale articles such as those the Center was asked to analyze were placed in wind tunnels for similar tests, "the launch profile dynamic pressures were not achieved because the large size of the test articles severely blocked the wind tunnel circuit."²⁹⁶

Calvin R. "Cal" Jarvis served as project manager as the effort coalesced from very loosely-defined needs expressed by shuttle program engineering into a manageable, achievable project with clearly defined goals and objectives under the Flight Research Center's expertise.²⁹⁷ Jarvis worked on the Lunar Landing Research Vehicle and then the Vought F-8 Digital Fly-By-Wire program and had considerable project experience by then. But things did not start out smoothly. Still early in his career at the Center at the time, Meyer was assigned as the project's chief engineer. "I remember that first meeting with the Johnson shuttle engineers," he recalled. "One at a time, our guys were getting up and leaving the room, frustrated because the Johnson engineers didn't know what they wanted. I stayed for the rest of that first meeting, and, over several more meetings we finally came to a consensus on what the Shuttle Program Office actually needed in regards to data for this TPS reassessment."²⁹⁸

JSC engineers wanted an examination of the TPS from six locations on the orbiter: the wing glove; a group of tiles called "close out" tiles that sat behind the RCC on the wing's leading edge and transitioned to "acreege tiles" that spread over the upper wing; the vertical stabilizer leading edge; the window post (called "J-tiles"); the elevon cove, a narrow, convex area at the wing-to-elevon junction; and the elevon trailing edge. The test articles were mounted on the testbed aircraft to simulate the outer mold lines of the spot on the orbiter being tested, and production TPS tiles were used in the tests; any differences that might have existed were not believed significant.²⁹⁹ The Shuttle Program Office chose these six areas because they were subject to high air loads and high pressure gradients.³⁰⁰

"The objectives of the project were to verify the predicted air loads acting on the tile and gap-filler system using pressure measurements, and to demonstrate the performance of the tile and gap-filler system at dynamic pressures up to 1.4 times the design value." The tests did not include the effects of the rocket-boosted orbiter's vibration-acoustic environment, thermal environment, or out-of-plane deflections during ascent to orbit.³⁰¹ "As I recall, the test pilots really enjoyed this program. They enjoyed flying some really odd flight

²⁹⁴ Robert R. Meyer, Jr., Calvin R. Jarvis, and Jack Barneburg, *In-Flight Aerodynamic Load Testing of the Shuttle Thermal Protection System*, AIAA-81-2468 report, November 11, 1981.

²⁹⁵ Meyer, Jarvis, and Barneburg, *In-Flight Aerodynamic Load Testing of the Shuttle Thermal Protection System*, and Robert R. Meyer, Jr., *A Unique Flight Test Facility: Description and Results*, NASA TM 84900, (Edwards, CA: NASA Ames-Dryden Flight Research Facility, 1982), 5. See also Meyer, Jr., interviewed by Creech.

²⁹⁶ Meyer, Jr., *A Unique Flight Test Facility*, p. 4.

²⁹⁷ Meyer, Jr., interviewed by Creech.

²⁹⁸ Meyer, Jr., interviewed by Creech.

²⁹⁹ Meyer, Jr., interviewed by Creech; and Meyer, Jarvis, and Barneburg, *In-Flight Aerodynamic Load Testing of the Shuttle Thermal Protection System*.

³⁰⁰ "Air loads" refers to aerodynamic forces on the shuttle.

³⁰¹ Meyer, Jarvis, and Barneburg, *In-Flight Aerodynamic Load Testing of the Shuttle Thermal Protection System*, p. 1.



The F-15B's right wing layered with shuttle tiles for flight. NASA EC80-12253

profiles to reach the local qs we were trying to replicate over the test articles. For one F-15 flight test, he had to fly supersonic upside down!”³⁰²

Engineers believed that by reproducing orbiter geometry and pressure flow fields, the test article's tiles, gaps, and subsurface support structure would undergo aerodynamic pressure loads closely matching those that would occur on the orbiter during launch or re-entry.³⁰³ The engineers and technicians worked hard to build duplicates of the relevant locations on the orbiter for each test. Despite this, accurately characterizing the external flow field that was expected over and around each relevant section of the orbiter was sometimes

When running, rocket engines (solid and liquid) generate enormous vibrations that “come in the form of waves, which travel up and down the length of the rocket like a musical note through an organ pipe.” Examination of Columbia after STS-1 revealed 14 heat shield tiles destroyed and another 148 damaged by acoustic vibration. Liquid rockets generate waves that “couple structure and propulsion instability,” dubbed the “pogo effect” after the children’s jumping toy. Astronaut Mike Collins said of the early Titan II boosters on which the Gemini capsules rode: “The first stage vibrated longitudinally, so that someone riding on it would be bounced up and down as if on a pogo stick. The vibration was at a relatively high frequency, about 11 cycles per second, with an amplitude of plus or minus 5 gs in the worst case.” NASA insisted on a limit of +/- .25 g and work by several companies reduced the propellant pump cavitation that caused the pogo effect. Despite the fixes, the phenomenon continued, albeit to a lesser degree. “The Gemini V crew of Gordon Cooper and Pete Conrad reported objectionable pogo during launch.” Neither astronaut could read the instrument gages and both had difficulty communicating with Mission Control during the episode. The vibrations on some of the Apollo launches (Saturn V) were also severe. Brittany Sauser, “What’s the Deal with Rocket Vibrations?” *MIT Technology Review*, July 15, 2009, <https://www.technologyreview.com/s/414364/whats-the-deal-with-rocket-vibrations/>, accessed November 3, 2016, Michael Collins, *Liftoff: The Story of America’s Adventure in Space*, (New York: Grove Press, 1988), Curtis E. Larsen, *Experience with Pogo in Human Spaceflight Vehicles*, NASA Johnson Space Center, <https://ntrs.nasa.gov/archive/nasa/casi.ntrs.nasa.gov/20080018689.pdf>, accessed November 7, 2016, and <https://metinmediamath.wordpress.com/2013/12/01/space-shuttle-launch-and-sound-suppression/>, accessed November 3, 2016.

³⁰² Jenkins, email correspondence with Gelzer, April 14, 2015.

³⁰³ The plan was to test at altitudes varying from 12,200 feet to 31,200 feet. Flight Request. Series: 961 to 990. September 5, 1985. Roy Bryant Collection, L5-5-3C, NASA AFRC Historical Reference Collection.

difficult. Wind tunnel data obtained using small models of the orbiter were originally used to predict the details of the pressure distribution on the full-scale orbiter TPS, but this method had several problems:

- wind tunnel data were taken at limited Mach numbers and did not necessarily include the conditions at which maximum air loads would occur;
- pressure orifices on the wind tunnel models were usually too few to accurately predict the details of the pressure distribution on the full-scale vehicle;
- scaling effects made it difficult to predict the details of the pressure distributions in such areas as the trailing edge of the elevon; and
- virtually no wind-tunnel boundary-layer thickness data were available.³⁰⁴

Indeed, reliance on the wind tunnel model data—and only on these data—concluded JSC engineers, led to assumptions about the capabilities of the space shuttle orbiter that contributed to the migration and loss of tile and gap material during that first ferry flight. They believed that for the actual flight-testing of those six high-air-loads areas, the air loads imposed by the boundary layer of the testbed aircraft would be at least as great as the air loads imposed by the orbiter boundary layer. Where to locate the test articles on the testbed aircraft was based on where the boundary layer thickness was believed to be equal to, or thinner than the analogous location on the orbiter.³⁰⁵ After choosing the location of a given test article on the F-104 and F-15 aircraft, Center engineers had pilots make flow field pressure survey flights before each of the test articles was installed.³⁰⁶ These flights were to determine how closely the local flow field, and particularly the pressure gradients for the candidate areas on the testbed aircraft, matched the local conditions believed to exist on the orbiter.

When possible, engineers placed orifice tubes placed in clusters at key locations to take pressure measurements to best document the flow field. These flexible vinyl tubes were mounted externally to gather air pressure distribution data over the test article's proposed location on the aircraft; tubes were used instead of the typical flush-mounted pressure orifices because the tubes were substantially less expensive and, being externally mounted, were simpler to install, particularly in some difficult locations. Moreover, the F-15 had wet-wing fuel tanks, eliminating the options of skin, structural instrumentation, or wiring pass-through.³⁰⁷ After ascertaining proper locations for the test articles intended for each aircraft, the next step was to build and mount the relevant cluster of tiles for each test—performing only one test at a time on an aircraft.

Unable to insert pressure orifices in the TPS tiles themselves (doing so could skew the resulting data), the engineers extrapolated pressure data by placing the tubes in the gaps between the tiles. When this was inadequate, they built foam and fiberglass mock-ups of the outer mold line of the test article, embedded pressure ports and tubes in them and flew the article to verify the expected external flow field on a particular shape. Thus, the engineers were able to gather the desired pressure gradients and levels, allowing them to determine test article incidence changes or fairing geometry changes.³⁰⁸

The engineers were also after pressure measurements in the gaps between the tiles, as well as at the inner mold line. There, pressure orifices were mounted in the Nomex[®] SIP underneath the tiles. Finally, vibration accelerometers were installed on the test articles.³⁰⁹ All of this took place before STS-1 flew, so the orbiter's actual launch profile was still predicted.

Flight tests of the actual TPS test articles came in two phases. The first phase was a series of calibration flights to measure the inner and outer mold line and gap pressures at low airspeeds (200-250 knots), as well as the accompanying aerodynamic pressures. This approach was to establish an estimate of the air loads on

³⁰⁴ Meyer, Jr., interviewed by Creech; Meyer, Jr., *A Unique Flight Test Facility*.

³⁰⁵ Meyer, Jarvis, and Barneburg, *In-Flight Aerodynamic Load Testing of the Shuttle Thermal Protection System*, p. 1.

³⁰⁶ Meyer, Jarvis, and Barneburg, *In-Flight Aerodynamic Load*, p. 1. See also Meyer, Jr., interviewed by Creech.

³⁰⁷ Meyer, Jarvis, and Barneburg, *In-Flight Aerodynamic Load Testing*; Meyer, interviewed by Gray Creech, and; Lawrence C. Montoya and David P. Lux, *Comparisons of Wing Pressure Distribution from Flight Tests of Flush and External Orifices for Mach Numbers from 0.50 to 0.97*, (Edwards, CA: NASA Flight Research Center, 1975).

³⁰⁸ Meyer, Jarvis, and Barneburg, *In-Flight Aerodynamic Load Testing*, p. 2. The Center performed a series of similar tests later in the orbiter program when data from pressure ports located in the upper wing of Columbia did not agree with derived data. Using the F-104 and the FTF, the team repeated many of the earlier parameters, establishing that “orifice installation adversely affected the pressure measurements” but the affect was not great enough to explain all of the inconsistent data. Timothy R. Moes and Robert R. Meyer, Jr., *In-Flight Investigation of Shuttle Tile Pressure Orifice Installation*, NASA TM 4219, (Edwards, CA: NASA Dryden Flight Research Center, 1990), pp. 1, 6.

³⁰⁹ Meyer, Jarvis, and Barneburg, *In-Flight Aerodynamic Load Testing*.



The leading edge of the F-15B sporting pieces of the shuttle tile. NASA EC80-13386

the tiles and gap fillers before exposing the test articles to higher, realistic air loads.³¹⁰ Data from the first flight phase set the desired flight conditions for the second phase, which consisted of full-bore test flights that followed various projected orbiter Mach number and dynamic pressure launch profiles, at least to the extent possible with the two aircraft. The flight profiles used were the same as those planned for STS-1. The engineers modified the launch profiles for two instances of the tests to avoid high air-load conditions caused by peculiarities in the flow field of a test article. Not doing so would have distorted the resulting data. Telemetry systems on the aircraft made it possible to feed data to a control room in real time at the Center and have some of the data immediately sent back to the testbed. While engineers in Mission Control at the Center monitored Mach number, aerodynamic pressure, and selected pressure gradients in real time, the data sent back to the research pilots helped them avoid inadvertent overpressures on the test articles.

The Flight Research Center used an F-104G fighter jet as one of the testbed aircraft to fly the TPS materials. NASA tail number 826 was one of three F-104Gs acquired from the Luftwaffe in 1975 and it flew a wide variety of tests and experiments for the Center until its retirement in 1994.³¹¹ This airplane was kept busy flying multiple shuttle TPS material samples from different orbiter locations. Each sample had different a shape, introducing varying shockwave geometries and air loads across the test article. How well the TPS materials and their bonding adhesives and gap-filling materials held up to the different aerodynamic pressures remained an unknown until flown on this testbed.

The F-104 flew two of the six test articles. The airplane had been modified to carry a specially designed structure, called the Flight Test Fixture (FTF), mounted on the centerline belly station. This structure made it possible to carry experiments, along with instrumentation the data from which could be telemetered to Mission Control at the Center, sometimes even including a video feed. One of the test specimens was mounted on the aft portion of the FTF, the other was anchored to the trailing edge flap of the left wing.³¹² For the latter tests the trailing edge flaps were locked in a pre-selected position and the boundary layer control

³¹⁰ Meyer, Jarvis, and Barneburg, *In-Flight Aerodynamic Load Testing*.

³¹¹ NASA 826 was the last F-104 NASA flew; the airplane is on static display at AFRC.

³¹² Meyer, Jarvis, and Barneburg, *In-Flight Aerodynamic Load Testing*.

system (bleed air ducts over the flaps) was disabled.³¹³ Fixing the flap with the elevon attached placed the item in the air flow, putting air loads on the tiles in question.

The elevon test article, approximately 20 inches long and 13 inches deep (51 by 33 cm), contained six tiles with three gap fillers and was instrumented with surface pressure orifices, internal static pressure orifices, and vibration accelerometers (it was an articulating piece of the orbiter that moved in and out of the air flow). The test assembly was mounted on the left flap of the F-104 in the center of the span and extended about four inches beyond the flap's trailing edge. "Because of the possibility of flutter of the wing or flap, the mock up and the test article were restricted to less than 25 pounds [11.34 kg]."³¹⁴

Concerned about flutter because of the test article's location and weight—even considering the weight limitation—Center engineers decided to conduct the tests at constant altitude and acceleration rather than at the varying aerodynamic and dynamic pressures called for by the launch profiles. Nevertheless, the pilots managed to subject the specimen to Mach numbers as high as 1.3 and aerodynamic pressures as high as 1,100 psf (4.89kN/.093 m sq)—during the tests, fulfilling the desired test points.³¹⁵ Even though the flight data did not match the projected orbiter data particularly well, the engineers derived valuable results concerning subsurface (SIP) and gap pressures, which they used to verify and modify initial analytical predictions of those parameters. (There was considerable pressure on the Center engineers to extract usable data since the flight tests of the TPS did not exactly follow the shuttle profiles, and shuttle engineers placed heavy emphasis on analysis for certification of the TPS, relying on the data the Center gathered. When they deviated from expected flight profiles it raised concerns. Still, the Shuttle Program Office was satisfied with the results in the end.)³¹⁶

The wing elevon cove test, also flown on the F-104, examined forces in the gap between the trailing edge of the orbiter's wings and the leading edge of the elevons. The test article measured approximately 14 inches by 24 inches (35.5 by 61 cm) and consisted of four tiles and six trailing edge gap fillers. Engineers instrumented the test article with surface flush mounted-static pressure orifices, internal static pressure orifices, and a vibration accelerometer, and mounted it on the rear portion of the FTF. To simulate the elevon deflections of the orbiter, they mounted the test article at a fixed five-degrees-of-deflection into the airstream.³¹⁷

Engineers predicted that the maximum air loads in the elevon cove area would come at Mach 1.1, and the pilots flew standard launch profiles for this experiment. But the data trends (slopes) of the F-104 flight path did not match the space shuttle orbiter design data very well, so the engineers concluded that the test was a poor replication of the actual forces. In this case, they felt the two slopes were the important parameters to match in order to correctly simulate TPS air loads, and only one of the slopes correlated with the expected results. Still, exposure of the test article to the pressure simulations at 1.4 times the design dynamic pressure showed no major deficiencies of the elevon cove TPS, and the engineers concluded that no re-design was needed.³¹⁸

The Flight Research Center also used its first F-15 aircraft (N281NA), an F-15A, as a testbed to fly shuttle TPS coupons. This newer (relative to the F-104) airplane offered an expanded flight envelope for orbiter materials flights in terms of speed, altitude, and payload capability.³¹⁹

The more challenging TPS sample tests were flown by the F-15 since it could better duplicate the space shuttle's ascent trajectory pressure loads than could the F 104. "Two locations were selected on the F-15 as

³¹³ Marta Bohn-Meyer and Fred Jiran, "Techniques for Modifying Airfoils and Fairings on Aircraft Using Foam and Fiberglass," Paper 81-2445, presented at the AIAA, SETP, SFTE, SAE, ITEA, and IEEE 1st Flight Test Conference, Las Vegas, Nevada, November 11-13, 1981, p. 3.

Boundary layer control (BLC) was an important element of the F-104 to lower its very high landing speeds. *With* active BLC the F-104's landing speed was typically 180 knots or more.

³¹⁴ Meyer, Jr., *A Unique Flight Test Facility*, also Bohn-Meyer and Jiran, "Techniques for Modifying Airfoils and Fairings on Aircraft Using Foam and Fiberglass," Paper 81-2445, p. 3.

³¹⁵ The important parameters for this test were the difference between the upper and lower surface pressures, and the relationship of each to the base pressures. Bohn-Meyer and Jiran, "Techniques for Modifying Airfoils and Fairings on Aircraft Using Foam and Fiberglass," Paper 81-2445, p. 3.

³¹⁶ Bohn-Meyer and Jiran, "Techniques for Modifying Airfoils and Fairings on Aircraft Using Foam and Fiberglass."

³¹⁷ Bohn-Meyer and Jiran, "Techniques for Modifying Airfoils and Fairings on Aircraft Using Foam and Fiberglass," p. 3, and Meyer, Jr., interviewed by Creech.

³¹⁸ Meyer, Jr., *A Unique Flight Test Facility*, and Meyer, Jarvis, and Barneburg, *In-Flight Aerodynamic Load Testing*, p. 6.

³¹⁹ Meyer, Jarvis, and Barneburg, *In-Flight Aerodynamic Load Testing of the Shuttle Thermal Protection System*. This F-15A would later serve as the testbed for the Digital Electronic Engine Control system.

areas in which to evaluate four shuttle tile air load tests specimens. The F-15 left wing-fuselage glove...to test representations of the orbiter wing-body glove. The F-15 right wing leading edge at 40% semi-span...to test representations of the orbiter wing leading edge, orbiter vertical stabilizer leading edge, and the orbiter cockpit window post. The stabilizer and the window post specimen installation were fairly straightforward, requiring only fairings leading up to and down from the test specimen. These fairings were made on the aircraft after the tile test specimens were installed.³²⁰ Individual pressure transducers located on the surface measured pressure while the instrumentation system was contained in the fuselage.

The wing glove test article measured approximately 27 inches long and 14 inches deep (68.6 by 35.6 cm). The test article had eight tiles and leading edge gap fillers and was instrumented with surface flush mounted static pressure orifices, internal static pressure orifices, and a vibration accelerometer. The test article was mounted inverted on the F-15's left wing root fairing at an incidence angle of 1.5-degrees nose-up with respect to the wing root fairing in order to simulate space shuttle launch conditions, with the F-15 flying at positive angles of attack (thus replicating the orbiter's ascent at negative angles of attack).³²¹

The shuttle launch profiles for this test coupon were flown below Mach 1.1 because a normal shock wave that existed on the F-15 wing root fairing at that speed caused a potential overload on the test article at Mach numbers from 0.80 to 0.93.³²² (The maximum air load on the orbiter wing glove TPS was predicted to occur at Mach 1.1.) Nevertheless, exposing the test article to 1.4 times the designed aerodynamic pressure revealed no major deficiencies of the orbiter wing glove TPS, all parties were satisfied with the results, and no redesign was required.³²³

The wing leading-edge test article represented a 26 by 37-inch (66 by 94 cm) segment of the lower surface of the orbiter wing immediately behind the RCC. For this test engineers and technicians placed a wooden fairing, replicating the curvature of the orbiter's RCC leading edge, just forward of the test article, and mounted on the leading edge of the F-15's right wing. The forward-most row of close out tiles began just behind the trailing edge of the simulated RCC strip, followed by the test close out tiles. To reproduce predicted pressures expected in a cavity under the first row of close out tiles (over the D-cell), engineers and technicians pressurized this area for the tests.³²⁴ Behind this, more "acreage" tiles filled-out the test article, along with a thermal barrier and leading-edge gap fillers. The article was instrumented with flush surface static pressure orifices, internal static pressure orifices, surface dynamic pressure orifices, and a vibration accelerometer.

The F-15 wing was well suited for this test because its leading edge sweep matched that of the orbiter: 45 degrees. When flown at positive angles of attack the F-15's upper wing surface was analogous to the orbiter's lower wing surface during ascent, which flew at negative angles of attack. Slightly modified launch profiles had to be used for this test article to prevent too great a differential pressure on a critical tile near Mach 1.

The test results led to a re-design. During the tests, when the wing glove/close out tile section was flown to anticipated STS-1 aerodynamic and dynamic pressure conditions, the first row of close out tiles rotated aft and the gap filler extruded from between the trailing edge of the simulated RCC and the leading edge of the tiles, leaving an unprotected area on the substrate. The re-design included the filler assembly and tile substrate, followed by additional testing to validate the changes.³²⁵

The six "J" tiles represented a section of the orbiter's vertical stabilizer leading-edge and measured approximately 16 inches long and nine inches deep, with gap fillers between the tiles. Like the other test articles, this test article was instrumented with surface flush mounted static pressure orifices, internal static pressure orifices, surface dynamic pressure orifices, and a vibration accelerometer. Technicians mounted the test article on the leading edge of the right wing of the F-15 (about 40% of the wing semi-span) and not on one of the airplane's vertical stabilizers, again, because the wing and orbiter vertical stabilizer had the same 45-degree sweep. Engineers anticipated the maximum air loads on the leading edge of the orbiter vertical

³²⁰ Bohn-Meyer and Jiran, "Techniques for Modifying Airfoils and Fairings on Aircraft Using Foam and Fiberglass," Paper 81-2445, p. 3.

³²¹ Meyer, Jarvis, and Barneburg, *In-Flight Aerodynamic Load Testing*, p. 5.

³²² Aircraft speed and speed of the airflow over a wing are not the same. Because of the airfoil, airflow over the wing accelerates and it is possible to have supersonic flow at locations on the wing while the aircraft is still subsonic.

³²³ Meyer, Jarvis, and Barneburg, *In-Flight Aerodynamic Load Testing*.

³²⁴ Meyer, Jarvis, and Barneburg, *In-Flight Aerodynamic Load Testing*, p. 5. "A D-cell (or D-box) is a construction technique often used by aircraft designers to resist twisting loads. The name comes from the portion of the wing from the main spar forward where the skin wraps around the leading edge and back to the spar again to produce a "D" shape." Robert "Red" Jensen, email to Christian Gelzer, January 30, 2017. The orbiter D-box did not provide torsional stiffness.

³²⁵ Meyer, Jarvis, and Barneburg, *In-Flight Aerodynamic Load Testing*, p. 5.

stabilizer would come from sideslip, and since this test coupon was mounted horizontally, appropriate air loads were simulated with angle of attack in flight. Wing fences inboard and outboard of the test section prevented span-wise flow.³²⁶

The orbiter window post-test article was represented by an 18 by 24-inch (45.7 by 61 cm) segment of the window post and pseudo windowpane (from an area between windows three and five on the orbiter) using 12 tiles and the associated gap fillers. Calibration flights were done with wooden tiles to determine external surface pressure distributions: actual shuttle window posts could not sustain pressure orifices, and the flow field around the window post tiles was too complex to extrapolate pressure data from adjacent tiles. Technicians built and pilots flew a mock up with pressure sensors embedded that proved the solution to the latter problem. In addition to the same instrumentation used on the other tests, they mounted a collection of subsurface pressure ports as well.

They placed the test section on the upper surface of the F-15's right wing with the simulated windowpane extending forward from a window post to the wing's leading edge. Fences were installed inboard and outboard of the test article to try to limit the influence of span-wise flow on the test.³²⁷

Engineers predicted the maximum air load on the orbiter window post TPS would occur at Mach 0.9. In this case the orbiter design data, derived from limited wind tunnel data, were questionable. As a result, Center engineers obtained additional wind tunnel data from a 3.5% scale model of the orbiter with more detail and pressure orifices in the window area. The wind-tunnel model data were different in both trends and levels from the flight and design data. But the slope and differential pressure were considered the important parameters to correlate if they were to simulate TPS air loads, and the results were good. (This, despite the 3.5-scale wind-tunnel model data not agreeing in either trend or level with the flight and design data.)

Flying the J-tiles to the design dynamic pressure revealed a deficiency in that tile area's attachment method: pressures under the window post/close out tiles (SIP pressures) were higher than predicted, threatening to loosen or even lift some of the tiles in this critical area. Center engineers and technicians modified the attachment method of the test tiles, sealing the leading edge of the tile-to-window pane, and flew again to validate the change.³²⁸ "We flew all these tiles and actually simulated, not in time [history] but in air loads, the loads they would see during a launch on the shuttle," recalled Meyer. "We actually flew them to 1.4 times the load they would see during a shuttle launch."³²⁹

Rain Erosion Tests

During the first ferry flight of Columbia from the Flight Research Center to KSC the SCA flew around a thunderstorm, yet close enough that it encountered some rain. This was the same flight during which a number of tiles fell off the orbiter en route. Upon landing and subsequent examination, engineers noticed that some silica tiles had suffered impact erosion damage that they presumed was caused by the raindrops. The damage was quite unexpected and led to a set of tests which JSC asked be flown at the Center on the F-104 flying testbed. The silica tiles were hard enough and certainly resilient enough to withstand the heat of re-entry, but drops of water seemed to play havoc with them; this was unacceptable, particularly because the shuttles would be landing in rain-prone Florida or returning there via the SCA. Moreover, as Arvid Knutson pointed out, "there's enough space between the tiles that any water penetrating [that area] hydraulically pushes the tiles off of the shuttle; the water doesn't have any place to go—the tiles are just glued on."³³⁰

The Shuttle Program Office requested that the Flight Research Center conduct tests to help determine the "damage threshold of various thermal protection systems during flight through rain."³³¹ The office also arranged for the National Oceanographic and Atmospheric Administration (NOAA) to perform similar tests in Florida and from Edwards AFB using one of that Agency's Lockheed WP-3D Orions. (On the P-3 the test coupons were mounted on a pylon beneath the right wing.) The NOAA tests focused on the consequences of large raindrops at low speed striking a shuttle tile. Collectively, they tested a variety of TPS, from RCC to

³²⁶ Meyer, Jarvis, and Barneburg, *In-Flight Aerodynamic Load Testing*, p. 4.

³²⁷ Meyer, Jarvis, and Barneburg, *In-Flight Aerodynamic Load Testing*, and Meyer, Jr., interviewed by Gray Creech.

³²⁸ Meyer, Jarvis, and Barneburg, *In-Flight Aerodynamic Load Testing*, p. 4.

³²⁹ Meyer, Jr., interviewed by Creech.

³³⁰ Arvid Knutson, interviewed by Guy Noffsinger, Shuttle Documentary Interviews, October 2012, NASA Dryden, NASA AFRC Historical Reference Collection.

³³¹ Robert R. Meyer, Jr. and Jack Barneburg, *In-Flight Rain Damage Tests of the Shuttle Thermal Protection System*, (Edwards, CA: Ames-Dryden Flight Research Facility, 1988), p. 1

silica tiles. The plan at the Center seemed simple enough: attach various TPS at different angles to a fixture mounted on the FTF beneath the F-104, find rain, and go fly in it. The Center being in California and not Florida, however, and, particularly in the High Desert, rain was at a premium. So, as Meyer described it, the Flight Research Center contacted the Air Force down the ramp at Edwards AFB to see if the Center could fly the F-104 behind a tanker that had been modified to perform icing tests. That specially modified airplane, a Boeing NKC-135A tanker stationed at the base, was used by the Air Force to performing icing and rain tests on its own aircraft.³³² “It was essentially a refueling tanker that had this big ring on the back [of the refueling boom] that would spray water out, and for normal icing tests it would turn into ice, but it could also be used for rain,” recalled Meyer. “The idea was that we were going to fly behind this ring and allow the water that



The F-104 in flight behind the Air Force icing tanker spraying water. The tanker was designed to test anti-icing systems on Air Force aircraft and NASA initially used it to test the Thermal Protection System tiles for the shuttle. NASA EC85-33040-04

came out of it to impact the tiles and see what damage was caused.”³³³ The Flight Research Center simply needed to book flight time behind the tanker to complete the tests.

The flights began to mount yet, oddly, the F-104 airplane kept returning with no discernable damage to the tiles. “The tanker put out as much water as it could and went as fast as it could and there was no damage to any of the tiles. We were scratching our heads trying to figure out what happened and I was kind of seeing my career flash before me: here we designed this real expensive experiment and it wasn’t working,” Meyer remembered.³³⁴ Out of frustration, people at the Center began keeping an eye out for rain clouds. And then fortune stepped in: a rainstorm hit the area. “We actually had the tanker scheduled but we cancelled. We said: ‘we are going to go out and fly in some real rain because we’ve got it.’” They put the F-104 into the air as fast as possible and sent it off into the rain clouds. “The instant we hit rain the tiles almost exploded. Of course, I was very relieved because the experiment, the test fixture project we put together, worked,” he said.³³⁵ Not satisfied with one trip, the engineers kept changing out the TPS and sending the pilot back up to find more

³³² http://contrailscience.com/wp-content/uploads/nkc-135-icing-attachmentpv1983_2688.pdf, accessed Jun 7, 2018. Edwards Air Force Base is where military aircraft are sent for test and evaluation in order to be approved and accepted into the U.S Air Force. Icing tests are an integral part of the validation process.

³³³ Bob Meyer, interviewed by Guy Noffsinger, Shuttle Documentary Interviews, October 2012, NASA Dryden, NASA AFRC Historical Reference Collection.

³³⁴ Meyer, interviewed by Guy Noffsinger.

³³⁵ Meyer, interviewed by Guy Noffsinger.

rain. To the peculiar delight of the data hungry engineers, the tiles began coming back in horrible condition, chipped, cracked, and in some cases worn almost completely away. The results were both appalling and revealing. Under certain circumstances some tiles fared badly (factors included their angle to the flow and the size of the water droplets), but others were more resilient. “The impact energy for damage varies with rain drop size...tiles exposed to several launch and landing cycles appear to fail at lower impact energies than new tiles...[and] preliminary results indicate that launch or landing in light rain may be permissible without extensive damage...”³³⁶ Nevertheless, hunting for any moisture soon became the chief missions of the “Pathfinder” aircraft that eventually preceded every SCA ferry flight back to Florida.³³⁷

But what of the NKC-135A tanker and why had it not generated the expected results? It turned out that the tanker’s spray system actually produced small water droplets that turned to mist rather than rain, defeating the Center’s objective (and the Air Force’s too, so long as rain was the purpose). As an ice generator, the system worked well, but as an artificial rainmaker it turned out not to work at all and the Air Force soon shut down that portion of its program. The upshot was critical to the space shuttle orbiter program, for it revealed the fragility of the tiles to something at once so innocuous as a drop of water, yet which, at 250 miles per hour (402.3 km/hr), could have the equivalent impact of a bullet.³³⁸ “It’s funny,” mused Pete Seidl, “how they [orbiters] can come through all the temperature and back to Earth, and yet a little rain will just peel that off.”³³⁹

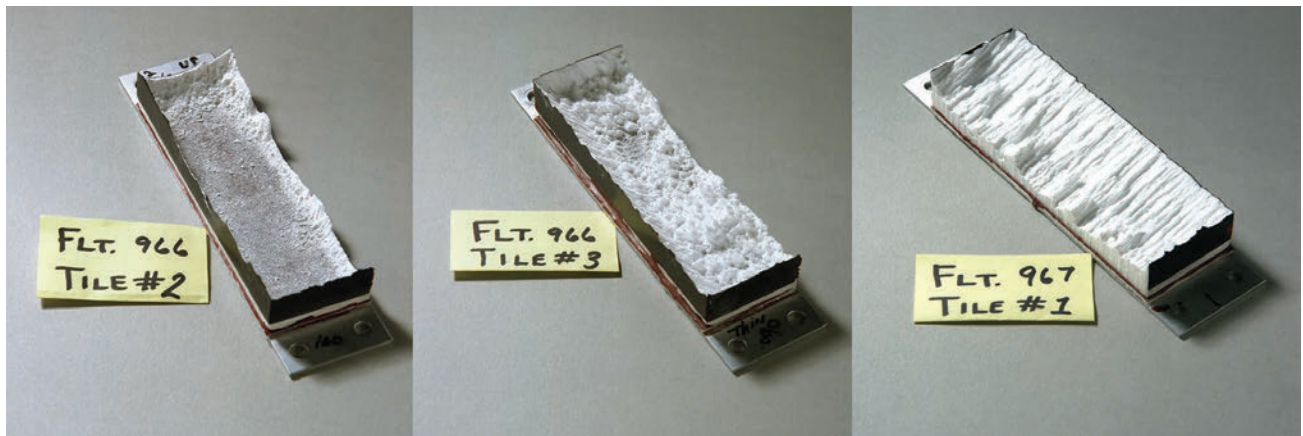

A collection of tiles flown on two flights in actual rain, showing the ablation. NASA EC85-33216-02, NASA EC-85-33216-03, NASA EC85-33216-04

Conclusions

In general, in-flight simulations of the predicted maximum air loads on the space shuttle orbiter for the various test articles were considered good. As a direct result of the F-104 and F-15 flight tests, two areas of the space shuttle orbiter TPS were redesigned and retested, and post flight inspection of the orbiter TPS following Columbia’s first spaceflight revealed that none of the areas modified following in flight tests at the Flight Research Center had failures attributable to air loads.³⁴⁰

And there were three larger points to take away from the tests series. First, the flight-test approach used during this study provided a database for the verification of wind tunnel and analytical predictions.³⁴¹ The expediency and effectiveness of the approach was due to several factors tied to the Center itself and its methods. Second, this in-flight testing exposed full-scale test articles to realistic air loads, unlike isolated wind-tunnel data gathered from smaller-scale models.³⁴² And third, the Center’s ability to respond quickly to

³³⁶ Meyer, Jr. and Barneburg, *In-Flight Rain Damage Tests of the Shuttle Thermal Protection System*, p. 5.

³³⁷ “Constraints include no flight through clouds; no flight in air cooler than 15 degrees Fahrenheit (-9 degrees Celsius); no flight in air with an ambient pressure less than eight pounds per square inch; no flight at night; no flight within 25 nautical miles of thunderstorms; no flight through moderate or greater turbulence.” “Air Force Weather Duo Guides Space Shuttle Home,” *Spaceflight Now*, November 19, 2000, <https://spaceflightnow.com/news/n0011/19ferry/>, accessed January 10, 2018.

³³⁸ Meyer, interviewed by Guy Noffsinger.

³³⁹ Pete Seidl interviewed by Christian Gelzer, June 13, 2001, NASA TV, Edwards, CA. Shuttle Documentary Interviews, June 2011, NASA AFRC Historical Reference Collection.

³⁴⁰ Meyer, Jarvis, and Barneburg, *In-Flight Aerodynamic Load*.

³⁴¹ For discussion of thermal blanket testing see Bianca M. Trujillo, Robert R. Meyer, Jr., and Paul M. Sawko, *In Flight Load Testing of Advanced Shuttle Thermal Protection Systems*, NASA TM 86024, (Edwards, CA: NASA Ames-Dryden Flight Research Facility, 1983).

³⁴² Meyer, Jarvis, and Barneburg, *In-Flight Aerodynamic Load*, p. 6.

the requirements of the tests provided for the best quality, most accurate, real world flight test data that any aerospace program or project could obtain.

“The FTF provided the ability to test the articles through a complete M versus q profile rather than testing discrete points as was normally done in wind tunnel tests.”³⁴³ The collective testing helped the Shuttle Program Office certify the orbiter TPS for flight, satisfying a NASA requirement of manned spaceflight. And because of the Center’s aircraft and experience, the Shuttle Program Office returned in subsequent years with additional tile-related tests, which the Center completed.

³⁴³ Meyer, Jr., *A Unique Flight Test Facility*.

Operations

9: NASA 25: The Convoy Commander's Vehicle

George Grimshaw

NASA (ret.)

NASA Armstrong Flight Research Center

Abstract:

Drawing on experience with mobile control rooms used at the AFRC in the 1960s and 1970s, engineers modified an old motorhome to serve as command vehicle of the convoy that met a returning space shuttle orbiter. Over the years the Center acquired a new motorhome with better capabilities, which engineers modified for the job and dubbed NASA 25. The convoy grew over those years as requirements changed but NASA 25 remained the nexus of all activity surrounding an orbiter that landed at Edwards AFB.

Keywords:

George Grimshaw; United Space Alliance (USA); White Sands Space Harbor; Harry Talbot; Bill Shelton; Modes

Of the 135 space shuttle launches, 54 flights (including eight of the nine first flights) ended with a landing at Edwards Air Force Base in California, where the NASA Armstrong Flight Research Center is located. The first landing at Kennedy Space Center (KSC) did not take place until February 11, 1984 (STS-41B, Challenger), nearly three years after flights began.

Regardless of where the orbiter landed, once it came to a complete stop on the runway there followed a complex and carefully orchestrated process to reduce the hazards inherent to the vehicle—which were numerous and serious—and allow ground personnel access to the orbiter. This process enabled the extraction of the astronauts and the eventual movement of the orbiter that, until this process was completed, remained parked where it rolled to a stop on the runway. When the orbiter landed on the Kennedy Shuttle Landing Facility (SLF) runway the time this took (“safing”) was more or less academic, because the SLF was principally dedicated to the orbiter and its presence deprived no other aircraft of the runway’s use. When the orbiter landed in California, however, because it landed at Edwards Air Force Base the main runway remained closed until the orbiter was towed away. Thrilled though everyone was on the base at the sight of a successfully returning spacecraft and the fact that the Air Force was hosting it, its constant presence on the main runway literally kept the base from fulfilling its primary purpose as a flight test center. (Excepted were the last 12 space shuttle flights, by which time a new, temporary asphalt runway at Edwards AFB could be used until the orbiter was towed clear of the main runway.)³⁴⁴ Expediting the safing of the orbiter and towing it back to the Flight Research Center, not to mention getting the astronauts back on solid ground, took priority.³⁴⁵

A collection of specialized vehicles was assembled for every launch and landing. Assembling a convoy for a landing seems obvious; doing so for a launch may seem less so; however, every time a shuttle lifted off NASA activated contingency landing sites just in case something went wrong during the ascent or on the first orbit. Edwards AFB / AFRC was one of the prime alternate landing sites, and as such the base shuttle assets were

³⁴⁴ In April 2008 an F-16 christened a temporary runway at Edwards AFB, built to allow continued operations while the base’s main runway was being rebuilt. That temporary runway paralleled the original runway but was located between it and the main base. STS-126 became the only orbiter to use this runway, when Endeavour was diverted to California and landed there on November 30, 2008. The addition of a second runway provided other aircraft landing opportunities once the orbiter was down. <http://www.edwards.af.mil/news/story.asp?id=123099491>, accessed December 7, 2011.

³⁴⁵ Dryden’s shuttle office had the obligation to support shuttle landings at Edwards. The various tasks were performed under contract by firms such as Serv-Air, RCA, Smith Engineering, and Rockwell International. Sources of work also included the Air Force as the representative of the DoD. Memo from Ames R C to VT-EPD-1/A, Harley/C, and Baker/C, from DoD/R. (Russ) Eddington, re: STS-6 Support Requirements, April 1, 1983, pp. 1-3.

A memo dated June 15, 1983, from the same source to the same recipients, specifically calls on Serv-Air to provide: “annual proof load [be] performed . . . on 50 ton shackles for MDD.” Memo from Ames R C to VT EPD 1/A, Harley/C, and Baker/C, from DoD/R. (Russ) Eddington, re: STS-6 Support Requirements, April 15, 1983, p. 2. Maintaining certification of the MDD certification meant at least biannual tests of this kind, as well as regular servicing of the landing aids set up on the dry lakebed to assist in orbiter approaches and landings.

activated, without fail, for every launch.

Whether for launch or landing, a carefully choreographed convoy of vehicles moved down the long taxiway from the Flight Research Center to the main fire station on the Main Base, where a final briefing took place. The convoy contained a variety of rescue vehicles, such as ambulances with medical teams; vehicles carrying decontamination equipment; and vehicles required to service the orbiter (including the enormous purge and cooling transporters). By the end of the orbiter program the convoy was made up of as many as 29 different vehicles, each with a special purpose and a crew. Once arrived at the orbiter, the job of managing this human and mechanical ballet amidst a collection of toxic vapors fell to a small group who stayed in communication with various team members while checking off steps from a list in careful sequence. This small group oversaw the entire process of rendering the orbiter safe, extracting the astronauts, and finally, moving the orbiter off the runway and to the Center.

The NASA 25 Convoy Commander's Vehicle, a converted motorhome outfitted with the necessary communications systems and equipment for shuttle post-landing recovery and towing operations, was the lead convoy vehicle and a Center innovation that made its debut on April 14, 1981 for the landing and recovery of STS-1. This vehicle was a mobile command center.



The shuttle convoy snaking its way onto taxiway B at Edwards AFB. NASA 25 has the lead, while on the runway sits the shuttle training mockup; this is an exercise, one of several held ever year. NASA EC05-0079-15

The Center space shuttle orbiter convoy was following a tradition begun at the Center with the X-15 (the world's first reusable spacecraft). A collection of vehicles from NASA and the Air Force gathered on Rogers Dry Lake in preparation for each return of the X-15. They began moving (and not necessarily in an orderly fashion) even as the X-15 was sliding across the dry lake after landing. Once the X-15 came to a stop the crew ensured that the toxic chemicals on board posed no hazard, removed the pilot from the aircraft, and then began the preparing the X-15 for transport back to the Center. Each particular X-15's crew chief (there were three aircraft) was on hand, but an inspector ensured that certain activities were completed and that the pilot had finished his checklist before exiting the aircraft.³⁴⁶ To be sure, NASA 25 was a marked refinement over

³⁴⁶ The X-15 was powered by anhydrous ammonia and liquid oxygen, as well as 90% hydrogen peroxide, and carried high-pressure nitrogen and helium, which were toxic or extremely dangerous and had to be carefully tended to after a landing. John McTigue telephone interview with Christian Gelzer, December 8, 2011. McTigue was a former NASA X-15 Operations Engineer.

anything the Agency had used in the past.³⁴⁷

The key individuals in NASA 25 directed an extremely complex task in “safing” the orbiter, overseeing the astronauts’ descent from the White Room stairs (and their typical walk around the vehicle for post flight inspection), and finally moving the orbiter from the runway back to the Center.

Orbiters returned from space carrying residual fuels and chemicals of different kinds, including monomethyl and dimethyl hydrazine, ammonia, hydrogen, Freon 21, nitrogen tetroxide, and oxygen under pressure. Until these chemicals had sufficiently dissipated or the source had been mitigated, no work could be done on the orbiter, and only those wearing protective suits could approach the orbiter.

Shuttle orbiter operations in California were performed under an inter Center agreement between KSC and the Center. A separate agreement existed between the Department of Defense (DoD) and NASA for the latter’s services at landing sites such as Edwards AFB and the NASA facility inside the Army’s White Sands Missile Range, NM. (Separate agreements were made for emergency landing sites in Europe and elsewhere.) What the Air Force provided to NASA at Edwards far exceeded what the Center could offer. The apparent disparity between NASA and Air Force personnel in key areas was because the orbiter landed at an Air Force base: even though the orbiter was NASA’s responsibility, it landed on Air Force property and therefore the Air Force had certain responsibilities as well for what happened before, during, and after landing. In the event of any kind of shuttle contingency, the NASA Convoy Commander was responsible for declaring a contingency “mode”; which mode he called depended upon what contingency had occurred. No matter what mode, however, control of the scene fell to the Air Force; NASA stood back in an advisory posture.

NASA 25

Howard Morefield, Chief of the Avionics Communications, Navigation, Electrical, Television and Telemetry Section, remembered the original plan for the Convoy Commander’s vehicle as a passenger van. The layout put the NASA Convoy Commander (NCC) in the front passenger seat; in the rows behind him sat the On Scene Commander (OSC) and the Rockwell Ground Operations Manager (Ops), Quality Control (Quality) representative, and the NASA and Rockwell Safety representatives. Using handheld radios, these individuals communicated with their respective elements in the convoy team during orbiter recovery and towing operations. Each of these individuals had specific functions following a landing. The NCC served as NASA’s senior manager, in charge of the convoy and the recovery operation. The Rockwell (later United Space Alliance or “USA”) Ground Ops Manager served as the senior contractor manager (Rockwell International was the chief contractor on the orbiter itself, responsible for designing and the assembling the vehicle). The OSC was there because it was an Air Force installation and he served as the DoD representative. The OSC, in the event of a contingency, would take over the scene while all other parties stepped back, and it was the people under the command of the OSC who would move in to respond. The driver would be a communications technician in order to assist with any problems related to handheld radio communications. Only one passenger van was built with this capability; it stayed at Vandenberg AFB, CA, where the DoD had planned to launch and land space shuttle orbiters, until the Challenger accident happened.³⁴⁸ To accommodate the personnel and equipment another special passenger van was built, which was longer and wider than the typical passenger van. In the early 1990s the Air Force transferred this van to the Center, where it was outfitted with a cone penetrometer system and used to test the hardness of Rogers lakebed at Edwards.

Because of limited interior space and problems with handheld radio communications and power (battery), Morefield went to the Center’s Shuttle Support manager, Charlie Baker, with the proposal for outfitting a motorhome with a communications system and work space. Working with his counterparts at KSC, Baker

³⁴⁷ In the 1960s Dryden used a different motorhome as a mobile control center, dubbed NASA 9. Yet another motorhome, NASA 15, was used as a telemetry vehicle during projects such as the Lunar Landing Research Vehicle (LLRV) program since virtually all the flight tests on that project took place at South Base, which was largely abandoned and beyond visual range of Dryden itself. From within NASA 15 engineers oversaw not only in flight telemetry, but the preflight and post flight activities of the LLRV. Unlike NASA 25, however, that control center did not have to reposition itself to function. Gene J. Matranga, C. Wayne Ottinger, Calvin R. Jarvis and D. Christian Gelzer, *Unconventional, Contrary and Ugly: The Lunar Landing Research Vehicle*, (Edwards, CA: NASA Dryden Flight Research Center, 2006), pp. 90-91.

³⁴⁸ Vandenberg Air Force Base (Rancho de la Concepcion, as the original Mexican land grant was known) had been established to enable high inclination rocket launches for military and reconnaissance purposes. Jenkins, *Space Shuttle: The History of the National Transportation System*, p. 467.

received approval for the idea, and gave Morefield the go ahead to acquire and outfit a suitable vehicle. To simplify things, Morehead arranged to use a 25 foot (7.62 m) 1968 Ford Condor motorhome that the Center had already obtained from the Air Force. He assigned technician (later Chief of the Instrumentation, Calibration and Repair Section) Bill Kelly to design and oversee the refurbishment of the vehicle with the necessary systems, equipment, and interior furnishings. The result was an ideal way to transport the key shuttle ground personnel while enabling them to communicate with all essential parties following a landing.

Kelly saw to the installation of a stretch of windows in the motorhome just behind the driver's seat, providing a panoramic view. In front of the windows his team installed a four-place workstation with captain's chairs facing out the window. The four spots were to be occupied by the three individuals representing Quality, Safety, and Operations, and the OSC. A workspace for the NCC was installed at the passenger's seat at the front of the motorhome. Both the driver and the NCC had captain's chairs, since the missions would be long ones. Many hours were spent sitting in the coach going over checklists with people working on the orbiter, because work could not proceed to the next step until approval was received from the individual in the command vehicle to whom they reported. For efficiency, a Center technician served as a combination driver and Communications Technician (Comm. Tech). An 8 foot (2.4 m) window was also installed on the passenger side of the motorhome, behind the side entry door. In front of this window the team placed a bench seat for a second Center Comm. Technician and Quality and Safety representatives. Carpet was laid for both aesthetics and insulation. A military style aircraft communications system featuring an intercommunications system (ICS), two VHF and two UHF air-to ground radios, four Motorola Converta-Comm land mobile radio units, and headsets with microphones, were added to the growing complement of communication equipment. Kelly saw to it that a wind monitoring system was included, along with a room style air conditioner, bottled water dispenser with hot and cold water, and a small refrigerator. A generator capable of powering all of these systems and equipment was essential. Best of all, there was a restroom! Somewhat primitive by today's standards, NASA 25 had all of the creature comforts of a state-of-the-art mobile command post.

And good thing it was, too.

The runways at Edwards AFB are somewhat remote, with no facilities at hand - especially the lakebed runways, which are miles from the nearest structure. NASA 25 provided the crew with everything necessary to safely and relatively comfortably oversee the recovery and towing operations of an orbiter, despite the fact that the activity often lasted 10 or more hours. During that time no one but the astronauts left the shuttle or convoy for anything but a critical issue, placing convoy crewmembers on a distant runway, miles from any conveniences, for hours on end. Water, shade, cooling, and a restroom were vital to the health and safety of all involved.

Kelly was assisted by other technicians in the section, including Joe Ray, Mark Anderson, Bob Delaney, and Ralph Cullum. Cullum and Ray's names appear on a checklist for both the launch and landing of STS-1, indicating that they staffed the initial command vehicle—the passenger van—as Driver and Technician for Abort Once Around (AOA), Early End of Mission (EEOM) and End of Mission (EOM), landing, recovery and towing operations. Early End of Mission was the contingency plan in case something happened to the orbiter in flight after the first orbit. Abort Once Around referred to an emergency landing during the first orbit, with the assumption that the shuttle would land at one of the primary or continental United States (CONUS) contingency landing sites.³⁴⁹

Going into Flow

Typically, about 14 days before launch, the Shuttle Support Team went into “flow.” In anticipation of a shuttle launch, technicians assigned to provide NASA 25 support began preparing the vehicle.³⁵⁰ Preparation

³⁴⁹“I began training to provide shuttle convoy landing-and-recovery operations support as a driver and communications technician on NASA 25 in late 1984, only a few months after arriving at Dryden. This training involved completing the OV-220 Orbiter Convoy Operations course, and Shuttle Area “A” and “B” training, as well as on-the-job-training to operate and maintain the communications systems in NASA 25, and how to lead the convoy from the Shuttle Area out to the various staging sites for landings, then back to the Shuttle Area during orbiter towing operations. An integral part of the NASA 25 driver's responsibility was to make sure the NCC received, and was able to respond to, radio transmissions during convoy operations. Due to the frequency of landings at Edwards Air Force Base in the first decade of shuttle operations, convoy end-of-mission simulations were held frequently and I learned the ropes of convoy operations under the tutelage of Charlie Baker. My first mission providing support as the NASA 25 driver/comm. tech. was Mission 51A in November 1984.” George Grimshaw, written notes to Christian Gelzer, June 2011.

³⁵⁰Going into “flow” was the date Armstrong's support entered the critical path for launch and meant that everyone's activity in Area

included a thorough inspection of the vehicle to ensure fuel, fluids, and tire pressures were at acceptable levels and that the systems and equipment were properly set up and operational. Meanwhile, other activities were going on in the Shuttle Area related to the launch: members of the Shuttle Support Team began preparing the mate-demate-device (MDD) to ensure it was ready to lift the orbiter onto the Shuttle Carrier Aircraft (SCA) if it landed in California. Others made sure the necessary gasses were on hand to purge the orbiter (nitrogen and helium), and to sustain operations while preparing the orbiter for flight back to KSC. Once preparations were complete, a technician signed the Site Readiness Report vouching for the Center's readiness to support the mission. NASA initially expected that after a short proving period during which the orbiters would land on the dry lakebed at Edwards, and then the main runway on base, subsequent shuttle landings would take place at KSC. Excepting STS-3, which landed at NASA's White Sands facility in New Mexico, later named "White Sands Space Harbor," the first eight shuttle flights concluded their missions at Edwards and the Center.³⁵¹

Starting with STS-11/41B and for a time thereafter, the orbiters landed at KSC unless weather or problems on board the vehicle dictated a diversion to Edwards.³⁵² However, during STS 23/51D's (flight 16) landing at KSC, a tire blew out. Until full nose wheel steering could be tested and then activated for landing, and more importantly, the reason for the tire's explosion understood and resolved, shuttle management decided to bring the shuttles back to Edwards, where the lakebed accommodated approaches from multiple directions and the runways were much longer and smoother than the single runway at KSC, and even the base's main runway was smooth.

Preparations

Grimshaw recalls gearing up for landings.

On a typical launch day, the shuttle landing crew at Dryden would arrive at the Center some 5 hours before to launch to prepare the convoy command vehicle; 4 hours before launch we staged it with other convoy vehicles in the Shuttle Area. This ensured that the NCC, Operations, Quality Control and Safety representatives could be onboard and perform their communications checks in accordance with the appropriate Shuttle Landing and Post Landing Operations Orbiter Maintenance Instructions.³⁵³

The shuttle landing convoy grew over time. For STS-2 the Center had 18 vehicles of different kinds ready for the post landing convoy. This convoy included three fire trucks from Edwards Air Force Base but, at that point in the program, but no security related vehicles and no helicopters shown on the manifest, although they were in the air.³⁵⁴ By STS-134 the official vehicle count stood at 29, not counting helicopters, of which there were typically six toward the end of the program.

A was directed toward an orbiter landing as early as launch day, unencumbered by any extraneous work that might otherwise occupy the day. It also meant the cessation of certain activities at the Center, such as construction or modification of systems, to ensure that the status quo ante remained the status quo. Any problems or maintenance actions that arose during flow had to be reported to the appropriate engineering organization at KSC so that Armstrong's support posture was always known.

³⁵¹ Once known as Northrup Strip, the NASA site is located within the Army's White Sands Missile Range.

³⁵² NASA initially listed shuttle flights in sequence: STS-1, 2, 3, and so on. This convention lasted until flight 10, after which a different rationale took over; flight 10 somehow disappeared in the shift. Starting with STS-11 NASA added new numbers and a suffix to help clarify things (e.g., 41D). Within and without NASA flights tended to be referred to by the new number-letter sequence. The new nomenclature broke down accordingly: the first digit indicated the fiscal year in which the manifest for the flight was put together—which was unrelated to when the flight took place—4, as in 1984 (it's unclear what would happen in 1994)—followed by a digit indicating the launch site: 1 for Kennedy, 2 for Vandenberg (never used), and an alphabetical letter indicating the *planned* (not actual) launch sequence in the year, A for first, B for second and so on. (NASA never launched 12 shuttles in a single year—the letter L being the 12th—making the letter's continued use a never ending sign of hope.) The Agency abandoned this illuminating nomenclature in 1988 with the launch of STS-26R (which was the 26th launch). It did so because launches slipped, and when they slipped badly, later manifested flights took their place, as they long had. But this method played havoc with the STS sequences. On October 3, 1985 STS-28/51J lifted off; the next flight off the pad was STS-30/61A, on October 30, 1985. By January of 1986 NASA was back to STS 33/51L.

³⁵³ Grimshaw, written notes, June 2011.

³⁵⁴ The Air Force provided all security, fire, rescue, and medical personnel for shuttle landings but their contribution doesn't seem to have been indicated on the paperwork. While Dryden had NASA flight surgeons and a nursing staff on hand for each landing, NASA medical personnel were far outnumbered by their Air Force (often supplemented by volunteer medical staff from other service branches) counterparts.

“Once all of the convoy elements were in position and ready,” recalls Grimshaw, “we would stand down for launch.”³⁵⁵ After launch, if the Center was identified as the AOA landing site, the convoy crews would staff their vehicles, reestablish communications, and roll out from the Shuttle Area, across the flight line and down the long taxiway to the staging site in preparation for a possible landing. The initial staging area was on Taxiway D for a lakebed runway landing, or Taxiway B for a runway 22 or 04 landing. Later in the program the initial staging area was changed to Taxiway E, the main taxiway to the Flight Research Center, next to the Edwards Fire Station and opposite the Main Base control tower.

Recalled Harry Talbot and Bill Shelton:

We [Air Force personnel] sometimes sat in NASA 25 or at the fire station. We wouldn’t know that the shuttle was coming until we were actually inside the window. Would it get here before our airplanes would get back from wherever they were? We’re trying to do this fine balance: should we call people back, are we coming to Edwards, are we not coming to Edwards, what are we going to do—because we had requirements. We were always on this fine line.³⁵⁶

Although an AOA was never declared during the history of the space shuttle program, there were scheduled rehearsals to support a landing just in case. Practicing for such an event was a regular exercise involving NASA, the Air Force, and all the other supporting elements that came to the base to assist in a landing.

During a shuttle flight, about 2 ½ hours before the anticipated landing time, all convoy personnel reported to their respective vehicles for “call-to-stations” in the Shuttle Area and prepared to roll out. Two hours



Standing outside of NASA 25 for a final briefing are Brig. Gen. Jim Hogue, (Ret.), on the left, wearing sunglasses and in uniform, and Dean Schaaf, NASA KSC Convoy Commander, wearing a hat and looking at the camera is. Hanging on the side of the mobile command vehicle are placards showing danger zones around orbiter as well as the convoy assembly. NASA EC05-0079-20

³⁵⁵ Grimshaw, written notes, June 2011.

³⁵⁶ Harry Talbot and Bill Shelton Oral History Interview, June 7, 2011, in the NASA DFRC Historical Reference Collection. As a flight test center Edwards kept flight operations going until the last minute. Typically, this meant keeping aircraft in the air as long as possible on test missions. The base operates two supersonic corridors for aircraft; calling aircraft back requires planning.

before landing, the convoy departed the Shuttle Area for the initial staging area. Approximately 90 minutes before landing the NCC held a final briefing. Following this briefing and confirmation that the orbiter was in fact coming to Edwards/Flight Research Center, the convoy rolled on, lining up a few hundred yards east of Taxiway D for a lakebed landing or on one of the three taxiways to the main runway, close to where the orbiter was expected to come to a stop. By this time the airfield had been closed to traffic and there was to be no vehicle movement within a specified distance of the runway. (The restriction on vehicular movement extended to some of the roads neighboring the runway and the flight line.) The location of the convoy was determined by the direction from which the orbiter was expected to land, which is a function of wind. Once in position, the convoy remained in place even if the shuttle landed from the opposite direction, which occasionally happened because of fluctuating winds. (If it were an exercise the team would then practice recovering the orbiter just as they did when the shuttle landed here.)

While a shuttle was in orbit, the Center was the daily EEOM PLS (Emergency End of Mission Prime Landing Site) most of the time, which meant that all convoy personnel were on call in case the orbiter needed to land before the scheduled EOM. Shuttle flights had wide impact on the Center, even if that impact was not always apparent. Shuttle related employees were on call for the duration of a shuttle mission and had gone “in flow” two weeks before the mission launched. While “in flow” civil engineers at the Center stopped all modifications to the Center’s systems in case any modifications had unintended or unexpected consequences on communications, response capabilities, or the ability to service the vehicle once it was down.

Initial shuttle landings occurred on the expansive surface of Rogers Dry Lake, at over 44 square miles long the signature feature of Edwards Air Force Base. Once the orbiter’s status had been downgraded to a relatively safe condition (purge and cooling system transporters attached to its aft section via umbilical hoses), and the astronauts disembarked, the orbiter was towed back to the Center. The tow convoy moved at the speed one would expect from a tug pulling a vehicle typically weighing in excess of 200,000 pounds (90,718.5 kg). If the landing occurred on the lakebed, there were a number of ways to leave the lakebed and enter either at taxiway D, between the main base and the Center, or go directly to the Center. Usually the tow back was uneventful, but not always.

I remember well flight 61A, Challenger’s last landing. Prior to orbiter tow, the recovery team decided to tow Challenger back to the Shuttle Area on the lakebed from lakebed runway 17 instead of exiting the lakebed at Taxiway D and the concrete surface. During the tow, as the convoy neared the Shuttle Area Ramp just north of the compass rose, Challenger’s tires began to sink into the lakebed, bringing towing operations to a halt. In order to finish the tow, [Charlie] Baker brought some 1-inch sheets of plywood out to the orbiter and the convoy team jacked Challenger’s wheels up and slid a sheet of plywood under them and then placed another sheet in front of each of them. The tow resumed with convoy personnel rotating the sheets of plywood as the orbiter slowly rolled from one sheet to another until it rolled onto the Shuttle Ramp. From then on orbiters landing on the lakebed were towed to Dryden via Taxiway D.³⁵⁷

Grimshaw was a member of the convoy team providing AOA support for the ill-fated 51 L mission on January 28, 1986, when Challenger and her crew were lost during breakup following an explosion shortly after launch.

We were all in the Shuttle Office, watching what appeared to be a normal launch. About 70 seconds later Commander Dick Scobee announced the familiar “go at throttle up” and then a white cloud appeared followed immediately by white exhaust vapor streaks going in different directions. It got real quiet in the room. We weren’t exactly sure what had happened. We kept expecting to see the cameras picking up the orbiter heading back to KSC to land. But it never did. After what seemed like an eternity, the convoy was released and we performed our post ops procedures and went back to our work places. The hours and days following were very surreal as we learned what had happened and mourned the loss of the crew and Challenger.³⁵⁸

³⁵⁷ Grimshaw, written notes, June 2011.

³⁵⁸ Grimshaw, written notes, June 2011.

By the time of Return to Flight, in September 1988, Grimshaw was the Lead Avionics Communications Technician at the Center.

For STS-26R, I was back at the helm of NASA 25. It was memorable, not only because it was Return to Flight, but because Vice President George H.W. Bush came out to observe the landing. The convoy had to stop short of crossing the approach end of runway 22 on its way out to stage for a lakebed runway 17 landing, as Air Force 2 was on approach to land, so the convoy team watched Air Force 2 land and then proceeded to the staging area. After shuttle Discovery landed, Vice President Bush, accompanied by California Governor, George Deukmejian, came out to greet the crew, closely guarded by Secret Service Agents. A Secret Service Agent was posted inside the door of NASA 25 and we were not allowed to leave our seats until he left the vehicle.³⁵⁹

During this time Grimshaw also led the development of a replacement vehicle for the aging NASA 25. He wanted to model the replacement after the original vehicle, with the communications systems equipment rack located in the rear of the vehicle providing better access for technicians to operate and maintain the systems during shuttle operations. Instead, the decision was made to model the replacement vehicle after the NCC vehicle at KSC, which at the time had the communications systems equipment rack located mid-vehicle.

When the replacement vehicle was delivered to the Flight Research Center, Grimshaw, his supervisor, Al Harris, and Charlie Baker performed the formal receiving inspection. To his shock, Grimshaw remembers finding the front grill of the vehicle merely wired in place. During the trip to the Center the grill had fallen off and the driver reattached it using whatever wire was handy: it looked like baling wire. He also discovered that there was no air flow from the vents into the cabin heating and air conditioning system; the manufacturer, it seemed, had decided to use the narrow gap between the roof and the ceiling of the vehicle as ducting for the system as requested, but crossmembers in the ceiling blocked the flow of air. The statement of work to be performed on the command vehicle called for an expanded metal catwalk on the roof, which would double as a ground plane for the “antenna farm” to be installed on the roof of the motorhome, but the manufacturer had simply glued down a plastic catwalk.³⁶⁰ These were just a few of the problems the trio found during the inspection, and they refused the vehicle. During their inspection they also discovered that having the communications systems equipment rack located mid-vehicle took up too much space and obstructed the traffic flow as people entered and exited, adding yet another problem to an already unacceptable vehicle. A new RFP went out for a mobile command post.

Grimshaw was more intimately involved with the procurement of the second replacement vehicle, and he designed the layout of the floor plan, including locating the communications systems equipment rack toward the rear of the vehicle. NASA contracted with the Airstream Company to supply the motorhome, and this time the Center did not follow KSC in lockstep, but relied on its own, greater experience with mobile command centers.

A few months later, Airstream delivered the new NASA 25, a 32.5 foot (9.9 m) coach which easily passed muster during the acceptance inspection. For the next several months Grimshaw led the build-up and installation of the communications and other systems of the vehicle. His team included Joe Akers, Cullum, and Howard Trent from the Avionics Communications, Navigation, and Video Group; Bob Sawyer and Rob Anderson of the Sheetmetal Shop; and Center Shuttle support contractor technician, and Curt Bailey of General Electric. Once the systems were operational, the Center PA-30 Twin Comanche aircraft was used to test the range of the communications systems. Grimshaw performed radio voice tests from the right seat of the Comanche with former shuttle astronaut Gordon Fullerton as pilot. Fullerton had come to work at the Flight

³⁵⁹ Grimshaw, written notes, June 2011.

NASA's shuttle mission numbering went through different phases. At one point it hoped a more arcane system might identify several things about a mission simultaneously. Unfortunately, in consequence the primary number itself may bear no relationship to its place in the flight sequence, and without paying attention to any suffix—in this case “R”—it is possible to confuse it with another mission of the same number. STS-26, 51F launched July 29, 1985; STS-26R launched on September 29, 1988.

³⁶⁰ The expression refers to such an array of different antennae that they appear to be under cultivation. “Ground plane” in this instance refers to radial wires connected to a vertical antenna that is grounded in order to provide suitable radiation characteristics.” William T. Guoan, notes to Christian Gelzer, January 27, 2017.



NASA 25, a converted Airstream® motor home, was the culmination of Dryden's experience in mobile command centers. Four people sat at a long fixed table in front of the four windows to monitor different post-landing activities taking place with the orbiter. NASA EC89-0351-03

Research Center following his time as an astronaut. Grimshaw later led the effort to produce a documentation package for NASA 25. The new NASA 25 made its first trip for the landing of STS-34 on lakebed runway 23, in October 1989, with Grimshaw in the driver's seat.³⁶¹

Changes in technology and requirements led to many modifications made to both NASA 25 vehicles over the years, between shuttle flights. One major change led by Grimshaw came in 1994, after he'd researched, tested and proposed the use of a new multi-band air/land/mobile transceiver to replace the single band transceivers being used for air-to-ground, ground, and mobile communications at the Center, including inside NASA 25. That summer he traveled to KSC to brief Shuttle Communications engineer Jim Devault on the new radio, who liked it so well he replaced all of the single band transceivers in the communications kits used at the shuttle Transoceanic Abort Landing (TAL) sites.³⁶²

Although the orbiters belonged to NASA, any landing at Edwards involved an array of non NASA participants. This was true when the shuttle landed at the KSC, but it was even more so when it landed at Edwards since it was coming to an operational Air Force base. When landing at KSC a team consisting of more than strictly NASA personnel tended to the orbiter (the majority being contractors). At Edwards, handling the orbiter after wheels stop was much the same, but supporting any landing and any launch entailed far more than merely NASA and NASA contractor personnel. The military, for example, provided one doctor and two support specialists for every astronaut on board the shuttle for every launch and landing, a number far higher than NASA would supply for a landing other than KSC. To do this the Air Force called on volunteer

³⁶¹ In March 1994, Grimshaw received the prestigious Silver Snoopy Award, a manned spaceflight awareness award, presented by the Astronaut Office to both NASA employees and contractors for outstanding contributions to human spaceflight, given in recognition of his years of outstanding Shuttle landing and recovery support at Armstrong.

³⁶² Not every duty related to NASA 25 entailed coordination with ground personnel or JSC: "After STS-67 landed at Edwards, on March 18, 1995, NASA Administrator Dan Goldin, his daughters and infant grandson came out to the runway during recovery operations and greeted the convoy crew and then walked around the shuttle Endeavour. For safety reasons, they didn't want to take his grandson near the orbiter and the baby's mother decided to stay behind in NASA 25 while her sister and Goldin went to the orbiter and then the sister would come back and watch the baby while the baby's mother went out to the orbiter. I volunteered to babysit so they could all go out to the orbiter together." Grimshaw, written notes, June 2011.

flight surgeons and nurses from the area Navy and Army bases. The same was true for other personnel, from security forces to helicopters to rescue crews. Edwards always provided fire and rescue crews for anything on the base itself.

Every launch and landing was a well-meshed activity of many different actors who joined to make a single team - true as well for those who staffed NASA 25. The OSC was present in the mobile command vehicle to handle “Modes” (emergency scenarios) should they arise. Initially the OSC was a senior Air Force officer, typically the Base Commander or a senior colonel. Eventually, and largely because of the constant rotation of military personnel, the OSC responsibility fell to representatives who did not relocate every three years. Two such individuals, Harry Talbot and Bill Shelton, attest to the intimacy of NASA 25 brought on by the close quarters and the hours and hours of duty on the runway.

Talbot: The Grounds Operations Manager (GOM) was in the passenger seat of the command vehicle. [Elsewhere this position is identified as the NASA Convoy Commander (NCC)] You had a radio tech who is now head of Manned Space Operations here at NASA, [who] was our driver (George Grimshaw) but at the time he was the radio tech so he was there to help with that. You had one Air Force person literally on the engine mount. I was in the van the other day; they have a chair for us now.

Shelton: Oh!!

Talbot: You were sitting on the engine mount. We [Shelton and Talbot] were this close [holding two fingers half-an-inch apart] for hours and he was rubbing shoulders with the Ground Operations Manager and right next to me was the Quality Assurance person, so how did we get along? Well, you knew how everybody was feeling because you could see their eyes, and it was an advantage really. We built this incredible team of Joe [D’Agostino] and Larry [Biscayart] and it wasn’t just because it was, but it was because we had been together for years. We knew how each other thought.³⁶³

The Flight Research Center, White Sands Space Harbor, and KSC had to be prepared to handle an orbiter in case of an AOA, in the unlikely event that the orbiter needed to return promptly to Earth. Depending on the spacecraft’s path, one of these three sites was selected as the EEOM PLS in case the shuttle reached orbit and the payload bay doors would not open (which would require the shuttle to de-orbit and land). When the Center was selected as the AOA and/or EEOM PLS on launch day, shuttle personnel were scheduled to be at work before or shortly after launch.

When a shuttle was in orbit, Mission Control at JSC made the decision of where to land. Preference was always for KSC, but circumstances—typically weather—sometimes necessitated an alternate site. The Flight Research Center / Edwards was the first choice as the alternative for a number of reasons. One was the infrastructure at Edwards and the Center that facilitated any landing there, high among them the permanent MDD with which to load the orbiter onto the SCA for its return to Florida.

When confronting a landing other than at KSC the decision was usually held off until the last minute, typically approximately 90 minutes before the de-orbit burn. Once the de-orbit burn had occurred, it took just under an hour until the shuttle touched down, giving the recovery crew at the Center only that small window for final preparation. A shuttle did not have the option to land on every orbit, so, for the Center, there were typically two, and sometimes three, chances for a landing on a given day, and those landing times were separated by just over 90 minutes.

In 1998 Armstrong turned over the responsibility of the NASA 25 Convoy Commander’s vehicle to the Center shuttle support contractor, and Grimshaw stepped away from shuttle support and into other responsibilities at the Center. Eight and one half years later he returned as the Shuttle Project and Operations Manager, a position for which his NASA 25 and convoy experience had prepared him well, and from which he supported the remaining 18 flights of the Shuttle Program.³⁶⁴

³⁶³ Harry Talbot and Bill Shelton Oral History Interview, June 7, 2011.

³⁶⁴ In addition to Grimshaw and those previously mentioned, the NASA technicians who provided convoy support with NASA 25 included: Joe Akers, Randy Cone, Bill Sabo, Todd Shaw, Howard Trent, and Howard Winsett. The list of SSL&RASS technicians included David Baldwin, Danny Medina, Elliott Hill, Ben Jones, Heidi Molina, John Wood, Ray Mowery, and Hugo Ballesteros.

10: Edwards Air Force Base and Shuttle Landings

Christian Gelzer
Logical Innovations, Inc.
NASA Armstrong Flight Research Center

Abstract:

Activities associated with shuttle landings at Edwards AFB were similar to those at Kennedy Space Center, the principle difference being the large presence of the Air Force in place of NASA. The Air Force had been part of NASA's first reusable spaceplane in the 1960s (X-15) at Edwards and it continued to play a central role with the shuttle as Edwards served as the prime landing site, and then as the first alternate site once the shuttle began landing in Florida.

Keywords:

County of Los Angeles Fire Department; Brig. Gen. Jim Hogue; Bill Shelton; Security Police; East Camp

The Flight Research Center and Edwards Air Force Base (AFB) in California have been the landing site of spaceplanes starting with the X-15, and rocket planes before that. The Base and the Center were designated the prime landing site for the space shuttle orbiter during the initial flights of the program, a role it surrendered to the Kennedy Space Center (KSC) once the orbiters were deemed "operational." After that, the California landing site became the first alternate landing site, called up when circumstances made landing at KSC unacceptable.

Every time a shuttle landed at Edwards AFB it was soon surrounded by a collection of different vehicles, each of which had a specific function. As the orbiter's propellants and chemicals were tapped and it was made safe for unrestricted access, more and more people descended from these vehicles to begin preparing to move the orbiter off the runway and back to the Flight Research Center. Much the same thing played out at the KSC when a shuttle landed there.

Amidst the similarities, there were obvious differences in the two landing sites: lush Florida greenery and the occasional alligator versus the ochre of the California High Desert and the bare hills and mountains surrounding the Antelope Valley and Mojave Desert where Edwards AFB is located. But one profound difference stayed virtually invisible to all but the trained eye: the Air Force's centrality in every shuttle landing at Edwards (other elements of the military were regular and essential partners as well). This was, first and foremost, because when the shuttle came to California it landed at an operational military base, making the Air Force ultimately responsible for the spacecraft and its occupants once it was on the runway.³⁶⁵

This began even before Columbia first launched on April 12, 1981.

Starting in 1977 the Flight Research Center hosted the Approach and Landing Tests (ALT) with Enterprise, the prototype orbiter used to validate the flight characteristics of the spacebound shuttles within the atmosphere as well as their approach and landing performance, all at Edwards AFB. Enterprise first landed on Rogers Dry Lake and finally on the base's 15,024 by 300 foot (4.58 km by .091 m) concrete runway. Getting Enterprise to the base involved an overland move from Rockwell International's assembly facility at Plant 42, in Palmdale, CA, through the city of Lancaster and to the base itself, a trip of some 35 miles (56.3 km) to Edwards AFB. The Air Force escorted the final portion of this trip across its land to a taxiway leading to the Center; security was the purview of the Air Force.³⁶⁶

"We had a huge transporter that we would put the vehicle on and literally transport it down city streets," said Robert Kahl. "I can remember prepping the city streets prior to Enterprise's first trip down—used to be called 10th Street East, now it's called Challenger Way. We removed stop signs, streetlights, telephone poles, trees to make it wide enough to accommodate the width of the wings for a 35 mile overland trip out to Edwards. I can remember that first day that we transported Enterprise. The people lined up on the streets.

³⁶⁵ This is not to say that members of the military played no role in shuttle landings at KSC; in fact, they were central there as well. The principal difference was that KSC was a NASA facility and the Agency was the prime factor in all things.

³⁶⁶ This spectacle was repeated for every one of the orbiters, save Endeavour, because there was no version of the mate-demate-device (MDD) at Air Force Plant 42 to lift the new orbiters onto the back of a SCA until the orbiter lifting frame (OLF) was transferred from Vandenberg AFB to Plant 42. That happened once the Air Force cancelled plans to launch from Vandenberg, following the loss of Challenger, in 1986.

The nucleus of the public didn't really know what the space shuttle was or what it was going to look like. The oohs and aahs and the applause—goose bumps—it was pretty amazing.³⁶⁷ And it was the Air Force that provided security for Enterprise once the orbiter landed, most notably the one time on the Edwards main runway.



Orbiter Columbia being moved overland from Palmdale, CA, where it was assembled (Air Force Plant 42) to Edwards AFB. At Edwards it was towed to Dryden, lifted by the Mate-Demate-Device onto the Shuttle Carrier Aircraft, and flown the Kennedy Space Center. All the shuttles but Endeavour were delivered to Dryden this way. NASA EC79-10312

As the launch of STS-1, Columbia, approached, the Air Force geared up for a much larger task than it had ever handled at the base. Columbia was aloft for two days on its maiden flight and returned to a lakebed landing at Edwards on April 14, 1981, where a crowd of at least 400,000 people awaited it, camped out on both sides of Rogers Dry Lake. For many attendees and viewers alike this was the first realization that the military had a role beyond the fact that the orbiter was landing on an Air Force base.

Harry Talbot came to Edwards AFB in 1981 as a First Lieutenant just out of the National Guard. His first job as a reservist on his first day of duty at Edwards was with the Security Police working the public viewing area for STS-1, a unit glibly dubbed the “East Side Dust Suckers” for the area and conditions in which its members had to work (“dirt and dust were everywhere”). “Envision that side of Edwards Air Force Base with 500,000 people, more RVs than an average city has, [and] similar to the Wild West. There were more people than I have ever seen in one place - rows and rows of RV’s, people, vendors - the only way to get to the site

³⁶⁷ Robert H. Kahl interviewed by Rebecca Wright, Downey, California – 25 August 2010, NASA STS Oral History Project, Edited Oral History Transcript. http://www.jsc.nasa.gov/history/oral_histories/STS-R/KahlRH/KahlRH_8-25-10.htm, accessed January 23, 2012.

was around the lakebed.”³⁶⁸ Because of the remoteness of Edwards AFB people came from far away and arrived on site a day, perhaps even two or more, ahead of the landing, making their stay several days under a cloudless sky on a dry desert lakebed in confined area on a military base. “[There weren’t] enough Air Force Security Forces, so we got support from Army National Guard or Reserve - radios went dead we were on duty so long.” The shuttle announced its arrival with a double sonic boom overhead—even though it was barely visible at perhaps 50,000 feet (15.24 km) in altitude—followed by a breathtakingly steep descent in silence to a landing on the lakebed. All told, the moment of drama everyone waited days for happened in less than three minutes. “After the shuttle landed a motorcycle broke out from the public viewing area and raced toward the shuttle. Security Forces stopped him.”³⁶⁹



The crowd gathered on the eastern shore of Rogers Dry Lake at Edwards AFB for the landing of Columbia on April 14, 1981, its first flight. NASA ED06-0045-2

The staff at Edwards anticipated supplying Security Forces for a landing but the size of the crowds for the first landing eclipsed what the even Air Force leadership at the base could muster, and so it called on additional support from other elements of the military, including the National Guard. This procedure soon became standard for landings at the base, and especially so when President Ronald Reagan and First Lady Nancy attended the landing of STS-4 on July 4, 1982. Not surprisingly, security was especially tight.

The crowds were beyond belief, and we were short on Security Police. I had a gun checked out and on me for over 36 hours; I was probably awake and on duty for 48 hours. People started coming in 2 to 3 days early; it was a giant party. We had Civilian [Air] Patrol cadets augmenting us from other units - we gave them a badge, a beret and put them to work - I was riding over the desert in an Army reserve jeep not sure if we were going to tip over or not. At the end, after the radios were dead, we just controlled our troops with commander’s intent - who ever had any rank or leadership went out and took charge of what we could. We were not prepared for the size of the crowd.³⁷⁰

³⁶⁸ Harry Talbot, Oral History Interview with Harry Talbot and Bill Shelton by Christian Gelzer, June 7, 2011, NASA AFRC Historical Reference Collection.

³⁶⁹ Harry Talbot, email correspondence with Christian Gelzer, May 12, 2011. “Dryden’s Contributions to the Shuttle Program Notes.” NASA AFRC Historical Reference Collection. For more details see Christian Gelzer, editor, *The Spoken Word III: Recollections of Dryden History, the Shuttle Years*, NASA SP 4552, (Edwards, CA: NASA Dryden Flight Research Center, 2013).

As the shuttle aligned with the runway the orbiter’s descent was angled down as much as 19 degrees below the horizon.

³⁷⁰ Talbot, Oral History Interview with Harry Talbot and Bill Shelton by Christian Gelzer, June 7, 2011.

To supplement those on the ground, the Air Force put Security Forces in the air, aboard helicopters. Often these helicopters came from the Army's Fort Irwin National Training Center, CA, some 85 air miles (136.8 km) away, which sent personnel as well. Patrolling the side of a 44-square mile (114 km sq) dry lakebed that held several hundred thousand people was no simple task even when the people were invariably well behaved. On one of the shuttle landings, Talbot flew as an armed member of a security team aboard a helicopter and had to chase off reporters who moved onto the lakebed with the intent of approaching the shuttle after it had come to a stop. During another landing his team got a call about a man with a gun positioned in the rocks above the viewing area; they sent a helicopter security team to bring him in. It turned out that the man was merely looking at the shuttle through the rifle scope, but by the time the security forces "got him in a car, all he wanted was to get away from the guy with the gun pointed at him."³⁷¹

"During the early days," recalled Talbot, "the shuttle was a big deal for the military side of Edwards - EVERYONE got into the act - every cop worked - fire, medical- the chaplains were out, the mess hall stayed open - we all felt like we were part of history - it was a NASA project - but it was landing at Edwards with test pilots flying - It was truly a team effort."³⁷²



Columbia landed on runway 23 and came to a stop near the compass rose in front of Dryden, at the intersection of three other lakebed runways: 30, 15, and 18. Runway 18 had been used by the X-15 and lifting bodies. NASA ED06-0045-6

³⁷¹ Talbot, Oral History Interview with Talbot and Shelton by Gelzer.

³⁷² "By around mission 10 they were glad to have a lowly reservist run the close-in security team - the fact that I was available and had been around 4 or 5 years at that point made me a prime candidate to run this SF duty - it was still the Air Base Wing commander that ran the Shuttle program - Eddy Leader - we would not have many exercises as at that point we were getting a landing it seems every few weeks- I took over the team - so much fun being part of what was happening in the news - by this point I was working at a school and the principal just knew I would be gone when the Shuttle was landing. The NCO's ran the show - I sat in on briefings and learned the ropes - the hardest part was the Tow - 4+ hours - we were in the 'Bread Truck', a small box truck out fitted with a desk, radio and maps - we had a sergeant keeping the units where they belonged - trying to talk over the radios to our security people in the security chopper and talking to Eddy Leader." Harry Talbot, email correspondence with Christian Gelzer, May 12, 2011. "Dryden's

Talbot recalled what it was like when crowds were similarly large to the first landings:

Return-To-Flight [following the loss of Challenger] was a very big deal - by this point we had moved a semi-trailer out as our command post - no more tents, and we had generators to recharge the radios. I had been working all night - at one point NASA Public Affairs called, asking how many people were in the viewing area - my answer was: "it's dark, my radios' are dying, take 300,000 people now- 400,000 at daylight and 450,000 at landing." That was the official number; later, when we looked at the aerial photos it looked closer to 550,000. The crowd for Return To Flight was large, but again, friendly. When the shuttle landed you could hear a pin drop: everyone was focused on the safe return, and then the cheering and the flags broke out. Once again, the Army Reserve was on hand and they were a big help: we just did not have the base staff to supervise it all-at one point the people were taking the wood slats out of the fence to make fires to stay warm. We also had to take out fencing to get extra room to park cars.

After the landing everyone wanted to leave at once - the big incident was the RV crash - granddad was in the RV with his children and grandchildren - a "Long Hair" in a Hillman or some small car, cut off Gramps and scratched the RV - at that point Gramps pulled a gun out of the glove box and the situation went to hell fast - our Cops were close so they grabbed Gramps and the gun, when I arrived Gramps was in hooks [handcuffs], the daughter was screaming at me, the grandchildren were crying - it was a general mess - we took Granddad away and let the hippy go - after all, the hippy didn't pull the gun... What a day.³⁷³

The Air Force was responsible for more than just security on base; safety of the astronauts and those on the ground was also its purview, meaning that fire, rescue, and medical care in the event of an accident were its concern, not NASA's. While NASA trained for handling the orbiter and astronauts after a landing, all of its work was predicated on an uneventful landing. The Air Force and its partners were ready for the worst case.

To that end, exercises simulating either a straightforward landing or one of a number of different mishaps were regular events at Edwards AFB and involved all the supporting parties, all of it orchestrated by the Air Force. These were carefully structured exercises built around a variety of emergency scenarios, or "Modes," and in each case one initial rule applied: should an emergency befall the shuttle on approach or landing at Edwards AFB, NASA's responsibility ceased for the indefinite future and the Air Force took over, the base being Air Force property and the assets that were responding to the emergency being Air Force controlled. Regardless of the Mode, it was the Air Force and its partners whose job it was to respond to what happened and make the astronauts safe. It was for these events that they gathered to practice several times a year.

In July 2008, for example, Air Force Brig. Gen. Jim Hogue, individual mobilization augmentee to the commander of the Air Force Flight Test Center and director of the Edwards Space Shuttle Contingency Recovery Team, oversaw a training exercise at Edwards for an emergency landing. "We need to stay up to date on how we would react in case of an emergency landing," he explained. "When space shuttles need to land here, we have to be sure we know exactly what to do." More than 100 Edwards, NASA, and other DoD personnel participated in the exercise.³⁷⁴

"Team Edwards has a need to keep our space shuttle recovery skills current," said Col. Larry Edge, 95th Mission Support Group augmentee during the same training exercise. "We've been planning this for at least three months." The exercise simulated a space shuttle landing on one of Edwards' short runways, leading to a fire in one of the orbiter's wheel wells - a Mode VI - in which rescue personnel assist some astronauts in exiting the vehicle while others require assistance to escape.³⁷⁵

Other elements of the base supported the exercise, as they always did, including the Security Forces

Contributions to the Shuttle Program Notes." NASA AFRC Historical Reference Collection.

³⁷³ Talbot, email correspondence with Christian Gelzer, May 12, 2011. Return To Flight marked the orbiter's first flight after the loss of Challenger in January 1986, which led to an extensive investigation and subsequent modification of the shuttles themselves as well as the solid rocket boosters. "Dryden's Contributions to the Shuttle Program Notes." NASA AFRC Historical Reference Collection.

³⁷⁴ <http://www.edwards.af.mil/news/story.asp?storyID=123108898>, accessed March 5, 2012. "Individual Mobilization Augmentees (IMAs) are Air Force Reservists assigned to active-component units and government agencies." <http://www.military.com/military-report/air-reserve-individual-mobilization-augmentees.html>, accessed March 27, 2017.

³⁷⁵ <http://www.edwards.af.mil/News/Article/396358/nasa-edwards-practice-for-future-shuttle-landings/>, accessed June 7, 2019.

Squadron, Civil Engineer and Transportation Directorate, the Operational Support Squadron, Medical Group, and the Communications Squadron. In addition to medical personnel from Edwards, the exercise saw participation by medical staff, including nurses and flight surgeons, from March Air Reserve Base, CA, the Naval Medical Centers in San Diego and Fort Irwin, CA, and the Civil Air Patrol. The two elements of the Flight Research Center that played a role in these exercises (beyond the shuttle office personnel): public affairs and the few members of the Center's medical staff:

The [NASA] public affairs side [was] involved: in the event of a major mishap we actually go down to the local hospitals and we stand by to receive the crews and to help out as far as interacting with the media and the public. We practice those regularly and work with the Air Force on that. Prior to a landing we always have a meeting together to define who's doing what role. Then we do walk throughs in the event of a contingency. We do that every time.³⁷⁶

Meeting its safety, fire, rescue, and medical obligations meant that the Air Force and its partners provided emergency rescue equipment and staff. The fire engines and equipment typically came from Edwards, but ambulances (including helicopters ready to evacuate astronauts to regional medical centers if necessary), as well as medical staff invariably came from afar. The Flight Research Center had a flight surgeon on staff who, along with nurses from the Center, always supported a shuttle landing, but this was nothing compared to what the military could and did provide. "Certainly, one of the key elements involving the Air Force was crash and rescue," recalled Joe D'Agostino, the Center's long time Shuttle Operations Manager. "They were very important to the program because they were responsible for transport to hospitals, and for the disaster preparedness. Their fire and rescue people were key players not only with ALT but through the whole development phase, especially the fire people, who had to go into the orbiter and get familiar with systems."³⁷⁷ For each astronaut on board the orbiter the Air Force and its partners (Navy and Army) had on hand one flight surgeon and two nurses on hand for a landing. This was the case for every exercise as well, a figure NASA could not match.³⁷⁸

Even the County of Los Angeles Fire Department supplemented the Air Force and its partners with equipment and services for landings and training. Recalled Frank McCarthy:

Being such a large fire department we had a lot of resources that were at the disposal of Edwards and NASA for this mission. Most important were our helicopters. We have three Sikorsky S-70 Fire Hawks available for Medi-vac, firefighting and transporting crews. We had helicopters on stand-by throughout the years, and we always had one in Lancaster during landings.

We also supplied our Heli-spots and Heli-tenders for refueling the U.S. Army helicopters to extend their search range. We have heli-spots all over the county and several Heli-tenders to man them.

Under FEMA/US&R heavy rescue team [plans], L.A.Co.F.D. could put up two 70-person teams that can be federalized for search and rescue on a shuttle mission. The county actually sent many of its people to Texas after the Columbia accident to assist in the retrieval of debris.

We maintained Hazardous Material Teams--four fully manned Haz-Mat Teams in the county available 24 hours a day, one in Lancaster. This team was always on stand-by during landings.

And finally, we had the Heavy Rescue Unit on stand-by during landings. This plus a quick phone call would have had all the fire engines, ladder trucks, water tenders, and paramedic

³⁷⁶ Jenny Baer-Riedhart, Oral History Interview, January 13, 2002, NASA AFRC Historical Reference Collection.

³⁷⁷ Joe D'Agostino, Oral History Interview with Christian Gelzer, June 2011, NASA AFRC Historical Reference Collection.

³⁷⁸ "For a landing at Kennedy there was normally one lead flight surgeon and his deputy per mission. If there was an international crewmember, then that [sponsoring] agency would normally also have a flight surgeon for that crewmember. When we were bringing an ISS long duration crewmember home on the orbiter, then we also had a flight surgeon for that person. Normally two nurses on the Crew Transport Vehicle and sometimes one or two more if they were there to support some kind of a special medical experiment that required immediate blood draws or something else ASAP. Once back at the O&C, then there was a cast of dozens to do all of the tests." Email notes from Jerry Ross, via Dr. Jennifer Ross-Nazzal.

squads you could ask for.

We also sent people to the Space Medicine and Astronaut/Shuttle Training when it was offered.³⁷⁹

Virtually none of this was noticeable to the casual observer, who only saw a flow of NASA and contractor personnel move about an orbiter after landing, making ready for the astronauts to exit in their blue flight suits. Almost unseen were the Air Force fire trucks and personnel, the Navy, Air Force, and Army flight surgeons and nurses ready but in the background, the Medi-vac helicopters with “Airdocs” and Parajumpers on board, the Army and Navy helicopters flying overhead with security personnel ensuring the area was secure, or the people and assets made available by Los Angeles County or volunteers from the Civilian Air Patrol. Collectively, they far outnumbered what NASA mustered for a landing; like the many who work behind the scenes, without whom an opera, movie, or play would be impossible.

³⁷⁹ Frank McCarthy, email correspondence with Harry Talbot, June 7, 2011, “Dryden’s Contributions to the Shuttle Program Notes.” NASA AFRC Historical Reference Collection.

11: The Airdocs' Perspective

Dr. Richard Shih-Shien Chou, M.D.,
U.S. Navy, 144th Fighter Wing (ret.)

Abstract:

Flight surgeons attended every shuttle landing with typically a surgeon and deputy per mission when landing at Kennedy Space Center. When landing at Edwards AFB the ratio of doctors to astronauts was invariably one-to-one. Lacking that many flight surgeons, NASA and the Air Force called on volunteer flight surgeons from the surrounding area, calls answered by the likes of Richard Shih Shien Chou and his colleague, Timothy Atmajian, both of the U.S. Navy. Each was specifically trained for this work and served as a volunteer.

Keywords:

Space Operations Medical Systems Training Course (SOMSTC); USAF Rescue Parajumpers (PJs); H-60 Blackhawk; Cape Canaveral; Naval Air Station Lemoore

Richard Shih Shien Chou's connection with NASA began as a child playing with a diecast NASA space shuttle with rocket boosters. He grew up in the 1980s and dreamed of becoming an astronaut. That boyhood dream came crashing down on January 28, 1986, on his eighth birthday, while he sat in his second grade class and heard the news of the space shuttle Challenger explosion.³⁸⁰ "I recall that night having a birthday cake and watching my father glued to the TV watching the McNeil/Lehrer Newshour. Space shuttle Discovery would return to space when I was in the fifth grade."³⁸¹

While at the University of California Irvine Chou was involved in a NASA muscle atrophy research experiment involving the space cycle - a bicycle that created centripetal force. The objective of the experiment was to create macrogravity conditions that decreased the risk of muscle atrophy that significantly affects astronauts during prolonged space flight. In medical school at the Uniformed Services University of Health Sciences, the military's tri-service medical school in Bethesda, MD, several visiting professors working at NASA came to speak to Chou's classes, so he retained a connection to NASA, even if it was a distant one. His first direct involvement, in flight school, came at the Naval Air Station, Pensacola, FL when one of the flight surgeons there made him aware of the opportunity to become a NASA space shuttle contingency flight surgeon. He promptly called the number given him and reached SMSgt. Tom Riesenber, who later had a major impact on his involvement with NASA. Riesenber happened to be in Europe on a trip to visit the TAL (Transoceanic Abort Landing) sites, but he made Chou aware of the Space Operations Medical Systems Training Course (SOMSTC), which took place in October of 2006, at Patrick AFB, adjacent to Cape Canaveral, FL. The training was offered only once a year. Chou was going through flight school in Pensacola, FL, at the time, but found a way to enroll after earning his wings.

There were over 25 flight surgeons at SOMSTC when he enrolled, from all three branches of the military; he even found several of his classmates from flight school in Pensacola in attendance. "Our roles in the program varied. Some of my classmates were trained to cover the alternate landing site at Marine Corps Air Station Cherry Point, NC. It was at this course, that I realized the sophisticated orchestra of moving parts to cover all contingencies of a space shuttle flight."³⁸²

As a NASA Airdoc, my role was to be the physician on the military rescue chopper that transported the astronaut to a hospital in the event of an emergency, to the assigned or predetermined and approved medical center for further evaluation and treatment. We would fly in the Sikorsky MH-60 Blackhawk helicopters of the 301st Rescue Squadron, part of the

³⁸⁰ STS-23, 51L Challenger launched on the morning of January 28, 1986. Failure of an O-ring on the right solid rocket booster led to a fire that breached the external tank containing liquid oxygen and hydrogen. The resulting explosion destroyed the orbiter; there were no survivors. The shuttles did not fly again until September 1988.

³⁸¹ Richard Chou, written recollections, email correspondence with Christian Gelzer, February 22, 2012. "Dryden's Contributions to the Shuttle Program Notes." NASA AFRC Historical Reference Collection.

³⁸² Chou, written recollections, email correspondence with Gelzer. Shuttle missions, particularly ones with military payloads, were sometimes put into high inclination orbits. In these cases the orbiter's ascent roughly paralleled the U.S. East Coast, making sites such as MCAS Cherry Point in North Carolina possible abort landing sites.

45th Space Wing. Each flight crew consisted of pilot, co-pilot, two crew chiefs, two USAF Rescue Parajumpers (PJs), and the flight surgeon. Usually, each mission used four crews, one for every two astronauts, which meant four airborne emergency helicopters. There was one doctor and two PJs (one per astronaut) per helo.³⁸³



Navy Flight Surgeon Richard Chou next to an H-60 Blackhawk Medevac helicopter during a shuttle training exercise. Though it appears large, the interior space dwindled quickly once medical staff and all the equipment were put aboard. DSCO 3273 Photo courtesy of Richard Chou

If the Aircraft of Opportunity (AO) were different, meaning the rescue team was obliged to use something other than a H-60 Blackhawk, they might only be able to carry one astronaut in an emergency. When Chou came to Edwards AFB to volunteer, for instance, he flew in Army helicopters that came out of Fort Irwin, CA, and the aircraft and configurations were, in fact, sometimes different.

Dr. Chou had been trained to assume that, with the H-60, he'd have the room and the capacity for two astronauts if he needed to evacuate both at the same time. The PJs worked as air ambulance paramedics and supplemented the Airdoc once the astronauts were in the helicopter; this was quite different from what normally happened in the civilian circumstance.

Usually, in most civilian and military air ambulance settings, physicians do not ride along in the helo, unless, as we do in CCATT (critical care air transport team), patients are on ventilators while being transported and need a physician on board. For the shuttle program the PJ's and docs worked together to optimize the patient since the flights could be 2-4 hours long, depending [on] how far you had to fly you to pick them up and how far they were from the most suitable emergency center. Going into this you assume that emergencies aren't

³⁸³ Chou, written recollections, email correspondence with Gelzer.

necessarily going to happen at the airport where you're waiting, so your transit time to and from the accident site might take quite a while. Having the PJs also gives the aircraft greater ability to use the physician in the event of a deteriorating patient.³⁸⁴

Along with Chou in the helicopter was a dedicated bag with medication typically used for Advanced Cardiac Life Support and Rapid Sequence Intubation, as well as basic tools such as splints, bandages, et cetera. These were all provided to the medical teams. The benefit of having a doctor on board following an emergency was that they could push medications, from things as simple as anti-nausea medications to something as complicated as epinephrine (epi) to keep an astronaut's heart beating. "My biggest fear," recalled Chou, "was always the oxygen supply, since we had the equivalent of only two small tanks and might run out in a very short time if the oxygen need and demand was high and the flight was long."³⁸⁵

The SOMSTC course taught the doctors and nurses various launch and landing contingencies and situations in which they might be involved. NASA identified eight accidents or emergency scenarios (Modes) that might befall the shuttle that could be addressed by personnel on the ground. To aid in responding to an emergency, the shuttle program applied numbers to the Modes; all of the emergency responders had to know which Mode number they were responding to, then they were ready to act accordingly.

Mode VIII was an emergency over-the-water bail out; an "off the runway" landing (Mode VII) required primary air ambulances to respond. Some flight surgeons had stations on the ground, and their responsibilities varied according to their positions. During the course, the new Airdocs got a tour of the Shuttle Launch Pad and the Shuttle Landing Facility, both of which initially became their home for the missions. They also gained familiarity with the special equipment, and just as importantly, came to understand the limitations of space and equipment in the back of the cramped helicopter. While the MH60 Blackhawk is a large helicopter, if one starts to fill it with emergency personnel and the necessary medical equipment—even the most minimal tools—space dwindles quickly. Another key detail the school taught was the way that local medical centers were selected when it came to shuttle astronauts and their individual needs. These were not incidental details. A major factor in this had to do, naturally enough, with what had happened to the astronaut that needed transporting.

The Airdocs were expected to handle up to two astronauts per helicopter. The flight surgeon would usually put a critical patient with an astronaut that was not as critical so as not to deplete resources in a helicopter. One thing Chou and his classmates learned quickly was that most of the helicopters used outside of Cape Canaveral were usually not primarily air ambulances since such aircraft "don't grow on trees and aren't just sitting around all over the place waiting for the shuttle to land. The helos we used were called up from whatever military base had assets they could make available, so most of the time we brought our own gear on board the helo. This takes up space, so oxygen supply, which is bulky, was limited, as were some of the other equipment we brought aboard."³⁸⁶

On most missions, the airborne medical teams were given a pretty up-to-date list of the hospitals and their capabilities. "Usually, when I worked shuttle landings at Edwards AFB, for more severe injuries, such as burns and other trauma, we were to fly the astronauts to UCLA/USC medical centers, both of which have burn centers and trauma centers."³⁸⁷

Chou and the other airborne flight surgeons had two specific roles when working a shuttle landing, the most immediate of which was to tend to an injured astronaut and to stabilize the individual while airborne. The second role was to be the eyes and ears of the physicians on the ground at whatever hospital they were flying to, since they needed to know as much about the inbound patient as possible, and Airdocs were specifically trained to provide relevant information.

Largely because of our training and our proximity to the patient, we had the authority to overrule what the physicians on the ground might have wanted us to do. As a flight surgeon, we were not just physicians; we were an integral part of the aircrew. We spoke the aviation

³⁸⁴ Chou, written recollections, email correspondence with Gelzer.

³⁸⁵ Chou, written recollections, email correspondence with Gelzer.

³⁸⁶ Chou, written recollections, email correspondence with Gelzer.

³⁸⁷ Chou, written recollections, email correspondence with Gelzer. When the Center had sufficient advance notice of a landing to arrange for it, Dryden Public Affairs regularly sent a PA representative to the designated hospital as a contingency.

language and could communicate this to the pilots, hospital personnel, and the mission commanders. This was why it was so important that individuals such as Tim [Atmajian] and I, and the entire collection of volunteer Airdocs that worked the shuttle program, were not simply physicians: we were flight surgeons: our patients were spacefaring pilots, after all. Had they been deep sea divers you'd have wanted a different kind of doctor on hand.³⁸⁸

After completing SOMSTC, Chou asked to start being involved with the shuttle missions right away, but he found it would be difficult since many who have been involved with the missions had been working on them for years. Turnover came slowly. While the work was voluntary as well as over and above one's regular work, the pride and excitement of working on the shuttle program had an allure that often challenged logic: flight surgeons and other volunteer support personnel gave up a great deal for the opportunity to serve on the missions. Chou would have to start from the bottom, which meant volunteering as an alternate with no guarantee of being selected for future missions.



Navy Flight Surgeon Richard Chou on deployment to the Kennedy Space Center as a flight surgeon in support of a shuttle landing. DSCO 3580 Photo courtesy of Richard Chou

Luckily, STS-116 was approaching and my girlfriend, now my wife, and I were going to vacation in Orlando, FL, so I asked to be an alternate in case I was needed for a mission. Naturally then, in the middle of my vacation, I was called to duty 48 hours in advance, while the orbiter's launch slipped from December 7 to December 9, 2006. I was told that another attempt would be made, but its launch was also unlikely. As things often went with the shuttle, when you least expect it to go it went, and the unlikely attempt was successful. I, on the other hand, was able to watch the launch from my hotel in Orlando in the evening since they'd cancelled my call-up. At night, the rocket boosters look like little lighted toothpicks falling from the sky.³⁸⁹

³⁸⁸ Chou, written recollections, email correspondence with Gelzer.

³⁸⁹ An Air Force officer at Edwards who was part of the recovery team that was called up for every launch in case of a landing at the base took to calling the shuttle "a holiday-seeking missile" since it invariably seemed to land at Edwards during long weekends,

After demonstrating his earnestness in serving on the mission, Chou was asked to be the Airdoc for a Mode VII mission, an exercise combining all the NASA and DoD components in simulating an off-runway landing. The exercise took place at Cape Canaveral, on the Shuttle Landing Facility. It was an eye-opening experience for him because he saw how his decisions had an impact down the line. It was also exhilarating to use the skills he was trained for, not only as a flight surgeon but also as a NASA Airdoc. Although the training mission was cut short by lightning in the area, there was still a mountain of lessons learned taken from so brief an outing. The doctors and nurses had to go through SOMSTC at least every two years (either at Edwards or Cape Canaveral) to stay current for the volunteer work.

Said Chou: “From what I know, on the Canaveral side, there were about 20 active Airdocs. Each year through 2007, they trained about 30 new ones a year. For some flight surgeons, it was a checkbox on a resume; for others, who covered the alternate landing sites in Europe and the U.S., it was a genuine commitment.” From his time at Edwards, he calculated that there were about 10-15 active doctors who mustered for a shuttle landing—expected or potential; “I know of five Navy Airdocs, including myself, and four of us were active duty. I know the Edwards flight surgeons were active duty (I think there were five of them). Most of us outside of Edwards augmented the Edwards crews.”³⁹⁰

Following his training and accreditation, Chou was involved in nine shuttle missions, starting first as an Airdoc for the STS-120 (Discovery, which launched on October 23, 2007 and landed at KSC). In 2008, he transferred to Naval Air Station, Lemoore, in California’s San Joaquin Valley. Because of his experience with the shuttle program he was asked to become an Airdoc at Edwards AFB, being only a few hours from his new station. While traveling from Texas to California he stopped at Edwards en-route to become requalified as an Airdoc for NASA, and to provide experience and leadership to this new group of medical evacuation personnel. At the time his supervisor and friend, Lt. Col. (Ret.) Tom Hoffman was the facilitator of this event. Hoffman was a DoD surgeon and Chief of the Bioastronautics Division of the Human Space Flight Support/ Det 3.

Typically, a few weeks prior to a shuttle mission Chou and Atmajian (a Naval Flight Surgeon also stationed at NAS Lemoore) would give the shuttle program their schedules so that program managers at Edwards would know what personnel were available. Sometimes Edwards would be the primary alternate landing site; other times it wouldn’t be, but they were always ready because plans for the shuttle when in orbit could change at a moment’s notice. The flight surgeons could get a call at 2:00 a.m., or 4:00 a.m., and have to get on the road to Edwards right away: for Chou and Atmajian it was a 3-4 hour drive to reach Edwards from NAS Lemoore. Chou’s schedule for the Navy as a flight surgeon meant that he could only volunteer on weekdays, meaning he missed quite a few landings.

Once on base the two reported to the clinic at Edwards, which served as a gathering point for the medical personnel scheduled to work a shuttle landing during possible shuttle landings. Often they’d get there, or walk in the door, only to see their mission called off or postponed; such was the nature of the shuttle program. The astronauts knew this more than anyone, of course, admits Chou, being made to suit up and sit in the orbiter for hours on end only to have an abort called; then they’d have to repeat the whole thing again two or three days later, still not knowing if the boosters would be lit or not. The volunteer Navy flight surgeons lost sleep and gas money driving to the base and back for aborted launches or landings that didn’t come to Edwards, but by comparison, theirs was no sacrifice. After all, even after being trained for the job as a volunteer there was a waiting list just for the opportunity to work a launch or a landing. That never changed.

Christmas, or other holidays. Christian Gelzer, recollections of shuttle pre-brief meetings at NASA Dryden.

³⁹⁰Chou, written recollections, email correspondence with Christian Gelzer, “Dryden’s Contributions to the Shuttle Program Notes.” NASA AFRC Historical Reference Collection.

12: The Orbiter Mock-up

Michael R. Chandler
NASA (ret.)
NASA Johnson Space Center

Abstract:

In order to prepare for worst case scenarios NASA arranged for the Air Force to design and build a full-scale mock up of the forward section of the space shuttle orbiter. Made of wood but entirely realistic, the mock up enabled rescue personnel to practice regularly for a variety of post landing accidents. How the mock up came about, and where it ended up being used and why, are part of this account.

Keywords:

Chanute AFB; Vandenberg AFB; Challenger; Modes; Fire

In 1984 the Department of Defense (DoD) Manned Space Flight Support (DDMS) office at Patrick Air Force Base was under the command of Col. Sniegowski; it was he who directed Capt. Michael Chandler, recently assigned to DDMS that year, the job of designing and building a shuttle orbiter mock-up / trainer to be used to train the fire/crash/rescue personnel at Vandenberg AFB, California, where the Air Force's shuttle was scheduled to launch in the future from the Standard Launch Complex Six (SLC-6). This assignment came with an additional task: locate funding for the mock-up. Chandler had recently arrived from Holloman AFB, NM, where he had been the Operations Officer for Detachment 6, 40 Air Rescue and Recovery Squadron (ARRS). His experience there, supporting the orbiter's landing site at Northrup Strip, NM, later known as White Sands Space Harbor (WSSH), provided him with the knowledge of what was required for the rescue operations and also provided him an opportunity to work with the Holloman AFB Fire Chief, Mr. Jerry Watts, with whom he consulted throughout the coming process.

Department of Defense Manned Space Flight Support was the DoD organization charged with coordinating NASA support and had authorization to coordinate within the DoD without going through normal chain-of-command channels. As a result, Chandler was able to work directly with personnel at various locations and at different levels not only within the DoD but also within NASA.

"I had no experience building a training mock-up," he recalled, "but through a series of discussions and teleconferences, I identified a U.S. Air Force Air Training Command (ATC) resource that had the project management experience building mock-ups that I needed and who and was willing to help me."³⁹¹ There, he connected with Mr. Schwartz and Mr. Tedesco, both civilians, who provided a draft document with all the right "how-to" terminology and requirements enabling him to write the requirements for the mock-up to train the fire/crash/rescue personnel. This material comprised one section of the overall document, with the rest of the technical information being provided by ATC. Chandler developed these requirements by consulting with the Air Force fire/crash/rescue training personnel, NASA fire/crash/rescue personnel, and the fire chiefs at Edwards and Holloman AFBs, all of whom had experience supporting the space shuttle program. After developing the first draft, he gave it to his superiors at DDMS. Col. Sniegowski was pleased with the plan (the assignment had previously been given to two other officers who "failed to even glue two pieces of wood together") and asked if Chandler could get this built.³⁹² He said yes, but still had to secure funds to pay for the project.

Chandler had a requirements document, a plan, and an ATC project manager: all he needed now was money. Since the mock-up was being built for Vandenberg AFB, he began his search there, with the organization that would be responsible for contingency operations when the shuttle launched from the west coast.³⁹³ After several discussions, the Vandenberg office agreed to provide up to \$250,000 for the trainer/mock-up. Now everything was in place to complete this project. Schwartz and Tedesco had already identified the personnel

³⁹¹ Michael Chandler, written recollections, email correspondence with George Grimshaw, January 2012, NASA AFRC Historical Reference Collection.

³⁹² Chandler, written recollections, email correspondence with Grimshaw.

³⁹³ The Air Force had invested heavily in its Space Launch Complex 6 (SLC-6) at Vandenberg AFB starting in the 1960s, and revived the launch site for the shuttle program in the 1980s, intending to use it for high inclination flights. NASA flew Enterprise to the site on the SCA for facility verification.

at Chanute AFB, IL, as the group that would do the design and development of the mock-up. (These were the people that built the miniature Air Force bases that were used to train Air Force fire chiefs.)

At Chanute, Roger White was designated as the Project Manager. He asked to come to the Johnson Space Center to review the Full Fuselage Trainer (FFT) and Crew Compartment Trainer (CCT) and to get the drawings he would need in order to develop a set of blueprints to use in developing the Vandenberg trainer/mock-up. This was an enormous task since these were blue line (not electronic) drawings; White had to borrow the drawings and have them physically copied. He also obtained information on the actual orbiters, then compared these drawings with the mock-ups to get the most authentic set of drawings possible.



The orbiter training mockup under construction at Chanute AFB. 022 Photo courtesy of Michael Chandler

One of the requirements Chandler had for this mock-up was to be able to place it in the vertical position (launch) configuration, as with the CCT, as well as in the horizontal position (landing), as with the FFT, since Vandenberg would accommodate both activities. An additional requirement he added was to be able to move the mock-up to different locations for training. While White was developing blueprints for the mock-up, Schwartz and Tedesco located a 40 foot flatbed trailer in a DoD reclamation yard and were able to withdraw it and have it reconfigured for use with the mock-up, making the training tool mobile.

By this time, Maj. Greg Stankie had joined the Training Section at DDMS and was assisting Chandler. The two had long teleconferences with the key players; they also visited the Chanute Training Facility, where the mock-up itself was being built. By then, White and his team had developed drawings and selected the marine grade plywood and other materials that would enable the mock-up to withstand the abuse it would endure through the fire/crash/rescue training, as well as the environmental conditions at Vandenberg. White even identified a special paint he planned to use to help with both the treatment and environmental conditions.

The key shuttle components required in the fire/crash/rescue training were identified in the DoD Manager's Space Transportation System Contingency Support Procedures Document, which Chandler also developed. In addition to the size (realistic overall dimensions), both the top and side hatches had to operate like those on the actual orbiter, to the degree possible. The procedures also required that the fire suppression switches

and the power-down switches in the orbiter mock-up be functional because the fire/crash/rescue personnel would be trained to operate them. The seats and harnesses were also important and needed to be as realistic as possible because the fire/crash/rescue personnel would have to release the harness and associated hardware (communications and oxygen connections) for each astronaut in case of an emergency. Seat number 5, for example, had to have a back that would release and move forward to allow easier removal of the crewmembers on the mid deck. Standard items that would just be in the way and hinder the fire/crash/rescue personnel were installed, but at a lower fidelity in order to maintain verisimilitude but keep costs down.

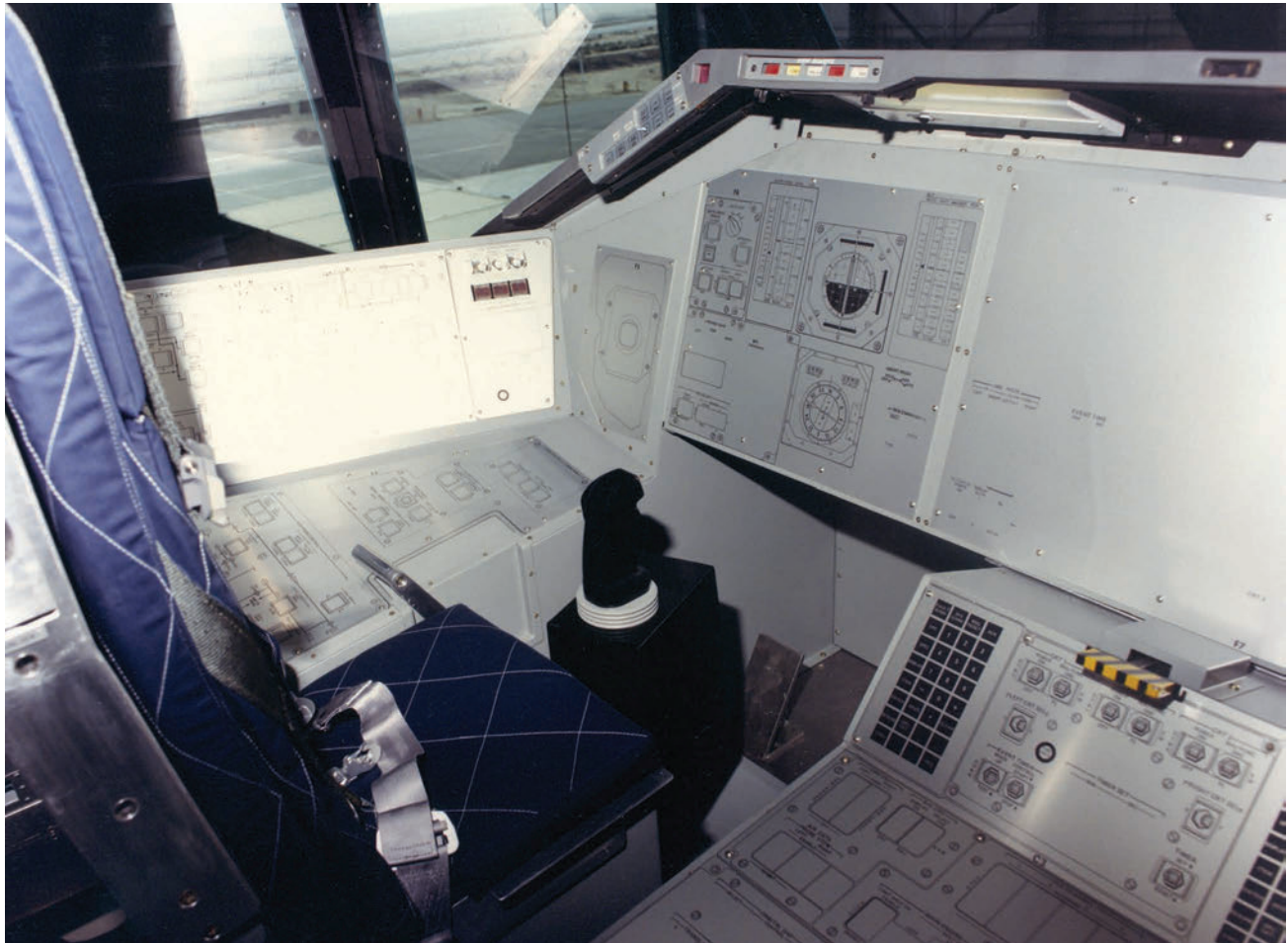

A view of the shuttle commander's seat in the orbiter mockup, showing the detail. 052 Photo courtesy of Michael Chandler

Things were moving along well with the mock-up in early 1986 when the Challenger accident happened, on January 28, 1986. Although the impact of the accident on the orbiter mock-up wasn't immediately apparent, as time went by things did become evident, chief among them the Air Force's decision not to acquire its own shuttle and therefore, not to launch from Vandenberg AFB. The orbiters themselves underwent a number of changes before they were returned to service. Meanwhile, several teams reviewed contingency operations resulting in numerous changes for consideration. Among the proposed changes was a bailout capability for orbiter crews, which required a gas pressure release mechanism to open the hatch. The mechanism would be included in the fire/crash/rescue personnel procedures, thus the controls to operate it also needed to be included. In the aftermath of the Challenger accident NASA considered two methods of escape from the orbiter (a rocket and a pole system for bailout), and White had to be able to incorporate either method into the completed mock-up. Meanwhile, a slide escape system was incorporated that worked with the hatch either intact or jettisoned.

Regarding the bailout capability, Joe Ramos, the Air Force Flight Test Center Program Manager for Shuttle Operations from 1987 to 1988, recalled: "A number of alternatives were looked at to include rocket-packs, but the final configuration was the simple pole that goes out of the side port hole of the shuttle. It was designed

[to be] long enough so that astronauts [could] hook up to it and, after jumping, they went under the wing.” Parajumpers from Naval Air Facility, El Centro, CA performed the initial jump tests instead of using dummies to validate the functionality of this system.³⁹⁴



The mid-deck storage area, starboard side. Although the cabinets did not open, the attention to detail—right down to numbering the on the cabinets themselves (a trademark of the craftsmen model makers at Chanute AFB), was critical for verisimilitude during training exercises. 059 Photo courtesy of Michael Chandler

After the decision to abandon plans to launch shuttles from Vandenberg, both the Kennedy Space Center (KSC) and Edwards AFB were considered as sites to locate the orbiter mock-up. Kennedy Space Center already had a functioning trainer, so the Air Force decided to place the DoD mock-up at Edwards in order to train DoD (Edwards and Holloman AFBs) fire/crash/rescue personnel there. This was before the mock-up had been delivered, making the decision a bit easier: Chandler and company didn't actually have to relocate it. Moreover, despite NASA's plans to land all of the orbiters at KSC following the first set of shakedown flights, the orbiters never managed to stay away from California, so keeping the crash and rescue people at Edwards trained in a realistic simulator turned out to be critical.

“After the Challenger accident,” wrote Ramos, “[the] DoD established the STS Contingency Support Office to get everyone trained for contingencies. One of the training tools was this Shuttle Trainer. [Crews] were trained to extract a fully suited astronaut while blindfolded to simulate saving an unresponsive astronaut in a smoke-filled shuttle.”³⁹⁵

As the orbiter mock-up neared completion, personnel at Chanute AFB, IL, planned a media day to show off the project. One of the highlights of the event was the participation of astronaut Steve Nagel, a colonel in

³⁹⁴ Joe Ramos, email correspondence with George Grimshaw, April 2012.

³⁹⁵ Ramos, email correspondence with Grimshaw.

the U.S. Air Force who came to Chanute to view the trainer and talk about how it would be used to enhance safety. White overheard Nagel telling his parents, who attended the event at Chanute, that being in the mock-up was as close as one could get to being in an orbiter, something White was very rightly proud of. [Nagel was also from Illinois and worked on crew escape following Challenger.]

On completion, the orbiter mock-up was disassembled, placed on 13 eighteen-wheeler trucks, and transported to Edwards AFB, where White and his team reassembled it. The mock-up then went through another functional checkout before being turned over to the ATC training personnel at the base. A small operations guide was provided, but there were very few copies. Chandler recalls, “it had instructions on the operations of the hydraulic lift, acceptable slope info, speed limits, and wind speed restriction for movement of the mock-up. The wind speed limit for moving the mock-up was 25 knots.” This could make moving the mock-up tricky at times at Edwards, where winds frequently blow at 30 and 40 knots, sometimes for days on end.

The mock-up was very successful in the training of fire/crash/rescue personnel, which would not have been possible without the suggestions and reviews of people like Henry Faint and George Hoggard, both of the KSC fire department; Jerry Watts, Holloman AFB Fire Chief; K.O. Smith of the Edwards AFB fire department; and MSgt. Joe Hughes and TSgt. Anthony (Tony) Young, ATC instructors who trained the fire/crash/rescue personnel not only at Edwards, but at locations around the world.

Chief William “Willy” Bell, of the Edwards AFB fire department was the AFFTC point of contact for receiving the orbiter mock-up.³⁹⁶ Once in service at Edwards, the mock-up was used for the remainder of the Shuttle Program, by the NASA/DoD Shuttle operations and contingency team in preparation for nominal and contingency landing support there.

The Edwards AFB fire department used the orbiter mock-up for training its fire/crash/rescue personnel for any shuttle landing contingency at the base. Col. Harry Talbot (Ret.), the Director of the Edwards Space Shuttle Contingency Response Team from 1994-2004, and who had managed post-landing towing operations for the Air Force before that, recalled: “The role of the Shuttle mock-up or shuttle trainer was to provide a realistic platform to train on and to demonstrate all the tasks necessary to recover the astronauts from the orbiter.”³⁹⁷ Brig. Gen. Jim Hogue (Ret.), Director, Edwards Space Shuttle Contingency Response Team, from 2004-2011, recalls: “NASA used it for docking training; I used it to develop procedures for landing on the temporary inside runway (22L/04R); the Army used it to train on positioning their helos in the correct spot during contingency exercises, in fact the entire team used the mock-up during contingency exercises to be in the correct position to perform their duties.”³⁹⁸

The mock-up was used during quarterly training exercises at Edwards, two of which were semi-annual, full-scale DoD contingency exercises held at Edwards to ensure the shuttle landing contingency support team was ready to support space shuttle landings in accordance with NASA’s standards.³⁹⁹ Detachment 3 of the DoD Human Space Flight Support Office (formerly the DoD Manned Space Flight Support Office) at Patrick AFB, FL, mandated these exercises as a safety requirement. During each exercise about 300 people from Edwards, March Air Reserve Base, Naval Medical Center San Diego, Naval Air Weapons Station China Lake, Fort Irwin, CA, Det. 3 and the Center participated, representing a host of professions, practicing orbiter nominal and emergency space shuttle recovery operations, all because the orbiter had very special handling requirements due to the toxic fuels that powered various systems. Often these exercises followed a week of training provided by NASA and Det. 3 personnel in the latest shuttle landing contingency procedures.

A few months before each exercise, Edwards and NASA shuttle landing support leaders began planning and coordinating the scenarios to be practiced. Typically, two of the four following landing contingency abort modes would be selected in developing the scenarios.

Mode V - unaided egress and aided escape, in which, after landing on the runway, the orbiter developed a problem such as smoke or fire and the astronauts could exit the orbiter but needed assistance from rescue personnel to get safely away from the vehicle.

Mode VI - aided egress and aided escape, which was similar to a Mode V; however, rescue

³⁹⁶ Ramos, email correspondence with Grimshaw.

³⁹⁷ Col. Harry Talbot (USAFR Ret.), written recollections, email correspondence with George Grimshaw, March 2012.

³⁹⁸ Brig. Gen. Jim Hogue (Ret.), email correspondence with George Grimshaw, April 2012.

³⁹⁹ Talbot, written recollections, email correspondence with Grimshaw.

personnel had to enter the orbiter, power it down and assist the astronauts in escaping from the orbiter.

Mode VII - landing off the runway, followed by aided egress and escape; similar to a Mode VI but with extra precautions because the orbiter landed somewhere other than on the runway.

Mode VIII - bailout: the crew had to escape the orbiter in flight and then be located and cared for by search and rescue personnel until more help could arrive.



Medevac personnel move an “injured” astronaut onto an HH-60 helicopter during a shuttle training exercise at Edwards AFB. NASA ED07-0094-07

An orbiter approach and landing was recreated for an exercise. NASA and DoD convoy elements were then staged for a nominal landing, with the orbiter mock-up as the focal point. Eventually NASA would declare a “Mode,” at which time the DoD shuttle contingency team would assess and safe the orbiter, then rescue and/or get the simulated astronauts safely away from the orbiter. Medical personnel would then determine the crew’s condition and prepare it for evacuation. The crew would be loaded into helicopters and flown to medical facilities at Loma Linda Medical Center or UCLA. Usually, once the helicopters were close to the medical facilities the exercise would end. Following each exercise, de-briefings were held to discuss lessons learned.⁴⁰⁰

The orbiter mock-up needed periodic renovation, including upgrading the seats and connectors, making repairs in response to years of use and exposure to the harsh desert elements, and giving the mock up a fresh coat of a special paint to protect it for years to come.⁴⁰¹ Following the Columbia accident in 2003, the mock-up underwent a major renovation.⁴⁰² There being no requirement for the mock up to be used in the vertical position at Edwards (the launch position), that capability was removed and the mock-up was locked in the horizontal position.

The orbiter mock-up remained at Edwards AFB until the program ended, in 2011, and is preserved at the Air Force Flight Test Museum at Edwards AFB.⁴⁰³

⁴⁰⁰ George Grimshaw, “Supporting Shuttle - 35 Years of Excellence at Dryden,” p. 16. November 2012. https://www.nasa.gov/sites/default/files/atoms/files/supporting_shuttle_dryden.pdf, accessed May 31, 2018.

⁴⁰¹ George Grimshaw and Larry Biscayart, Oral Recollections, April 2007, NASA AFRC Historical Reference Collection.

⁴⁰² Talbot, written recollections, email correspondence with Grimshaw.

⁴⁰³ George Grimshaw, correspondence with Christian Gelzer, March 2012, NASA AFRC Historical Reference Collection.

Troubleshooting

13: Enterprise: Pilot-Induced Oscillation

Peter W. Merlin

JT3

Edwards Air Force Base

ABSTRACT:

The last free-flight of Enterprise ended with an unexpected pilot induced oscillation (PIO) and multiple touchdowns on the runway. An investigation followed, both at Kennedy Space Center and at Armstrong Flight Research Center (AFRC). At AFRC the Digital Fly-By-Wire F-8 airplane served as the testbed since its primary flight computer was the same as that used on Enterprise: an IBM AP-101. Different tests led to a filter installed in the programming that reduced pilot gains in a PIO situation.

KEYWORDS:

Enterprise; Fred Haise; Gordon Fullerton; Pilot induced oscillation (PIO); IBM AP-101; F-8 Digital Fly-By-Wire; Lunar Landing Research Vehicle (LLRV); Calspan Total In-Flight Simulator (TIFS); Rate limiting; Phase lag



Commander Fred W. Haise (l) and C. Gordon Fullerton in the cockpit of Enterprise in preparation for the last free flight of the orbiter. NASA EC77-8858

Throughout the free-flight (FF) series of the Approach and Landing Tests (ALT) in 1977 the orbiter OV 101 Enterprise performed well mechanically and structurally. But on the final free-flight (FF), something

unexpected happened revealing the orbiter's susceptibility to pilot-induced oscillation (PIO), prompting NASA engineers to develop a work around to the problem before the first orbital flight test (OFT).

The free-flights came in fairly quick succession: the first on August 12, the second and third on September 13 and 23, and the fourth on October 12, 1977. OV-101's fifth free-flight was set for October 26 of that year.

Aboard Enterprise for FF-5 were Fred W. Haise and C. Gordon Fullerton: the two were making their third free-flight as part of the ALT. Haise came from the Apollo program and was making a return to Edwards AFB and the Center, to which he'd transferred as a NASA research pilot in 1963. "I was asked if I would consider being a member of the Apollo-Soyuz crew," he recalled in 1999, speaking of the period following his time as a back-up crewmember on various Apollo missions and flying on Apollo 13. "I felt I could do the Agency better because of my past experience and Edwards experience with ... some winged re-entry vehicles, that I could serve better by skipping that and going on to shuttle."⁴⁰⁴ Fullerton came to NASA from the Air Force by way of the Manned Orbiting Laboratory (MOL), a program cancelled before it left the ground. Transitioning to NASA's astronaut corps, he'd served as part of the support crew on Apollo 14, 15, 16, and 17, but had not yet flown in space.⁴⁰⁵ Both had taken active, critical roles in designing elements of the space shuttle orbiter; both were graduates of the Air Force's Aerospace Research Pilot School (1964 and 1965 respectively), what was once, and by 1972 again became the Air Force Test Pilot School.

FF-5 Flight and Landing

17,600 feet (5.364 km) above ground level (AGL): Haise and Fullerton released the 75-ton space shuttle orbiter Enterprise from the shuttle carrier aircraft (SCA) while flying at 245 knots equivalent airspeed (KEAS).⁴⁰⁶ On a straight-in approach to runway 04, the 15,000 foot (4.572 km) concrete runway with a lakebed overrun, the two pilots began preparing for a quick descent to the main runway: without the tailcone the orbiter had less flying time than with the fairing on. As Enterprise approached the Edwards main runway, Fullerton adjusted the orbiter's attitude in order to increase airspeed to 290 KEAS. Meanwhile, Haise made left rudder and roll inputs before deploying the speed brakes to collect a set of aerodynamic data points. The orbiter's speed brakes were split rudders, an element derived from the X-15.

9,600 feet AGL (2.93 km): Haise and Fullerton intercepted the glideslope.

7,000 feet AGL (2.13 km): Haise assumed control of the speed brake.

4,000 feet AGL (1,219 m): the crew noticed that they had drifted above the glideslope.

To reacquire the aim point and prevent overspeed, Haise pitched down and deployed the speed brakes to 80%. Responding to a momentary 10-knot airspeed decrease, he closed the speed brakes slightly. Fullerton noted an airspeed decrease to 275 knots followed by a rapid increase to 290 knots.

2,000 feet AGL (610 m): the orbiter was on a slightly steeper trajectory than planned but still aligned with the aim point. The indicated airspeed was now 294 knots (four knots higher than planned) and the orbiter was 600 feet (183 m) closer to the runway threshold than planned for that point in the flight. Haise delayed retracting the speed brake to compensate for the excess speed, but to no avail: there was a seven-knot tailwind.

As the crew lowered the landing gear, Enterprise approached the runway threshold at the correct altitude but now carried an extra 20 knots of airspeed. Haise set the speed brakes to 50%, anticipating that the orbiter would slow at touchdown, but the speed remained high: the orbiter was now doing 200 knots as it quickly

⁴⁰⁴ Fred W. Haise, Jr. Interviewed by Doug Ward, Houston, TX – March 23, 1999, Johnson Space Center Oral History Project.

⁴⁰⁵ Half of the 14 astronauts from the Manned Orbiting Laboratory program, which was cancelled in 1969, took NASA's offer to join its astronaut program and went on to fly as shuttle commanders, pilots or mission specialists. Truly and Fullerton were part of this group.

⁴⁰⁶ *Test Agency Report ALT GN&C Certification for Free Flights 4 and 5, Volume II, Separation*, (Rockwell International Space Division: Contract NAS9-14000 IRD SE-639T and RA-281T2, December 1977), p. 14.

A sample of descent rates (elapsed flight time and altitude) of the flight:

52:49—16,879 feet

52:57—15,809 feet

53:04—14,154 feet

53:09—13,038 feet

Rosemary Killen, *Shuttle Program ALT Space Shuttle Program Barometric Altimeter Altitude Analysis*, NASA TM 7952, (Houston, TX: NASA Johnson Space Center, 1978), p. a-26.

approached within 500 feet (152.5 m) of the touchdown line. To guests and other observers Enterprise seemed to float across the runway threshold and then down the runway at an altitude of four feet (1.2 m).⁴⁰⁷



Enterprise makes a typical steep shuttle approach to the main runway at Edwards for its final free flight. Despite this remarkable glideslope, the orbiter will still make the runway as planned. NASA EC95-43116-26

Haise attempted to correct a roll motion and applied forward stick to force the orbiter down to the runway, to no effect. Instead, the orbiter floated up before touching down smoothly some 1,000 feet (305 m) beyond the planned point and at a speed of 180 knots - then skipped into the air and rolled to the right. As Fullerton tried to level the wings, a lateral pilot induced oscillation (PIO) developed.⁴⁰⁸ As the oscillations continued, the crew realized that the roll commands through the hand controller were abnormally large and the response was lagging: because of the rate-saturated pitch channel, the flight control system priority rate-limiting design did not allow response to some roll inputs. Pitch had priority, and the priority logic of the hydraulic system locked out any roll commands, triggering the large roll delay at touchdown and the subsequent PIO. By releasing the controller momentarily, Haise allowed the motions to damp out naturally just prior to the second touchdown.⁴⁰⁹

About six seconds after skipping into the air, Enterprise touched down a second time. The crew was forced to accept a higher-than-normal sink rate because of concern about airspeed bleed-off to 155 knots. Consequently, the orbiter landed harder than planned. The left main wheel lifted slightly on the rebound but quickly settled onto the runway.⁴¹⁰ Remarked Haise years later:

The landing gear people were somewhat chagrined through most of that test program because we were not landing hard enough to get them good data for the instrumentation they had on the landing gear struts. I solved their problem on the fifth flight [when] I landed on the

⁴⁰⁷ "Space Shuttle Orbiter Approach and Landing Test – Final Evaluation Report," JSC-13864.

⁴⁰⁸ Each crew station in Enterprise was equipped with identical rotational hand controllers. In pitch, the controller pivoted about the palm of the hand; in roll, it pivoted about a point slightly below the base. The two controllers were not mechanically linked, but if both were deflected the input signals were combined and the elevons responded accordingly. During the final eight seconds prior to touchdown the pilot's inputs to control sink rate caused an unexpected pitch oscillation. The orbiter's control system software limited the elevon rate to 26 degrees per second in order to cope with hydraulic flow limits for the elevon actuators. Because the system gave priority to pitch inputs, the flight control system failed to respond quickly to some roll inputs, resulting in four seconds of pilot induced oscillation.

⁴⁰⁹ Milton O. Thompson, notes on "Sequence of events on FF-5 landing," n.d., File Folder L1-5-2-2, Milton O. Thompson Collection, NASA AFRC Historical Reference Collection.

⁴¹⁰ "Space Shuttle Orbiter Approach and Landing Test – Final Evaluation Report," JSC-13864.

runway and bounced the vehicle, and my second landing was about 5 or 6 foot a second [1.5-1.8 m/s]. That gave them the data, and they were very happy with that—although I wasn't.⁴¹¹

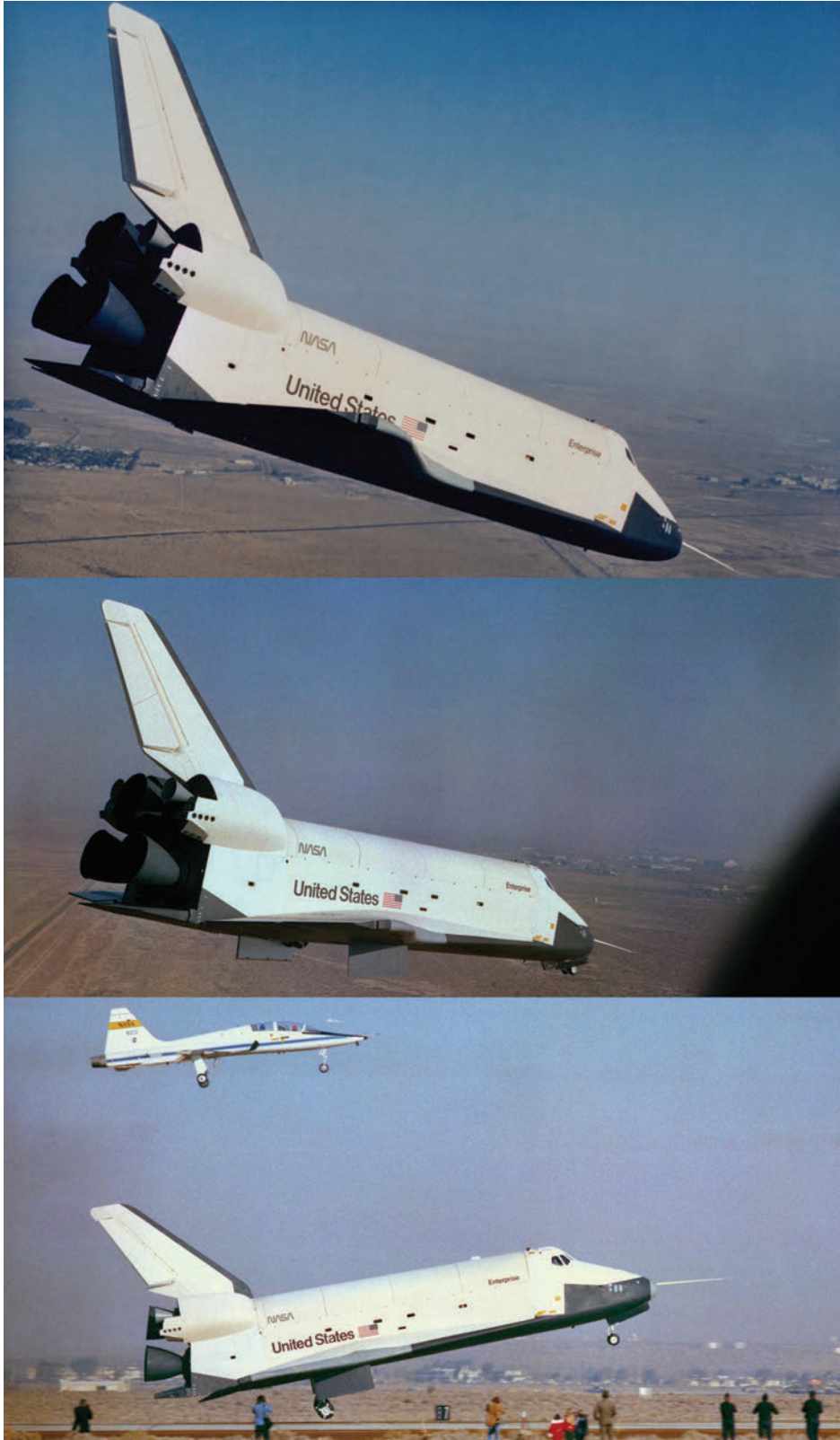

The orbiter's steep angle of descent is apparent here, typical of all orbiters as they bleed off speed and make use of the very last of their remaining energy in order to reach the runway. The shuttle trades altitude for velocity to gain distance, much like a lifting body. NASA EC77-9058, EC77-9036, EC77-9038

⁴¹¹ Haise, interviewed by Ward, Houston, TX – March 23, 1999, Johnson Space Center Oral History Project.

Flight time from 17,600 feet (5.364 km) to wheel stop was 2 minutes 1 second. The total runway rollout distance from the initial touchdown: 7,930 feet (2.417 km).⁴¹²

The landing was entirely surprising and this flight was well attended. For this flight selected VIPs were taken by bus to a viewing site relatively close to the base's main runway. Among those watching all this unfold was Great Britain's Prince Charles, himself a pilot.⁴¹³ Analysis of the data from FF-5 indicated the PIO resulted from control stick inputs made during the last eight seconds prior to touchdown. Pilot inputs to control the sink rate resulted in a sequence of large elevon deflections ahead of touchdown. This over-rotation caused the orbiter to skip back into the air. Haise was unaware of any problem beyond the fact that he was landing long, and he applied forward stick pressure to halt the ballooning, inadvertently initiating a roll command, possibly due to the unusual control stick geometry (the stick longitudinal axis is inclined to the axis of the orbiter). Because the center of pitch motion was near the cockpit, normal acceleration cues were lacking during the small pitch oscillations. Also, due to cockpit visibility limitations, small changes in pitch attitude were not readily apparent to the crew. Consequently, neither crewmember detected the oscillation that caused elevon rate limiting.⁴¹⁴

Engineers at the Center launched an all-out effort to understand and solve the Enterprise PIO problem. In early 1978 "Milt" Thompson, director of the Center's Research Projects branch, drafted a plan to "obtain a current database that will sharpen our awareness of all factors (subtle and obvious) that might influence a low L/D orbiter runway landing in demanding situations." Part of the program called for application of ALT data to computerized simulators for the purpose of familiarizing shuttle pilots with the gain settings for landing. At the same time, the Center's F-8 Digital Fly By Wire (DFBW) testbed – an ex-Navy Vought F-8 Crusader fighter jet with highly modified flight controls – provided flight-test data to determine how delayed computer response to human input might be reduced or eliminated.⁴¹⁵

In the early 1970s Center engineers and mechanics modified one of the F-8 Crusaders into the first pure Digital Fly-By-Wire aircraft in existence, removing all of the hydraulic mechanical control systems in the aircraft and substituting a fly-by-wire control system. Those on the project drew heavily from the Lunar Landing Research Vehicle (LLRV) experience; it was with this aircraft and its analog fly-by-wire controls that they developed confidence in the concept. The engineering team considered an analog computer for the project but discarded it in favor of a digital system, a move with profound implications for commercial and military aviation. When Melvyn E. "Mel" Burke and Calvin R. "Cal" Jarvis went to NASA headquarters seeking funding for the project, they admitted that they had no viable digital computer around which to build the project. One of their first stops was the Office of Advanced Research and Technology (OART), where they met with Neil A. Armstrong. He, like some others at HQ, was keen to see technology from the Apollo program transferred to industry, and quickly endorsed the plan. But, admitted Burke and Jarvis, they had no suitable digital computer. Armstrong, not long returned from Apollo 11 and serving as the Deputy Associate Administrator for Aeronautics, pointed to the Apollo Guidance Computer (AGC) as the solution. It was one of these computers that they integrated into the F-8's flight control system to make it the DFBW F-8. The AGC, which at the time of its creation was the best small, portable digital computer in existence, had a total

⁴¹²Jenkins, *Space Shuttle: The History of the National Space Transportation System*, p. 211. The flight had an aggregate descent rate of roughly 8,800 feet per minute or 141.5 feet per second; in fact, the descent rate of the orbiter was, at times, higher than this. In one section of the approach a simulation showed it descending just over 5,000 feet in the space of one horizontal mile for Free Flight 5 (FF-5); that simulation began with the orbiter separating from the SCA 8.5 miles from the runway. *Test Agency Report ALT GN&C Certification for Free Flights 4 and 5, Volume II, Separation*, (Rockwell International Space Division: Contract NAS9-14000 IRD SE-639T and RA 281T2, December 1977), A-31, A-32. There was no actual time history data for FF-5.

⁴¹³Recalled Joe D'Agostino, Dryden's Shuttle Program Manager: "The lift-off was nominal, nothing to speak of. Separation went well - I could listen on a radio. It was nominal. You're focusing, trying to focus on two jobs. You want to be a spectator but at the same time you're caught up in your job, security in my case. And then, as the vehicle approaches it looks like it's a little hot. Then I see the first bobble: 'That ain't in the program.' The second turn actually occurs almost directly in front of the VIP area, and you're saying 'oh no.' Your mind is already preparing for the worst and you're hearing some of the conversations you're not supposed to hear. I don't know what the exact words were but I always remember, 'get off the stick, get off the stick,' and then the vehicle levels out and goes down the runway. The prince looks around and you know he knows something is wrong. Nobody knows the answer at that point and then we start talking about pilot induced oscillation." Joe D'Agostino, oral history interview, Armstrong History Office, NASA AFRC Historical Reference Collection.

⁴¹⁴"Space Shuttle Orbiter Approach and Landing Test – Final Evaluation Report," JSC-13864.

⁴¹⁵Milt Thompson, handwritten briefing chart, "DFRC Flight Investigation of Factors Affecting Orbiter-Type Landings," [n.d.], and "Features of Candidate A/C for Landing Program," [n.d.], Milton Thompson Collection, 438 439, NASA AFRC Historical Reference Collection.

memory of 38K.⁴¹⁶ Both Mercury and Gemini had fly-by-wire control systems, albeit analog, making the U.S. space program the first to employ such systems (none of the spacecraft had mechanical backups). But the modification of the F-8 into a pure fly-by-wire testbed was the first digital system to fly on an air.

Over time, newer, more capable computers were installed as the program advanced, finishing with an IBM AP-101. “The AP-101s were the first flight-qualified “IBM 360s.”⁴¹⁷ They were remarkable machines, and they enabled the F-8 DFBW to be successful because of what could be done programming them, even though they had serious hardware problems. “We had a lot of computer failures on the ground,” recalled Ken Szalai, an engineer on the fly-by-wire project and eventually Center Director. “We just couldn’t keep three computers running. It all worked out, but we would not have said this at the time. My hair turned gray.”⁴¹⁸ Central to the AFRC role in solving the PIO problem was the fact that the space shuttle orbiter flight computers also were IBM AP-101s.

Although the F-8 DFBW was not “an early player” in the resolution to the PIO problem, it proved central to the solution. “The problem was solved by a small group [at the Center] that included John Edwards and John Smith. Smith is a patent holder on the PIO-suppression filter.”⁴¹⁹ That filter flew in the orbiter to the very end. The pilot could select predetermined values for various flight parameters using an input keypad that had been used on the Apollo 15 lunar mission (a Display and Keypad or DSKY), linked to an AP-101 computer. The F-8 itself was not inherently prone to PIO: in order to evaluate a suppression filter Center engineers imposed a programmed time delay in the control system. For safety reasons the pilot was given the ability to activate and deactivate the control delay from the cockpit (the DSKY was accessible only from a panel on the side of the fuselage).⁴²⁰

Five research pilots flew PIO data flights, making a total of 60 landings to simulate the orbiter’s control characteristics. They found that lags as short as 200 milliseconds between pilot input and discernible control surface response profoundly affected handling qualities. At the PIO condition, rate limiting decreased system gain, introducing phase lag into the system.⁴²¹

The solution was a software filter that “reduced pilot gain[s] in a PIO situation” without affecting handling qualities or causing control time delays.⁴²² The filter detected the onset of PIOs and reduced the control stick gains automatically. This removed the pilot from the loop to some degree, damping his inputs and negating the otherwise inevitable series of ever-increasing oscillations. These software changes worked, reducing, if not entirely eliminating, PIO tendencies. Greater landing control, however, came at the expense of some degree of control-stick responsiveness.⁴²³

In fact, much the same problem surfaced on the very first all fly-by-wire aircraft ever flown - the LLRV on October 30, 1964, also at Edwards AFB. Designed as a six-degrees-of freedom free flight simulator, the LLRV was the research vehicle meant to seat the parameters for the training vehicle the Apollo astronauts

⁴¹⁶ Tomayko, *Computers Take Flight*, p. 31. NASA contracted with Draper Labs of MIT for the Apollo Guidance Computer (AGC) and ultimately 75 computers were built. <http://ed-thelen.org/comp-hist/vs-mit-apollo-guidance.html>, accessed March 15, 2012. The AGC was a hard-wired digital computer, programmed by changing small magnets on each wire (positive or negative) to achieve 0s or 1s.

First flight of the digitally controlled F-8 came on May 25, 1972 and the impact of the project was swift: General Dynamics flew the first digital fly-by-wire F-16 on January 20, 1974. Airbus flew an A320 in February, 1987, the first pure digital fly-by-wire commercial aircraft.

There were precursors to the DFBW F-8 and LLRV but they were neither digital nor all-computer controlled. The X-4 and the Avro CF-105 had electronic control of only one surface and retained hydraulic mechanical systems.

⁴¹⁷ Ken Szalai, interview with James Tomayko, June 8, 1998, NASA AFRC Historical. Reference Collection.

⁴¹⁸ Szalai, interview with James Tomayko.

⁴¹⁹ Szalai, interview with James Tomayko. “You could not redesign the whole shuttle system at that point,” said Szalai, who was an engineer on the program and eventually Center Director. “They’d just finished the last major flight control hardware tests on the shuttle [and] no one wanted a fix that would take hundreds of thousands of hours of vehicle verification and validation. If you start playing around with the closed-loop controls it would cost a lot of money and cause a big upset in the program.” See also John W. Smith, and John W. Edwards, *Design of a Nonlinear Adaptive Filter for Suppression of Shuttle Pilot-induced Oscillation Tendencies*, NASA TM-81349, (Edwards, CA: NASA Dryden Flight Research Center, 1980).

⁴²⁰ M. F. Shafer, R. E. Smith, J. F. Stewart, and R. E. Bailey, “Flight Test Experience with Pilot-Induced Oscillation Suppression Filters,” NASA TM 86028, (Edwards, CA: NASA Ames-Dryden Flight Research Facility, 1984).

⁴²¹ J. W. Smith, “Analysis of a Longitudinal Pilot-Induced Oscillation Experienced on the Approach and Landing Test of the Space Shuttle,” NASA TM-81366, (Edwards, CA: NASA Dryden Flight Research Center, 1981).

⁴²² The changes came at the cockpit end, specifically at the control stick. There, engineers changed the “stick shape,” another way of saying they changed the gains.

⁴²³ Gorn, *Expanding the Envelope*, p. 353.

would use to practice lunar descent and landing before doing it in the Lunar Module (LM). On the first flight that cold October day, a number of things didn't go as planned, although Joe Walker landed safely. In the debrief he noted "while he had little difficulty maneuvering about the yaw axis, it seemed nearly impossible to prevent inadvertent inputs with the center stick in pitch and roll." He'd detected a problem endemic to virtually all subsequent fly-by-wire aircraft for some time to come, including the YF-16, shuttle, and the Swedish Viggen: "The problem resulted from excessive pilot controller sensitivity, which had not manifested itself during any of the numerous simulations carried out during the design and evaluation of the LLRV. It appeared only during critical flight-test maneuvers requiring high levels of pilot workload and concentration, such as takeoffs and landings, particularly during first flights." The LLRV team solved the problem by reducing the controller sensitivity, something later termed changing the "stick shape."⁴²⁴

The Flight Research Center conducted additional studies in 1978 with the Air Force's Calspan Total In-Flight Simulator (TIFS), a highly modified C-131H transport aircraft (military version of the Convair CV-240 family of airliners, dubbed Convairliners). The results characterized deficiencies in the low altitude longitudinal handling qualities of the orbiter, which contributed to pilot inability to precisely control flight-path angle and altitude change rate, predict aircraft response to control inputs, and adequately control the vehicle in disturbances due to external forces such as wind gusts. Robert G. Hoey, et al., "Flight Test Results from the Entry and Landing of the Space Shuttle Orbiter for the First Twelve Orbital Flights," AFFTC-TR-85-11, Office of Advanced Manned Vehicles, Edwards, CA, June 1985.⁴²⁵

The objective of the TIFS flight research was to evaluate orbiter handling qualities with various proposed mechanizations of the flight control system. The flight-test program was designed to replicate the ALT FF-5 flight control problem and develop control system modifications to be incorporated into the orbiter Columbia (OV-102). Center engineers planned a series of flights to first replicate the ALT FF-5 conditions, then simulate a nominal Orbiter Flight Test 1 (OFT-1) baseline configuration and variations of OFT-1 with alternative transport lag, surface rate limit, and forward-loop pitch gain. Other variables included use of a conventional stick controller and simulation of a cockpit moved 40 feet farther forward.⁴²⁶

Eight NASA research pilots (including five eventual shuttle astronauts) flew 16 two-hour flights in the TIFS, completing 155 approaches (78 actual and 77 simulated). Flight conditions included both actual and simulated air turbulence.⁴²⁷

A model-following accuracy and test technique developed during the TIFS simulations provided useful data for assessing pilot performance in potentially off-nominal situations. The primary evaluation that the pilots (one each from the Flight Research Center and JSC) flew simulated and actual touchdowns in the OFT-1 baseline configuration for all tasks investigated. Interestingly, only 15% of the approaches received satisfactory handling qualities ratings from the pilots. Of the rest, 70% were rated unsatisfactory; 15% were considered unacceptable due to the unforgiving longitudinal control characteristics of the orbiter. Pilots with minimal or no prior experience with orbiter flight simulations had severe difficulty landing because they could not perceive deviations and make corrections to the flight path quickly enough. With extreme concentration, more experienced pilots found it easier to note deviations and avoid the need for large flight-path corrections. Additionally, they were able to develop a pulsing control technique to minimize rate-limiting problems.⁴²⁸

Pilots found the orbiter's PIO tendencies considerably more noticeable in flight tests than in ground simulations. Based on the level of their experience, the TIFS evaluation pilots decided they wanted a well-damped but more responsive airplane. Engineers achieved this, to some degree, by increasing the pitch forward-loop gain and allowing unlimited elevon surface rates. (Some evaluation pilots noted improved handling qualities when the cockpit was "moved" 40 feet forward of the center of pitch-rotation.)

⁴²⁴Matranga, Ottinger, Jarvis, with Gelzer, *Unconventional, Contrary, and Ugly*, pp. 84-85. The term allows engineers to distinguish the modification at the control stick from changing the gains at the control surfaces. For the orbiters, this meant altering the results of the control inputs via computer programming to avoid saturating the control system computer, doing so at the control stick instead of the control surface. Smith and Edwards, *Design of a Nonlinear Adaptive Filter for Suppression of Shuttle Pilot-Induced Oscillation Tendencies*, pp. 1, 3-4, and Gorn, *Expanding the Envelope*, p. 353.

⁴²⁵Robert G. Hoey, et al., "Flight Test Results from the Entry and Landing of the Space Shuttle Orbiter for the First Twelve Orbital Flights," AFFTC-TR-85-11, Office of Advanced Manned Vehicles, Edwards, CA, June 1985.

⁴²⁶C. R. Chalk, and P. A. Reynolds, "Test Plan – Simulation of Orbiter Landing Characteristics in the USAF Total In-Flight Simulator (TIFS)," Calspan Corporation, TIFS Memo No. 844, May 25, 1978.

⁴²⁷"TIFS Program Summary," File Folder L1-5-2-2, Milton O. Thompson Collection, NASA AFRC Historical Reference Collection.

⁴²⁸"DFRC Orbiter Landing Investigation Team Final Presentation," August 1978. File Folder L1-5-7-22, Milton O. Thompson Collection, NASA AFRC Historical Reference Collection.

Additionally, the conventional center stick provided improved control compared to the rotational hand controller.⁴²⁹

Using data obtained from fixed-base and in-flight simulations, engineers developed reasonably effective PIO suppression filters for use on Columbia for its first flight. Because the software revisions merely mitigated, but did not completely eliminate, the orbiter's latent PIO tendencies, engineers at the Center continued to study the problem into the 1980s (well after the first OTFs).

Development of the space shuttle orbiter produced the first reusable spacecraft capable of returning from orbit and landing on a conventional runway. This bold, pioneering effort forced engineers to confront complex challenges in developing a vehicle with the longitudinal flying qualities required for landing the orbiter manually in an operational environment. The ALT program was the final hurdle before the first orbital mission. Based on ALT flight data and orbiter crew evaluations, all objectives of the program were successfully accomplished. The orbiter's aerodynamic performance and loads were as predicted by wind tunnel testing and computer analysis. During FF-5 the orbiter roll response was found to be less than expected due to rate limiting, leading to follow-on research to correct the PIO problem.⁴³⁰

Engineers determined that the orbiter had two modes affecting longitudinal control. The first mode involved the effective time delay between pilot input and vehicle response in pitch attitude control. As on most aircraft, the mechanical control actuators contribute a significant delay (hysteresis), as do the structural and smoothing filters that are required because of the high gain feedback control system. The digital flight control system also contributes delays because of the average sampling time and computation time. A nonlinear control stick gearing provided good sensitivity around the neutral stick position while retaining a good maximum pitch rate or normal acceleration capability, but it also contributed to the orbiter's pitch attitude PIO tendencies. The second mode was altitude or flight-path control. Loss of lift caused by elevon deflection caused a nose-up pitch command to result in a downward acceleration at the center of gravity. Because the cockpit was near the center of rotation there was a 0.5-second delay before the pilot detected the motion. The sluggish rise time of the acceleration to its steady-state value, combined with delayed perception of motion, made it difficult for the pilot to accurately control attitude. High cockpit location and poor forward visibility also contributed to the pilot's inability to judge both attitude and altitude near touchdown.⁴³¹

The PIO suppression filter designed following the DFBW and TIFS investigations was added to the orbiter's flight control system software prior to OFT-1/STS-1. Although the filter virtually eliminated high-frequency PIO tendencies, it was not designed to improve low frequency, large-amplitude heave mode characteristics near touchdown produced by poor flight path control. Nevertheless, orbiter crews had no significant high-frequency PIO problems during the first 12 OFT landings. Extensive simulator training for orbiter pilots prevented all but a few isolated incidents of over-control tendencies over the shuttle's history. Autoland was used on STS-3 (the third OFT flight) all the way through the landing flare. The pilot then took over for manual landing and experienced a hard touchdown because he perceived and reacted to a "heave mode" (positive pitch change) that had not, in fact, occurred.⁴³²

As director of the Center's Research Projects branch and an experienced research pilot himself (he'd flown the X-15 and lifting bodies, among other things), Milt Thompson had reservations about the orbiter's flying qualities. He admitted that the software changes offered improvements in the orbiter's handling qualities and safety, but still felt that problems with the vehicle's flight control system existed and needed to be resolved. In late 1980, just a few months before Columbia's maiden flight, Thompson shared his feelings with a colleague at JSC: "I would improve the landing control system as soon as possible. Real handling quality improvements in the landing control system would eliminate the need for the PIO training. The PIO suppressor does not improve the handling qualities during landing. [It] is simply a crutch which does not address the real problem. I do not feel the entry handling qualities are as good as they should be...[and] should be improved before the Shuttle becomes operational."⁴³³

⁴²⁹ "DFRC Orbiter Landing Investigation Team Final Presentation." See also Smith and Edwards, *Design of a Nonlinear Adaptive Filter for Suppression of Shuttle Pilot-induced Oscillation Tendencies*, NASA TM-81349, (Edwards, CA: NASA Dryden Flight Research Center, 1980).

⁴³⁰ "DFRC Orbiter Landing Investigation Team Final Presentation."

⁴³¹ B. G. Powers, "Low-Speed Longitudinal Orbiter Flying Qualities," *Space Shuttle Technical Conference*, NASA CP-2342, Part 1, (Houston: NASA Johnson Space Center, 1983), pp. 143-150.

⁴³² Hoey, et al., AFFTC-TR-85-11, and comments of C. Gordon Fullerton while reviewing a draft of this paper.

⁴³³ "Space Shuttle Support," 1-2, Milton Thompson Collection, NASA AFRC Historical Reference Collection, cited in Gorn,

Prior to OFT-1, however, NASA officials concluded the orbiter could safely fly at subsonic speeds down to landing. Flight research and analysis had verified that the handling qualities were sufficiently understood and that the crew could accomplish a safe return from orbit. For their exceptional efforts, the four Enterprise crewmen received the Kincheloe Award from the Society of Experimental Test Pilots.⁴³⁴ An analysis of flight-test results from the first 12 orbital shuttle missions by the AFFTC Office of Advanced Manned Vehicles concluded: “Presently, the Orbiter’s insidious subsonic longitudinal handling qualities are considered acceptable considering the scope of the current STS program which relies heavily upon the skills of a relatively small and specially trained crew of astronauts.”⁴³⁵ Air Force analysts felt that the orbiter’s handling difficulties were the result of vehicle configuration design rather than control system deficiencies. They recommended that future spacecraft designers conduct simulator investigations on the effects of cockpit location with respect to the longitudinal center of rotation of the vehicle.

Columbia (OV-102) launched into space for the first time on April 12, 1981. After completing a two-day orbital checkout, the crew (John Young and Robert Crippen) successfully landed on the Edwards dry lakebed, ushering in a new era in spaceflight. Three more orbital flight test missions were flown before NASA declared the orbiter operational. The fleet grew to include Challenger (OV-099), Discovery (OV-103), and Atlantis (OV-104). Enterprise (OV-101) continued to serve as a ground-based testbed for structural dynamics and fit-check verification tests. After the loss of Challenger in 1986, a replacement orbiter, Endeavour (OV-105), was built. Due in large part to the resources and efforts of engineers and pilots at the Center, the orbiter fleet entered service with control problems better understood and rendered entirely manageable.

Over the course of 30 years the space shuttle orbiter fleet made 133 successful landings from orbit. Of these, 54 took place at Edwards AFB. One mission, STS-3, ended with a landing at Northrup Strip (now White Sands Space Harbor), NM. The remaining 74 landings took place at KSC, on Merritt Island near Titusville, FL. Without question the ALT program paved the way for this remarkable record of achievement. Said Robert Kahl:

I think after almost 36 years the real heroes that need to be recognized on the Shuttle program were the pilots, the astronauts that flew Enterprise for its first separation flights. Without validating it and taking it up, separating from the 747 and gliding it for the first time into the dry lakebed at Edwards—not knowing that it was going to glide, that the flight controls and the brakes were going to work and it was going to stop, and do all the things that it was supposed to do—the astronauts and the missions we’ve flown and the [International] Space Station is all great, great stuff, but without that first ALT team and Fred Haise, Gordon Fullerton, Bob Crippen—those guys are the ones that really set the scene for the things that we continue to do today.⁴³⁶

Expanding the Envelope, pp. 353-354, 439.

⁴³⁴ Hallion, *Test Pilots*, p. 274.

⁴³⁵ Hoey, et al., AFFTC-TR-85-11, Office of Advanced Manned Vehicles, Edwards, CA, June 1985.

⁴³⁶ Robert H. Kahl, interviewed by Rebecca Wright, Downey, California – 25 August 2010. NASA STS Recordation Oral History Project, Edited Oral History Transcript. http://www.jsc.nasa.gov/history/oral_histories/STS-R/KahlRH/KahlRH_8-25-10.htm, accessed January 23, 2012

14: Shuttle Tire Tests

Christian Gelzer and Christopher Nagy
Logical Innovations, Inc., and NASA (ret.)
NASA Armstrong Flight Research Center

Abstract:

The explosion of a space shuttle orbiter main landing gear tire upon landing at KSC was extremely hazardous since there were only two tires per side. An investigation pointed to the grooved, very rough runway at KSC as the culprit, and the runway was extensively modified to reduce wear on the tires. AFRC engineers proposed a flying tire testbed that could lower a shuttle tire onto the runway at different yaw angles to see the results; it was approved. The results showed that the new shuttle tires did not have the expected durability, reducing the number of landings and the amount of crosswind they could endure.

Keywords:

STS-51D; Tire explosion; Langley Aircraft Landing Dynamics Facility (ALDF); Convair CV 990 Land Systems Research Aircraft (LSRA); Bob Baron; Ken Szalai

“Bang!”

STS-51D (Discovery), the 16th space shuttle mission, concluded with a landing at the Kennedy Space Center (KSC) following a seven-day flight, almost to the minute, on April 19, 1985. The crew of seven included United States Senator E. Jacob “Jake” Garn (Utah). At touchdown the orbiter weighed just over 198,000 pounds (89,811.3 kg) - one of the lowest weights of a returning shuttle to that point. This was the fifth time an orbiter had landed at the KSC. On rollout, the inside tire of the right main landing gear failed. While engineers had found unexpectedly high tire wear on previous landings, the tire failure on 51D’s landing shocked them.⁴³⁷

As commander Karol “Bo” Bobko flew the shuttle’s approach to the KSC runway he dealt with a light crosswind coming from 90 degrees averaging 7.8 knots, and 4.5 knot tailwind. Main gear touchdown was at 209 knots. All four main gear tires were new, while the nose gear tires were on their third flight.⁴³⁸ Despite the side force on Discovery, Bobko brought the orbiter down without incident. At very nearly the end of the rollout the inside tire on the right main gear exploded. “The whole orbiter shook—I thought one of the fuel tanks had blown up,” recalled Jeffrey Hoffman, a mission specialist on the flight.⁴³⁹

The orbiter was initially designed to meet several landing requirements, including landing on a 12,500-foot (3.81 km) runway with crosswinds of up to 15 knots. Based on dynamometer and tire wear testing performed at the Langley Research Center, Rockwell International certified the orbiter for landing with up to 20 knots of crosswind. Shuttles had a landing speed of roughly 200 knots and an anticipated sink rate of just over nine ft/sec (2.74 m/sec), although both the actual landing speed and sink rate varied from mission to mission. The shuttle’s brakes were initially made with a high beryllium compound because of that material’s capacity for high heat transfer, and the compound seemed quite promising at first. Tires on the main gear originally had 3/8” tread, underlain by 16 cords, or layers. (Reference to the ply of the tire—34 on the original tires—is not directly connected to the number of cords.) Each orbiter main truck assembly had two tires and “simulation studies showed that the second tire would fail shortly after the first tire” either from shrapnel or from the sudden assumption of a double load, “leading to the loss of the vehicle.” Failure of both tires could send the orbiter veering into one of the drainage ponds on either side of the KSC runway -- a catastrophic ending to a flight.⁴⁴⁰

⁴³⁷ Christopher J. Nagy and John F. Carter provided essential input, review, and corrections to this article.

⁴³⁸ “Memorandum CB-85-437: STS-51D Flight Crew Report,” Johnson Space Center, p. 40. The highest crosswind an orbiter endured on landing was 10.9 knots. Dennis R. Jenkins, email correspondence with Christian Gelzer, May 26, 2011. “Dryden’s Contributions to the Shuttle Program Notes.” NASA AFRC Historical Reference Collection.

⁴³⁹ Jeffrey Hoffman, *16.885J Aircraft Systems Engineering*, Fall 2005. (Massachusetts Institute of Technology: MIT OpenCourseWare), <http://ocw.mit.edu>, accessed May 19, 2011. License: Creative Commons BY-NC-SA. See also “STS 51D National Space Transportation Systems Program Mission Report, May 1985,” JSC 20570.

⁴⁴⁰ John Carter and Chris Nagy, notes to the author on the LSRA history, June 3, 2011, in the NASA AFRC Historical Reference Collection. One reason for the use of beryllium was weight: “selecting beryllium for the [Lockheed] C5A’s 24 brakes saved about 1600lbs.” Norman S. Currey, *Aircraft Landing Gear Design: Principles and Practices*, (Washington, D.C.: American Institute of

At the time of this landing the orbiter's nose gear was marginally steerable, with a deflection from center of just +/- 9 degrees. Unlike many of the orbiter systems, the nose gear steering was single string; in deference to the lack of redundancy in the steering system, shuttle commanders were reluctant to use it at all lest the hydraulic controls fail while the tires were deflected. Instead, commanders and pilots preferred differential braking with the main landing gear as the means of steering the orbiter during rollout.⁴⁴¹

There were several contributing factors to the blown tire - the only time a shuttle tire failed during a landing - and the crosswind seemed a minor one, particularly since it did not approach the maximum allowable for a shuttle landing. The strength of the crosswind on this landing led Bobko to apply greater braking force to the right main gear than the left in order to bring the shuttle back on track once it was on the runway. Post-flight analysis indicated that the orbiter's main wheels touched down left of the runway centerline; on initial rollout the shuttle had a slight leftward trajectory until the nose wheel touched down, after which that modest trajectory became a strong pull to the left. At the point of greatest divergence, the orbiter was a bit more than 58 feet off of the runway centerline before the commander began guiding it back to the right, where it reached the centerline. Bobko then made another, milder, correction to the left to keep the orbiter on the centerline, where it remained until wheels-stop. Not surprisingly, the brakes on the right truck assembly heated to higher than expected temperatures.⁴⁴² Despite all this, it wasn't the heat that caused the tire to fail, even if it could be chalked up as a contributing factor along with the crosswind. Investigators concluded that the largest contributing factor to shuttle tire wear in general—and to this tire's explosion—was the surface of the KSC runway, the Shuttle Landing Facility (SLF).

As a result of studies done by NASA as early as 1968, there had been a push to carve transverse grooves into runways to shed water during heavy rain, allowing aircraft greater contact with the surface and so more control on landing.⁴⁴³ NASA studies conducted at the Agency's Wallops Island Flight Center were the impetus for the introduction of grooved runways at airports in the U.S. Using a McDonnell F-4D Phantom and a NASA Convair CV-990, pilots made repeated landings on the single runway at Wallops, in differing conditions. The pilots found that

transverse-groove surfaces drastically reduced all types of skids on a wet or flooded runway and provided positive nose-gear steering during the landing roll out. The grooved surfaces also prevented the onset of drift and weathervaning. The overall airplane ground handling and stopping characteristics on the grooved surfaces showed a dramatic improvement over those on corresponding un-grooved surfaces with no observable adverse characteristics from the pilots' point of view.⁴⁴⁴

The KSC single runway, the SLF, was built in the mid 1970s and took full advantage of the research conducted at Wallops Island. The SLF runway had the transverse grooves, but it also had “an extremely rough longitudinally-brushed texture” when compared to other runways. The design requirement for the SLF was to allow the orbiter to land in a three-inch-per-hour rainstorm, which led to a deeply grooved runway whose

Aeronautics and Astronautics, 1998), p. 148. But beryllium, while an excellent material for heat transfer, is also especially toxic when atomized. <http://www.mdguidelines.com/toxic-effects-beryllium>, accessed May 10, 2012.

⁴⁴¹ A memo from the astronaut's office warned about the consequences of tire failures: “Our new “hot” nosewheel steering system has nine single-point hydraulic or electric failures that result in NO nosewheel steering.” Memorandum CB-86-001, January 6, 1986, JSC, from CB/Chief of Astronaut Office to CA/Director, Flight Crew Operations, Re: Use of the Shuttle Landing Facility as the End-of-Mission Landing Site—Is the Risk Worth the Gain? AFRC Historical Reference Collection.

⁴⁴² The orbiter brakes were rated for 36 million foot-pounds for normal use and a maximum-abort rating of 55 million foot pounds. The brakes had failed at 42.6 million foot-pounds during STS-5's landing, and during STS 51D's landing the right-hand brakes experienced 41 million foot-pounds. Forty-eight seconds after their engagement, the right-hand brakes failed. This and reference to the orbiter landing path appear in “STS-23 (51D) tire article,” internal document, NASA AFRC Historical Reference Collection, p. 6.

⁴⁴³ Fred J. Drinkwater III, Maj. Clark Price, and James M. Patton, Jr., *Research Pilots*’ “Observations of Aircraft Performance on a Grooved Runway,” *Pavement Grooving and Traction Studies*, (NASA: Washington, D.C.), NASA SP-5073, 1969; see also Donald W. Smith, Frederick G. Edwards, John D. Foster, and Fred J. Drinkwater III, “Flight Tests of an Automatic Approach and Landing Concept for a Simulated Space Shuttle Represented by the NASA Convair 990 Aircraft,” May 1, 1974. Dryden made an early if involuntary and unconscious contribution to the runway grooving study at Wallops when the 1963 Pontiac Catalina which the Center acquired and had modified to tow the M2-F1 lifting body across Rogers Dry Lake for the early tests, was sent to the barrier island facility when it was no longer needed at Dryden, where it was used for wet runway tests.

⁴⁴⁴ Drinkwater, Price, and Patton, Jr., *Research Pilots*’ “Observations of Aircraft Performance on a Grooved Runway,” p. 119.

surface had a very rough texture.⁴⁴⁵ NASA's research also "led to the adoption of grooving on military and civilian airport runways and public highways."⁴⁴⁶

Based on tests by the tire maker, BFGoodrich, each tire was embossed with "maximum six landings." In the company's tests the sixth landing was a worst-case scenario, leading some responsible for the shuttle tires and landing gear to expect only one landing given that the next one might be a worst-case and possible fail.⁴⁴⁷ The orbiter's high landing speed and sink rate, combined with the severe roughness of the runway surface, meant that a landing on the SLF almost always took divots out of the orbiter's tires. Consequently, the shuttle program found that the tires could sustain only one worst-case landing (based on speed, load, and crosswind) at KSC, and since one never knew whether or not the next landing would be a worst-case scenario, a new set of main gear tires had to be used for each flight.⁴⁴⁸

Any landing of a high speed aircraft takes a toll on the tires, but the combination of the orbiter's sink rate and high speed, and its low number of wheels (the four landing gear trucks on many commercial airliners—sometimes eight tires per wing plus another pair in the center body—were not an option for the shuttle, so it was limited to two tires per side) to absorb the landing forces, crosswind, and very rough runway surface—exacerbated by the flight crew's preference for differential braking over nose wheel steering—eventually became more than one of the main gear tires could handle.⁴⁴⁹ Moreover, investigators found that wear spots on the main tires worsened with any cornering during rollout, either because of a crosswind or from pilot steering.⁴⁵⁰

Customarily, shuttle crews walked around the orbiter after landing, examining it with their eyes and hands, surveying the damage while marveling at the machine that survived the intense heat and stress of an orbital re-entry. Not this time: the shuttle crew, along with shuttle recovery ground personnel were removed from STS-51D's proximity lest another of the tires blow out.⁴⁵¹ Tire pressure on the orbiter's main gear ran between 340 pounds per square inch (psi) to 410lb psi (1.51 kN to 1.83 kN/6.45 cm sq), typically averaging 370 psi (1.65 kN/6.45 cm sq): under the circumstances, each tire was a potential bomb.⁴⁵²

Although NASA planned to land future shuttles at KSC, weather permitting, program managers promptly decided that all subsequent shuttle landings would be at Edwards / Flight Research Center until they could resolve the matter of the blown tire.⁴⁵³

The Johnson Space Center, which oversaw the shuttle program activities at this level, was anxious to see the episode closed and the shuttles return to landing in Florida. This goal meant committing to the tests that would

⁴⁴⁵ C. D. Michalopoulos and David A. Hamilton, *Orbiter Tire Traction and Wear*, SAE Technical Paper Series, 95201, September 1995, 1, and Robert H. Daugherty, Thomas J. Yager, and Sandy Stubbs, *Shuttle Landing Runway Modification to Improve Tire Spin-Up Wear Performance*, SAE Technical Paper Series, 881402, October 1988, p. 2. This was long before research on shuttle tires, conducted at Dryden, put an end to any notion of ever flying an orbiter through any known moisture, let alone heavy precipitation.

⁴⁴⁶ *A History of Significant Research at NASA Langley's Aircraft Landing Dynamics Facility*, [n.a.], (NASA/XX-2008-XXXXX), October 2008, 29, unpublished internal manuscript.

⁴⁴⁷ Jenkins, note to Christian Gelzer.

⁴⁴⁸ Hoffman, *16.885J Aircraft Systems Engineering*, Fall 2005. The comments were made by the visiting guest lecturer, Allen J. Louviere, who, while working for NASA at the Johnson Space Center, rose to the position of Assistant to Director of Engineering, Shuttle Crew Escape System. Louviere's career at NASA spanned from the Gemini program to the International Space Station.

⁴⁴⁹ The orbiter's negative angle of attack (AOA) after the nose rotated past level on touchdown made this worse. With its ultimate -4.5 degrees AOA on nose wheel touchdown, "aerodynamic loads apply a tremendous pressure on the tires and gear." Jenkins, *Space Shuttle: The History of the National Space Transportation System*, p. 219.

⁴⁵⁰ "Rollout distances varied from a minimum of 6,015 ft. [STS-28 on Rwy 17 at Edwards] to 13,732 ft. [STS-3 at White Sands]. The average rollout distance was 9,188 ft. Variations [were] based on conditions [such as] weather, winds, orbiter weight, sink rate, [and] landing speed." George Grimshaw, email correspondence with Christian Gelzer, April 5, 2012. "Dryden's Contributions to the Shuttle Program Notes." NASA AFRC Historical Reference Collection.

⁴⁵¹ Louviere, in Hoffman, *16.885J Aircraft Systems Engineering*, Fall 2005.

⁴⁵² ALDF engineers calculated the energy in a hot tire to be the rough equivalent of 2½ sticks of dynamite.

⁴⁵³ A prime concern in the planning stages of the space shuttle was the ability of the orbiter to execute a Return To Launch Site abort should, for example, one or more space shuttle main engines (SSMEs) fail before the ascending orbiter achieved enough momentum and altitude to make a Transoceanic Abort Landing (TAL). "The performance penalty when an engine loses thrust or completely fails is directly related to the time of the problem." Should a failure happen early in the shuttle flight, when it was heavy with both propellant and payload, the failure could make achieving orbit difficult if not impossible. Exactly when this would happen determined where the shuttle would then go—Abort Once Around (AOA) with a landing at Edwards/Dryden, White Sands/Northrop Strip, KSC, or possibly continue the mission. There was even a contingency for an East Coast Abort Landing (ECAL), implemented to accommodate high-inclination launches. Jenkins, *Space Shuttle, The History of the National Space Transportation System*, pp. 263-265.

answer the questions at hand, tests JSC was in no position to conduct itself. For this it would have to rely on its sister Centers with relevant experience and capabilities. The first to begin tests was the Langley Research Center. There, engineers began running shuttle tires down the test strip at the Langley Aircraft Landing Dynamics Facility (ALDF), a structure designed specifically to test tires under various conditions and loads. With an 1,800-foot (548.6 m) track, a rail structure to move a tire down the track at varying speeds and under different loads, and with the ability to vary the surface of the track and to inundate the track with water to change conditions, the ALDF was the best aircraft tire test laboratory facility in the nation. A much-improved test system over the original Landing Loads Track that was first put into use in 1955, the ALDF nevertheless had its own limitations. The most significant was that the ALDF was limited to an 1,800-foot rollout, meaning that a complete touchdown to wheels stop orbiter landing could not be simulated. Engineers later learned that the inability to simulate the heat buildup in a tire during a full orbiter landing was a significant drawback as well. Additionally, the ALDF had a maximum test run of 5 seconds at 220 knots, the highest speed attainable on the track, and a maximum vertical weight loading on a tire of 65,000 pounds (29,483.5 kg) at 200 knots.⁴⁵⁴ Still, the test track provided a chance to test the effects of the KSC deeply grooved and very rough runway on a shuttle tire that had been spun up to mimic landing speeds.

From these initial tests Langley engineers concluded that the prime culprit in both the unexpectedly high tire wear rates and the actual tire failure on STS-51D was the SLF surface. Having put down deep runway grooves on the ALDF for the tests, they now took hammers—literally—and hammered down a patch of their test runway and then performed another spin up and landing test. They found that the smoothed but still grooved runway—dubbed “corduroy” for the now-rounded top of the grooved surface—helped mitigate the severity of the spin-up patch on the tires while sacrificing none of the water shedding ability of the original transverse grooving.⁴⁵⁵

To validate this finding, the Langley group created the Instrumented Tire-Test Vehicle, (ITTV) a heavily modified truck that carried equipment to run various tires under moderate loads at different angles relative to vehicle’s direction and braking conditions. The ALDF engineers drove the ITTV over the touchdown area of the SLF to study the ways in which different runway textures affected an aircraft tire (they did not use a shuttle tire, and ITTV speeds were limited to about 35 miles per hour [56.3 km/hr]). The engineers also performed yaw tests on a rolling T-38 tire at low speeds. The ITTV could not test shuttle tires in actual flying and weight conditions, creating a void of information. In the end, Langley researchers concluded that increasing the orbiter’s crosswind capability from 15 knots to 20 knots would require a 100% increase in the side load strength of the orbiter tires—something for the tire manufacturer to contend with.

The Langley engineers’ next step was to modify the first 3,500 feet (1,067 m) at both ends of the SLF by shot-peening this portion of the runway, this time using an industrial machine. Inasmuch as the spin-up of the shuttle tires, the most violent moment in the tires’ use, took place on this patch of runway, it was this section which the Langley team addressed.

Given the limitations of the ALDF at this point, additional testing took place at the Flight Dynamics Laboratory, part of the Wright Aeronautical Laboratories at Wright Patterson AFB, in Dayton, OH. Because Air Force jets land at high speeds and high loading, the Air Force Laboratory had a high-speed drum against which instrumented test tires could be rolled under varying loads. This was where the shuttle tires had been initially tested and certified. “Tire dynamometer facilities roll aircraft tires against a metal drum at any combination of velocity, vertical load, and slip angle. These facilities have the advantage of long run times, very good load and speed control, and good control of the slip angle of the tire.”⁴⁵⁶ But, it turned out, the drums could not accurately mimic runway surfaces, their curvature led to an inexact contact area that altered the radial tire deflection during contact surface runs, and heat buildup in the drums during test runs led to abnormally high surface temperatures that skewed tests results.⁴⁵⁷ As a result, the shuttle program managers felt there was more to the tire problem than these two facilities could help to define.

Meanwhile, there were eight more launches after STS-51D until the program abruptly halted with the loss

⁴⁵⁴ *A History of Significant Research at NASA Langley’s Aircraft Landing Dynamics Facility*, pp. 7, 9.

⁴⁵⁵ *A History of Significant Research at NASA Langley’s Aircraft Landing Dynamics Facility*, pp. 3, 5. Also Daugherty and Yager, *Texture Modification of the Shuttle Landing Facility Runway*, p. 2.

⁴⁵⁶ John F. Carter and Christopher J. Nagy, *The NASA Landing Gear Test Airplane*, (Edwards, CA: NASA Dryden Flight Research Center, June 1995) NASA TM 4703, p. 2.

⁴⁵⁷ Carter and Nagy, *The NASA Landing Gear Test Airplane*, p. 2.

of Challenger, STS-51L, on January 28, 1986.⁴⁵⁸ What followed was a 32 month down time while the Agency and its contractors examined procedures and equipment in an effort to return the orbiters to flight. The focus was on propulsion, but the time enabled the program to address other things as well, such as instituting full nose wheel steering, new and much more capable tires, and installing a drag parachute that had once been planned for the orbiters. Return-To-Flight came on September 29, 1988, but that flight, like the next ten, landed on the runway in the California High Desert. STS-38, however, on November 15, 1990, was diverted to KSC because of deteriorating weather at Edwards AFB, marking the first landing back at the Cape since 51D, in 1985. Nevertheless, KSC still was not designated the prime landing site because of lingering concerns about the tire problems.

The Landing Systems Research Aircraft

Stories abound of great ideas hatched in a bar late at night; the Landing Systems Research Aircraft (LSRA) is one of these.⁴⁵⁹ Engineers and managers at JSC started brainstorming over ways to generate good tire test data. What they wanted was a device capable of duplicating the landing gear loads of a touchdown-to-wheels-stop orbiter landing. By this time the problem seemed to be less the runway surface, which many in the shuttle program were relatively satisfied had been resolved with the work done by Langley, than other unknowns. What the Flight Research Center proposed, and what the LSRA represented, was a flying testbed to explore and understand a number of topics that the engineers could not adequately examine any other way. These topics included not only the growing weight of the orbiters but their descent rates at touchdown; the effect of initial spin up on tires at touchdown on the modified runway surfaces of the SLF; and side forces imposed by crosswinds, by drift after runway contact or steering demands once the nose wheel touched down, by the runway surface itself, and by heat due to friction on the initial spin up at touchdown and during rollout. The engineers discussed options and drew pictures on napkins and eventually a rough design for a large aircraft with an orbiter landing gear mounted in some sort of trapeze emerged. Because of the aircraft expertise available at the Center, JSC approached individuals at the Center about developing such an aircraft. Based on a presentation given to Robert “Bob” Crippen, then Deputy Director, Shuttle Operations, in May 1988, the engineers anticipated a project with the following objectives:

Primary:

- Obtain drag forces on all shuttle landing surfaces for nominal rolling wheel and tire.
- Obtain drag forces on all shuttle landing surfaces for a single tire failure.
- Obtain drag forces on all shuttle landing surfaces for dual failed tires, wheels, and dragging gear strut.
- Obtain drag forces on all shuttle landing surfaces for roll on rim and skid designs.

Secondary:

- Determine orbiter brake/antiskid performance for single and dual tire failure cases.
- Determine brake/antiskid strut dynamic interaction effects during normal and failure cases.
- Examine nose gear normal and tire failure cases.
- Determine main strut and nose gear side forces as a function of tire slip angle.

Additional:

- Determine main gear tire wear characteristics as a function of tire slip angle.⁴⁶⁰

⁴⁵⁸ A memo from the Chief of the Astronaut’s Office dated January 6, 1986 announced that future shuttle landings would use Edwards AFB, except for those intending to land at Vandenberg AFB. It dryly warned: “If the Orbiter, as a result of crosswinds, its landing gear, blown tires, nosewheel steering problems, and/or flight crew failure, leaves the runway at the Shuttle Landing Facility, NASA will discover why the Air Force requires its runways to have stabilized shoulders.” Memorandum CB-86-001, January 6, 1986 Re: Use of the Shuttle Landing Facility as the End-of-Mission Landing Site—Is the Risk Worth the Gain?

⁴⁵⁹ In contrast, the Propulsion Controlled Aircraft concept was hatched by NASA engineer Frank “Bill” Burcham aboard a TWA flight en route to St. Louis. Taking a cocktail napkin, he sketched out the schematic for controlling an aircraft solely with propulsion. See Tom Tucker, *Touchdown: The Development of Propulsion Controlled Aircraft at NASA Dryden*, (Washington, D.C.: NASA, 1999), Monographs in Aerospace History #16, p. 1.

⁴⁶⁰ Carter and Nagy, notes on the LSRA, June 3, 2011. “Dryden’s Contributions to the Shuttle Program Notes.” NASA AFRC Historical Reference Collection.

In light of future events, it was significant that the tire wear objective was included, and was envisioned as a test conducted with fixed tire slip angles.

The next step was to obtain funding for the project. A team including Drum Simpson from JSC and Bob Baron from the Flight Research Center made a presentation to Arnold “Arnie” Aldrich, then the Director of the Shuttle Program Office, to explain the need for the project. They finished by asking for \$3-6 million to get started. Aldrich was trying to allocate funding among all the projects then requesting money and, because he was planning on spreading money across several budget years, asked what could be done for an initial investment of \$1.5 million. Baron, thinking to start the negotiations, replied that no significant work could be accomplished for that amount. The team was aghast to hear Aldrich simply say, “OK, next.” The JSC managers, much more familiar with Aldrich than Baron, pulled the latter from the room, went back in and hastily arranged another meeting with Aldrich later that night. They emerged from that second meeting with an agreement to start the project for \$1.5 million.⁴⁶¹



The CV-990 LSRA at Dryden. This angle highlights the aerodynamic shock pods on the wing’s trailing edge necessary to reduce drag and allow the aircraft to reach its maximum operating speed. NASA EC92-057275-30

With at least seed money on the way, the next step was to find a suitable aircraft for the project. It needed to be big and heavy, capable of both replicating the orbiter’s landing speeds and actual landing weights, and at the same time carrying a structure to hold a shuttle tire that would be lowered onto the runway and yawed for tests. At the time the Flight Research Center was an adjunct facility to the NASA Ames Research Center, and Ames had a Convair CV-990 that by then mostly sat idle. Ames acquired the aircraft from Modern Air Transport, intending to modify it into an airborne observatory, the Center’s first CV-990 having been destroyed in a mid-air collision in 1973. (That aircraft had been used at one point to fly low L/D approach and landings specifically for the shuttle program.)⁴⁶² The second NASA CV-990 (also based at Ames) burned to

⁴⁶¹ Carter and Nagy, notes on the LSRA, June 3, 2011. “Dryden’s Contributions to the Shuttle Program Notes.” NASA AFRC Historical Reference Collection.

⁴⁶² Berwin M. Kock, Fitzhugh L. Fulton, Jr., and Fred J. Drinkwater III, *Low-Lift-To-Drag-Ratio Approach and Landing Studies Using a CV-990 Airplane*, NASA TN D-6732, March 1972. On April 12, 1973, N711NA, the CV 990 operated by Ames (the very first airframe of this type built), collided with a U.S. Navy P-3B on approach to Moffett Field, killing all on board both aircraft (6 in the CV-990, 5 in the P-3). *Aviation Safety Network*, <http://aviation-safety.net/database/record.php?id=19730412-1>, accessed September 7, 2011.

the ground after a landing gear tire failed during takeoff from March Air Force Base in 1986.⁴⁶³ The current CV-990 was the third type in Ames' inventory and served as a flying Spacelab simulator for a period.⁴⁶⁴ Now the Center was asking for it to do, of all things, landing gear tests that threatened to involve tire explosions and possibly fires not unlike that which destroyed Ames' second CV-990. Yet the request was approved and the Center had its flying testbed, the Landing System Research Aircraft.⁴⁶⁵

The Design Unfolds

The design of the LSRA was broken into three segments:

1. The modifications to the CV-990 to accept the test landing gear;
2. The structure and hydraulics systems necessary to raise and lower the landing gear to provide vertical loading; and
3. The "systems" part of the aircraft, consisting of the computers and software necessary to provide commands to the hydraulics and onboard displays, the instrumentation necessary to obtain test data, feedback loops for system control, and telemetry for real-time ground displays.

Based on expertise available at the Flight Research Center, program managers decided to contract out the first two tasks and perform the third task in-house. In April 1989, managers generated a request for proposal for the first two tasks and turned it over to PRC Inc. (a Center engineering support contractor at the time) for procurement. Modifying the aircraft for these tests would be no trivial task, since the CV-990 was 30 years old and the original Convair Division of General Dynamics that designed and built it no longer existed. Moreover, what the task required was shocking: in order to accommodate a structure large enough and strong enough not simply to hold the shuttle tire but to be capable of raising and lowering it, steering it for yaw tests, and forcing it down onto the runway surface to increase the load on the tire, the keel of the CV 990 would need to be cut—tantamount to cutting out a section of human spine and splicing in a cage to replace the lost segment. NASA had never cut an aircraft's keel before.

Few were surprised when only Sandaire Aircraft Engineering Co., from San Diego, CA, responded to the request for quotes: this company consisted primarily of CV-990 structural engineers who had once worked for Convair Aircraft Company. The contract was let to Sandaire in July 1989, and after the firm augmented its staff with some hydraulics specialists, their design work began. The Conceptual Design Review was finished in August of that year.

Meanwhile, Bob Baron, the project manager for the LSRA, began assembling a team to design and build the systems portion of the testbed. His team comprised primarily Center civil servants, with a few support contractors supplied by PRC, Inc., notable among them a subcontractor called High Plains Engineering led by Ralph Smith and Chris Nagy, which officially had the responsibility for designing the control computers and associated software. As the project took shape it became apparent that no one was really performing the role of systems engineer (in this case the task of making sure the customer's requirements were met while at the same time overseeing the integration of all the various systems). Sensing this void, Smith and Nagy unofficially stepped in.

While Sandaire worked up its proposed design for the changes, the CV-990 arrived at the Flight Research Center.⁴⁶⁶ The team, along with the project pilots, decided to make eight baseline flights with the aircraft to establish pilot familiarity with the unmodified aircraft, generate data on the CV-990's brakes, thrust reversers, and spoilers, and set performance values that could be compared with the aircraft after modification.⁴⁶⁷

⁴⁶³ In the second CV-990 accident two tires on the right main gear blew out during takeoff from March Air Force Base, CA, and the crew aborted the takeoff. During rollout, debris, either from the tires or from the wheel and brake assembly penetrated the underside of the right wing, puncturing the right wing fuel tank. "Leaking fuel ignited while the aircraft was rolling and fire engulfed the right wing and fuselage." This time the entire complement on board escaped unharmed. *Accident Aircraft Report: NASA 712, Convair 990, N712NA, March Air Force Base, July 17, 1985, Executive Summary*. (NASA, Washington, D.C. 1986), p. 2.

⁴⁶⁴ *NASA/ESA CV-990 Spacelab Simulation (ASSESS II)*, A Joint Endeavor by the National Aeronautics and Space Administration and the European Space Agency, [n.a.], July 1977.

⁴⁶⁵ The sordid joke at Dryden was that when anyone asked Dale Compton, the Ames Center Director, about CV-990s he immediately thought about burning aircraft.

⁴⁶⁶ CV-990, N710NA, arrived at Dryden from Ames on March 6, 1989 with Gordon Fullerton at the controls; Bill Dana flew chase in an F-104 as the pair made a fly-over salute to the Center. The "Daily Log" kept in the pilots' office at Dryden was a record of each day's flights by specific aircraft and pilot (sometimes even with departure times and remarks about the weather), periodically with marginalia. Daily Log, L1-9-71989, NASA AFRC Historical Reference Collection.

⁴⁶⁷ The next time the CV-990 flew was on September 9 of that year, by which time its registration had been changed to N810NA,

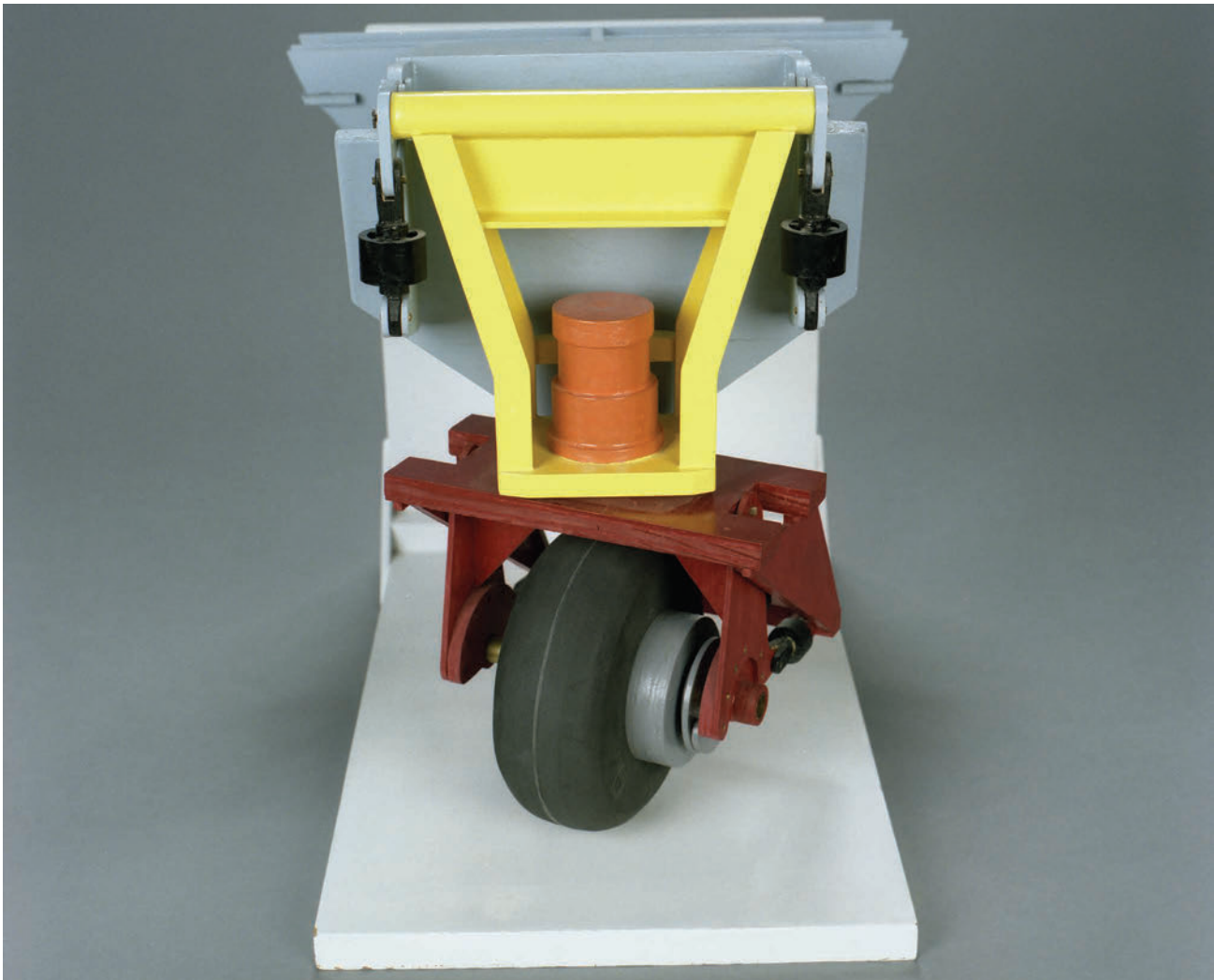

The steering mechanism mock-up that allowed the shuttle tire to be yawed on rollout. Although not part of the original proposal, this feature reduced the amount of flights necessary. NASA EC95-42935-02

The completed baseline flights provided data that would later be of great value in planning flights safely and efficiently, but these flights were not without incident. The first flight came with project pilot C. Gordon “Gordo” Fullerton in the left seat. Fullerton had considerable experience with large and heavy aircraft, having flown the type for the Air Force as well as for NASA over the years. He was also a former shuttle pilot and commander.⁴⁶⁸ The first flight ended with a smooth, normal landing. During the landing on the second flight, Fullerton handed the controls to the co-pilot, Steve Ishmael, whose main experience was with fighter aircraft.⁴⁶⁹ About 100 feet (30.5. m) off the ground the aircraft went through several cycles of pilot-induced oscillation in roll. Nagy was monitoring the flight from an instrumentation van parked at mid-field of the base’s main runway and his first thoughts were that the project was going to be over before it began and he was going to be a prime witness to an aircraft accident. Fullerton later explained that the response was not unusual for a fighter pilot when flying a large aircraft for the first time.⁴⁷⁰

reflecting the Center that now had responsibility for the aircraft. Between then and January 23, 1990 it would fly 10 more times, all with Fullerton as chief pilot while two other pilots took turns in the right seat: Steve Ishmael and Bill Dana. On September 26, while Fullerton and Ishmael were flying the CV-990, Dana was at the controls of NASA 840, a highly modified F-18. During the flight, he inadvertently jettisoned the canopy, turning the F-18 into a convertible and promptly aborting the flight. Three days later he and almost all the other Center’s pilots travelled to Los Angeles to attend the annual Society of Experimental Test Pilots meeting, of which they were members.

⁴⁶⁸ Fullerton joined the astronaut corps during the Apollo program but did not fly in space until the shuttle, on which he played essential roles. Prior to joining NASA he’d been a bomber pilot in the USAF and graduated its Air Force Research Pilot School, today’s Test Pilot School. During his time at JSC he flew the KC-135 “Vomit Comet,” used for zero-g parabolic flights.

⁴⁶⁹ The “Daily Log” indicates this to be Steve Ishmael, although the Center’s reference collection does not have that pilot’s personal logbook to verify this. Daily Log L1-9-7 and L1-9-8B, 1989 and 1992, NASA AFRC Historical Reference Collection,

⁴⁷⁰ When a fighter pilot initiates a roll command with the cockpit yoke in a transport category aircraft the expectation is of an

During the initial design, an issue arose over the installation of a rotary actuator to steer the test wheel in order to yaw the tire during landing rollout. The original objective called for force and wear tests using a tire at a fixed steering angle. The rotary actuator was initially conceived merely as a way to speed up testing. The original plan was to manually rotate the tire to the desired test condition and then pin it at that angle; when it needed to be changed, the aircraft would have to stop and the ground crew would have to rotate the tire and then re-pin the actuator for the next test. Several engineers, led by Smith, wanted to install an active fixture so that the tire could be rotated while the aircraft was moving. Sandaire estimated that the addition of the rotary actuator would add \$250,000 to the project; JSC did not want to spend the extra money. Smith countered that the operational costs would be reduced dramatically by the ability to reset tire rotation while the aircraft was moving. After considerable debate, JSC approved the rotary actuator, cost and all - a decision that had major consequences later in the program.⁴⁷¹

The Problems Begin

A Systems Preliminary Design Review took place in Lancaster, CA, in August 1990, during which Smith and Nagy presented the details of the computer control system. Fullerton began asking detailed questions about the function of this and that aspect of the program.⁴⁷² Smith bristled at such questions from whom he perceived to be merely the pilot and implied that it wasn't necessary for Fullerton to know the details. He seemed unaware that Fullerton was not just the CV-990's chief pilot: he had been instrumental in the orbiter's cockpit layout during the design phase and was extremely knowledgeable about system design. A conflict soon arose between the chief test pilot and the system designers that led to a reorganization of the CV-990 team: Nagy emerged as the nominal chief engineer.

During 1991 LSRA team members were summoned to a meeting with Leonard Nicholson and Brewster Shaw, Deputy Director of the Shuttle Program, and Deputy Director of Shuttle Operations, respectively, to report on the status of the project. Progress had been slow. This wasn't surprising to those familiar with the kind of unconventional research the Center was performing in this case, and it probably shouldn't have been surprising to anyone familiar with the shuttle program as a whole - delays virtually were the norm. Nevertheless, managers brought pressure to bear. It wasn't merely schedule pressure that concerned the LSRA team: the project was in danger of being cancelled. The team discovered this last bit through back channels rather than warnings from the program's leadership, but it was enough to initiate preemptive action. On hearing the scuttlebutt about cancelling the program, Facility director Ken Szalai (the Center had yet to regain its independence from Ames) personally attended the meeting at JSC to emphasize the Center's commitment to the program. The trip helped the LSRA program get the support needed to finish the modification. At this same meeting, Nicholson was shown the objectives of the LSRA test program, which included yawing the tire during rollout. He turned to Shaw and asked if those were his objectives. Shaw, who'd served as shuttle commander and pilot, said no, and made it clear that tire wear was the overarching concern and issue to resolve, something that had been glossed over in the motivating objectives of the program. Shaw wanted the capability to run full orbiter rollouts under varying crosswinds, which required the ability to steer the nose wheel in real time. Had the Center engineers not won the battle for the rotary actuator, it is very likely that the project would have been cancelled at that meeting. As it was, the LSRA had the flexibility to perform the tests because of some smart anticipation.⁴⁷³

The Airplane

At the Flight Research Center, mechanics, technicians, and engineers were deep into modifying the airplane. The most obvious and risky job was cutting a hole in the CV-990's lower fuselage, where the trapeze would

immediate response typical of a fighter. When there is no instant response, the typical reaction is to put in more of the initial command. By then, however, the aircraft is responding to the initial control input; realizing there is a second, even more dramatic response on its way, the pilot then commands a roll in the opposite direction, hopefully sufficient to counter the first and second roll commands. Because of the unaccustomed delay in response times, a pilot new to the type can very quickly start a process of countering previous control inputs with larger and larger inputs, exacerbating the situation: a pilot-induced roll oscillation develops with ever increasing amplitude. Fullerton stepped in to stop the oscillation, and Ishmael went on to control and land the aircraft without problems on subsequent flights. Nagy, notes to Christian Gelzer, October 10, 2011.

⁴⁷¹ "Statement of Work: Modification of a NASA CV-990 to a Landing Systems Research Aircraft," (NASA, n.d.), 2.1.13.

⁴⁷² Fullerton played a central role in designing the instrument and controls layout of the shuttle orbiter cockpit as part of his work in the orbiter design phase and was no stranger to systems intricacies.

⁴⁷³ Nagy, notes to Christian Gelzer, October 10, 2011.

be located and from where the tire would be lowered to the runway. To hold the tire and the mechanism that lowered it, as well as the rotary actuator, a truss had to be assembled inside the airframe. “That airplane had a center keel keeping the whole airplane together,” recalled Baron in an understated way: “Very simply, we cut the keel.”

I remember Boleslaw Szuwalski, Bill, actually jacked the airplane up and kept it all structurally sound to cut that keel, which went ‘boom’--snapped, but all the other structure stayed in place. Then we had to rebuild the structure because we’d cut the main structural component of that airplane in half. We put the Brooklyn Bridge on board the airplane, and that is no kidding. We beefed up the structure like crazy on the outside so we could put it back together after we cut it to make sure we didn’t break the airplane. Right in the middle of the two main gears there was another gear sitting there. That was the orbiter tire. With these tremendous hydraulic rams we could drive that center wheel down onto the runway surface. If things went really awry, that shuttle gear could come down and you could lift the rest of the airplane up, and you’d be a unicycle.⁴⁷⁴



The “Brooklyn Bridge,” as program manager Bob Baron called it, was anchored inside the CV-990, and held the hydraulics and the landing gear parallelogram for the orbiter tire tests. In order to fit this into the former airliner engineers had to cut the airplane’s keel. NASA EC91-0026-04

Additional modifications included adding metal plates to the underside of the fuselage as protection should a tire or wheel come apart during a test (no one had forgotten what happened to NASA’s last NASA CV-990). Aboard were two methods of fighting a tire fire: a water deluge system and a halon fire suppression system. Inside the fuselage were 48 nitrogen bottles to pressurize the 16 hydraulic accumulators during a tire test. The “Brooklyn Bridge” superstructure about which Baron joked held “parallelogram swing links which restrained the test gear” axially and vertically.⁴⁷⁵ There were two powerful hydraulic actuators to drive the parallelogram holding the shuttle tire down onto the runway. The actuators were capable of 400,000 pounds (1,779.3 kN) of force that, uncontrolled, could completely lift the 202,000-pound (91,626 kg) aircraft off the ground even with the additional 60,000 pounds (27,216 kg) aeroloads the aircraft generated.⁴⁷⁶

⁴⁷⁴ Bob Baron oral history interview, December 27, 2001, NASA AFRC Historical Reference Collection.

⁴⁷⁵ Carter and Nagy, *The NASA Landing Gear Test Airplane*, p. 3.

⁴⁷⁶ “CV-990 Shuttle Testbed Aircraft”, NASA AD88-580 [n.a., n.d.].

The First Test Flights

The airplane took to the air again December 22, 1992 carrying its new structure.⁴⁷⁷ After a series of validation flights the test program got under way, beginning formally on April 4, 1993 with a shuttle tire test on Rogers Dry Lake, Edwards AFB. The program's flights were spotty at first, typical of a flight research program (April 9, and then June 8), but the pace accelerated quickly. Before long Fullerton and Terry Rager, the chief project pilot and co-pilot respectively, were making at least one flight a day -- sometimes two.⁴⁷⁸

Baron, Nagy, John Carter (control system engineer) and company had, from the start, laid out a specific test program based on the project objectives. Lakebed landings were to test and validate the coefficients for side

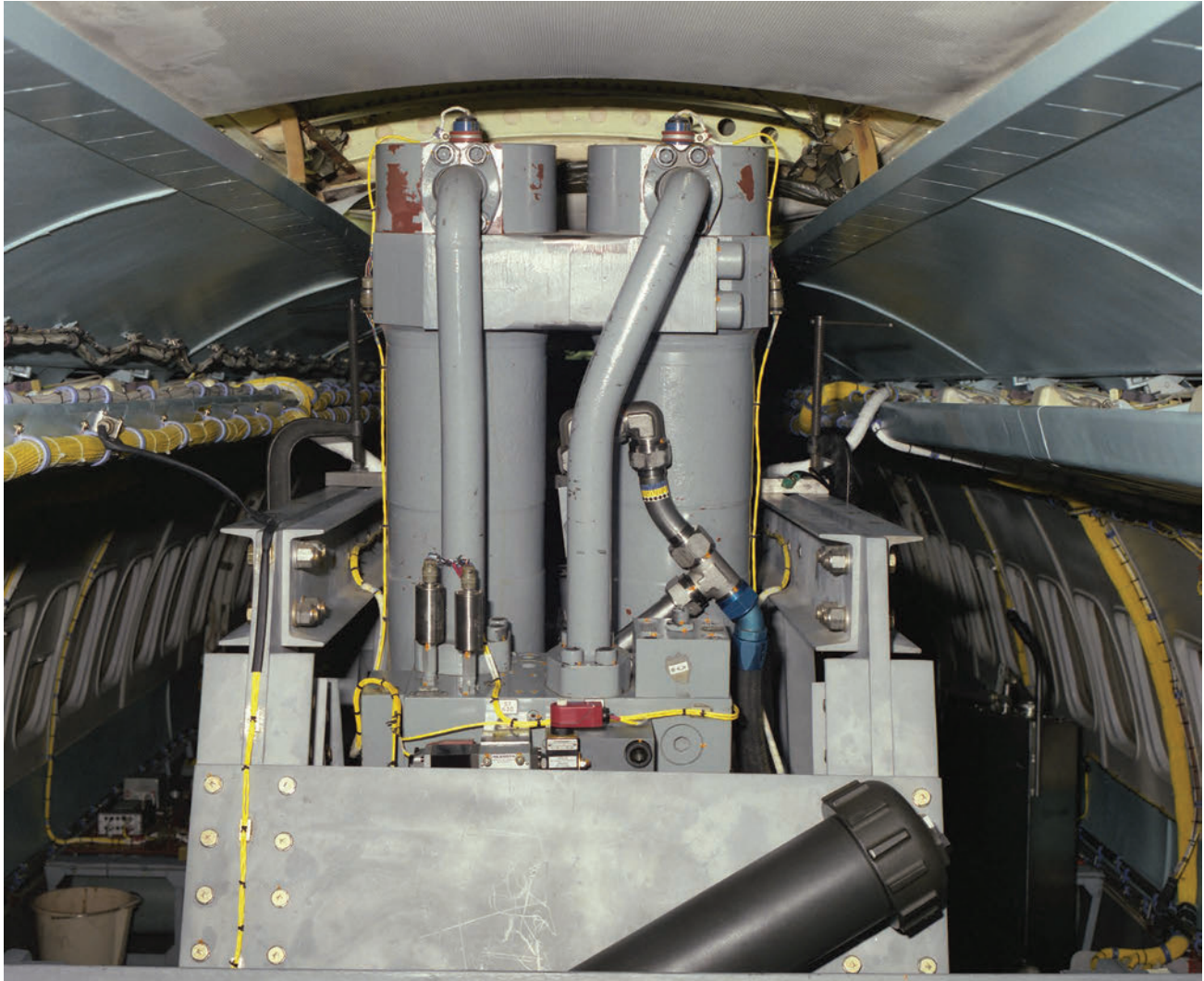

Part of the hydraulic system driving down the orbiter tire on the CV-990 in the LSRA; this view is inside the main cabin of the former airliner. NASA EC93-2093-05

⁴⁷⁷ "Beautiful flight (in spite of some problems)!! Great job by All. [sic] From mechanics on up." Daily Log, November 22, 1992, L1-9-8B, NASA AFRC Historical Reference Collection.

⁴⁷⁸ Looking at the Daily Log for this period can be breathtaking; it says much about the LSRA's importance as well. At the same time as the shuttle tire tests were under way the Center conducted, hosted, or participated in the flight programs of two F-16XLs, two X-31s, the F-18 HARV, the F-15 ACTIVE, the Pegasus booster, the Propulsion Controlled Aircraft flight program, the ERAST program, and four SR-71s, all the while operating a small fleet of F-104s, a LearJet, and a YO-3 as research and support aircraft. On the morning of July 14, 1993 there wasn't a pilot to be found on the ground at the Center: the marginalia in the Daily Log read: "Everybody flying at the same time!" On August 8 that year Fullerton and McMurtry flew the LSRA twice for research missions, after which both climbed into the cockpit of N905NA, one of the Boeing 747 Shuttle Carrier Aircraft and flew it. More often one or both pilots of the CV-990 would finish a flight and climb into another of the Center's single seat aircraft to perform another duty. In the midst of this (when both F-16XLs were flying, for example) there were times in which the logs show the LSRA in the air twice a day for days on end. Meanwhile, Terry Rager flew aircraft for NASA Ames, including the C-141, C-130 and T-38. Daily Log, 1989 and 1992. File Folders L1-9-7 and L1-9-8B. NASA AFRC Historical Reference Collection.

force and drag on an original shuttle tire. This was followed by tire wear tests on the Edwards main concrete runway. It was at this point that the tests became progressively more abusive, for the heavy side and drag loads had an especially bad effect on the tires as they rolled or skidded down the main runway. Of course, this was both expected and desired. One of the primary constraints was that every time the team conducted one of these tire wear test it left pieces of rubber all over the runway. That meant the Air Force had to close the runway while the ramp sweepers cleared it of debris to prevent foreign object damage (FOD). The LSRA was, therefore, usually restricted to flying at 6:10 a.m. (the tower opened at 6:00 a.m.) so that the runway could be cleaned by the time most operations at the base started at 7:30 a.m. On many days the LSRA crew was conducting their post-flight debriefing as Center employees were arriving at work. The only time the project could fly onto the Edwards runway during normal business hours was when only tire force tests were planned, so confident was the team in the nature of their tests.

And then, on July 16, 1993, the test tire blew out unexpectedly during a tire force test at 142,500 pounds (64,647 kg), a load below that of even the lightest shuttle flown. Overall, the event was insignificant enough that the CV-990 co-pilot took up an F-18 support aircraft later that day, but Base Operations was not happy. The team made another seven flights before the next incident, on August 9. This time it was a CV-990 main gear tire that failed. After the crew heard the explosion they ended the test and brought the aircraft to stop, although the vibration was so strong that it cracked an on-board video monitor at the test control station. Baron recalled:

We were sending our -990 tires to the Air Force to be inspected and replaced or repaired: somewhere along the line at their tire shop somebody left a couple bolts inside of a tire. Well, [they] had been bouncing enough that a bolt actually blew a hole. We stopped the airplane, [and] this one tire went poof. Then the tire next to it went: you could see the tire next say, "Oh, crap. I'm going to carry too much load." The other seven tires, which were pretty warm, gave out. Within about five or ten minutes you heard pop, pop--and we were still on the runway! All eight tires on the -990 poofed. We tied up that runway for four or five hours.⁴⁷⁹

"Blown tire, A.F. colonel came visiting this time," read the annotation in the Daily Log for the Center's flight office.⁴⁸⁰

Kennedy Space Center, Round 1

The second phase of the program involved taking the LSRA to KSC and conducting mock shuttle landings on the SLF.⁴⁸¹ The first trip to Florida came in early September 1993. It took several legs and more than a day to make the cross-country trip because the CV-990 had been so heavily modified (including disabling the centerline fuel tank for safety reasons) that its fuselage was no longer pressurized, meaning it no longer flew at altitudes of optimum efficiency. Once at KSC, the testing began on September 14 and continued daily until early October. The first test (Flight 40) on the SLF was a profile representing a heavyweight, high speed, 20-knot crosswind orbiter landing. The combination was demanding for the tires but was supposed to be within their certified capability. Bob Daugherty, the ALDF engineer who had developed the orbiter tire wear model (and who had been a long-time supporter of the LSRA effort), predicted that the tire would wear into the first cord or two, but no more.

The landing roll started at 225 knots and the LSRA decelerated to match orbiter rollout speeds. It wasn't even halfway through the rollout when the test tire blew out.⁴⁸²

If Daugherty was astonished, Shuttle Operations was worried: this test was supposed to confirm the

⁴⁷⁹ Baron, oral history.

⁴⁸⁰ Daily Log, August 9, 1993. Baron's recollection is more colorful: "We had to call up the colonel and he said, 'Get your airplane off the runway. We've got some B-1s coming back!' But we can't--we're stuck. We had to go to Dryden, get spares, and come all the way back and change tires. We tied up that runway for four or five hours and Monday morning the general came in and heard this. I think he went right to Gordon Fullerton with a colonel and said, 'Don't you guys ever do that again.' We got our butts kicked on that test. It turned out that we were doing some pretty rough tests, and we probably ended where maybe a B-1 couldn't come in. All the fighter jets could still come in behind us and use the rest of the runway; it wasn't totally out of commission all day long." Baron, oral history.

⁴⁸¹ Many at Dryden were envious of the LSRA team as it headed to Cocoa Beach for roughly six weeks. In reality, the team usually worked 10-11 hours per day, six days per week, with little time for recreation.

⁴⁸² Gordon Fullerton Oral History Interview, December 2007, NASA AFRC Historical Reference Collection.

orbiter's tire wear model and its 20-knot crosswind certification—with a modified tire, no less. There was a shuttle launch scheduled for the following week and Shuttle Operations demanded that the project stop testing immediately. But as the project did not report directly to Shuttle Operations, the testing continued—albeit with less critical test profiles. Among these were: parametric tire wear tests, the replication of the tire wear found on STS-51D, the execution of 15-knot crosswind profiles, the evaluation of the effects on the tire of pilot steering during orbiter landings, and finally, a confirmation of the 20-knot crosswind results (that last item could not have pleased Shuttle Operations). The overall results were not promising, either for the modified SLF surface or for the anticipated higher crosswind landing margins.



This tire, tested to destruction at Dryden, looks similar to ones subjected to the CV-990 first landings one KSC's runway during Round 1 of testing. EC95-43229-01

In hindsight, this is not surprising. “The SLF runway was designed with extremely rough texture and transverse grooving to provide exceptional friction performance during heavy rainfall conditions.” From the earliest landings at the Cape it became apparent that “almost every landing at the SLF had some tire-wear anomaly that could be traced to the roughness of the runway surface.” Indeed, the runway surface and its wear and tear on shuttle tires, particularly in the face of a crosswind, made tire wear “a limiting factor in flight

operations.”⁴⁸³ In retrospect, said Allen Louvaire, a NASA shuttle engineer, the runway was “a lot rougher than you think—that’s no good for a big tire” like those on the shuttles. “What were we thinking?” he asked rhetorically.⁴⁸⁴

Part of the contribution of the LSRA lay in the amount of data generated with each landing, data recorded on board during every flight that included “time histories of side force, yaw angle, and speed ... to provide a history of the side energy for the test tire.” In addition, the Center engineers had installed a video system in the tire bay so that there was correlating imagery of any abnormal activity to match the numeric data.⁴⁸⁵

After the LSRA team had completed the SLF testing they were summoned to JSC to explain the results. Present were more than just the LSRA team - and the briefing was long (4.5 hours) and highly contentious. Rockwell engineers presented their data that led to the initial 20 knot crosswind certification, and the LSRA team followed with data developed during the SLF testing which indicated only a 15-knot crosswind capability at best. Also part of the review process were ALDF track data supporting the less optimistic tire wear model. Some of the shuttle management present at the meeting were reluctant to believe the LSRA results and attempted to discredit the LSRA measurement system: in contrast, orbiter landing gear engineers from ALDF, Rockwell, and JSC generally accepted the LSRA results as accurate. Toward the end of the meeting an Orbiter Operations manager stood up, pounded his fist on the table, and exclaimed: “Do you know what it will mean to the shuttle schedule if these results get out?” It was the LSRA project’s introduction to the full-blown pressure of the shuttle schedule. The results of the briefing were that: 1) the LSRA would return to the Center and validate the measurement system via testing; and 2) the orbiter’s crosswind limits were temporarily reduced to 13 knots.⁴⁸⁶

Landing Systems Research Aircraft Validation

Back at the Flight Research Center by January 19, 1994, the LSRA team conducted a series of tests before returning to Florida for more tests. “We re-calibrated all of our instrumentation--went to the loads labs, all this kind of stuff--and we said: ‘everything on our airplane is fine. Let’s go back and do some more testing with this Michelin tire,’” said Baron. Before returning to Florida the aircraft made a few flights at Edwards to verify all systems were operational.⁴⁸⁷

Meanwhile, the ALDF crew had been busy. Based on the SLF results, it became apparent that the ALDF tire wear model was optimistic. Analysis demonstrated that the inability to run full touchdown-to-wheels-stop runs on the 1,800-foot (548.6 m) track was the culprit. Although the ALDF crew had attempted to generate full rollout results by piecing together multiple ALDF runs, they had not been able to account for the heat buildup in the tire during a continuous rollout. Each time they stopped the run at the end of 1,800 feet and repositioned it for the next run, the tire cooled down: this cooling led to the more optimistic predictions of tire wear.

It was also apparent that something needed to be done to improve tire wear on the SLF runway. Langley engineers developed a parametric test program to evaluate multiple smoothing techniques and tested them with their ITTV. Based on these results, three 10-foot (3.05 m) wide strips on the SLF runway were smoothed using the three tire-wearing candidates that caused the least damage. The runway was now ready for the LSRA to conduct full rollout tests.

Kennedy Space Center, Round 2

Once back at KSC, the LSRA team conducted 29 flights in 31 days, including three on one Friday alone, before flying back to the Center having accomplished all test objectives.⁴⁸⁸ These tests were used to evaluate the three test strips on the SLF runway to choose the best candidate for full implementation. A primary

⁴⁸³ Robert H. Daugherty and Thomas J. Yager, *Texture Modification of the Shuttle Landing Facility Runway at the Kennedy Space Center*, NASA TP 3626, (Langley, VA: Langley Research Center, 1997), p. 2.

⁴⁸⁴ Hoffman, *16.885J Aircraft Systems Engineering*, Fall 2005; visiting guest lecturer, Allen J. Louviere.

⁴⁸⁵ According to Daugherty and Yager, the two most important parameters governing tire wear that the CV-990 was able to produce (and which no other vehicle could) were weight and yaw angle. Daugherty and Yager, *Texture Modification of the Shuttle Landing Facility Runway*, p. 8.

⁴⁸⁶ Nagy, notes to Christian Gelzer, October 10, 2011.

⁴⁸⁷ By this time Michelin had replaced BFGoodrich as the shuttle tire supplier. In 1989 Michelin bought the BFGoodrich aircraft tire division and assumed the manufacture of shuttle tires.

⁴⁸⁸ One of the four CJ805 engines burned more oil than was acceptable and the crew turned back after takeoff; the plane needed an engine change before it could return to Armstrong.

objective was to demonstrate tire capability under a high speed, heavyweight, 20-knot crosswind landing. The smoothed surface also had to provide adequate traction under wet conditions, so the LSRA also conducted wet runway tire side force tests. It is likely that all three smoothing candidates could have met the basic requirements, but it soon became clear that smoothing provided by a machine called the SkidAbrader resulted in the least tire wear. Several other tests were made to evaluate the effects of pilot steering during rollouts.

It was during this segment of testing that the skill of the CV-990 flight crew shone. To accomplish the test correctly, the pilots had to put the shuttle tire down on a 10-foot wide test strip at 230 knots, control the speed of the aircraft to match the orbiter deceleration profile, and keep the tire on the test strip while crosswinds and the steering of the test tire had the strong tendency to move the aircraft laterally. Not one single test run was invalidated because the pilots failed at these tasks.



Quite a few shuttle tires failed during the tests. Although this tire did not explode, the damage incurred is indicative of how drastic even a lesser failure could be. EC95-43211-04

Back at Edwards

On their return to the Center, and not satisfied with their data, the program's engineers completed 33 more tests to answer questions posed by orbiter landing gear engineers. Several of these tests were quite spectacular, including intentionally blowing a tire and rolling on the rim to verify that it would not result in

total disaster (it produced a memorable fireball, however), and landing with a flat test tire on the lakebed and continuing the rollout to see if the rim would dig into the lakebed. “It was almost like someone had just taken a little bit of sandpaper to the rim. It was almost like you could use that rim again. You never would, but the data was that you didn’t have to worry. You could land an orbiter on the lakebed here or at the White Sands Missile Range in New Mexico, and you were not going to break it up and dig into the ground.”⁴⁸⁹ Additional tests also investigated the test tire’s top speed capability and its susceptibility to standing waves (a type of tire resonance).

During this final series of tests, the project was asked to measure drag and side forces on the orbiter nose tire. Johnson Space Center gave the project a test matrix including vertical load forces of 10,000 pounds (4,536 kg), 30,000 pounds (13,607.7 kg), and 50,000 pounds (22,679.6 kg). Since tire force testing wouldn’t result in pieces of tire flying off, the test was conducted during the middle of the day using the Edwards AFB main runway. As if on cue, as the load ramped up to 50,000 pounds the tire blew out, scattering pieces of rubber all over the runway and forcing another runway closure (tires at that pressure had the energy of about 2 sticks of dynamite). By the time the CV-990 taxied back to the Center, the colonel from Base Operations Office was waiting at the bottom of the airstair for Fullerton and he was anything but happy. The project had not anticipated a blowout and immediately called JSC to tell them what had happened. When a JSC engineer heard of the load at blowout, he said: “Oh, I don’t think the nose tire will take that kind of load.”⁴⁹⁰

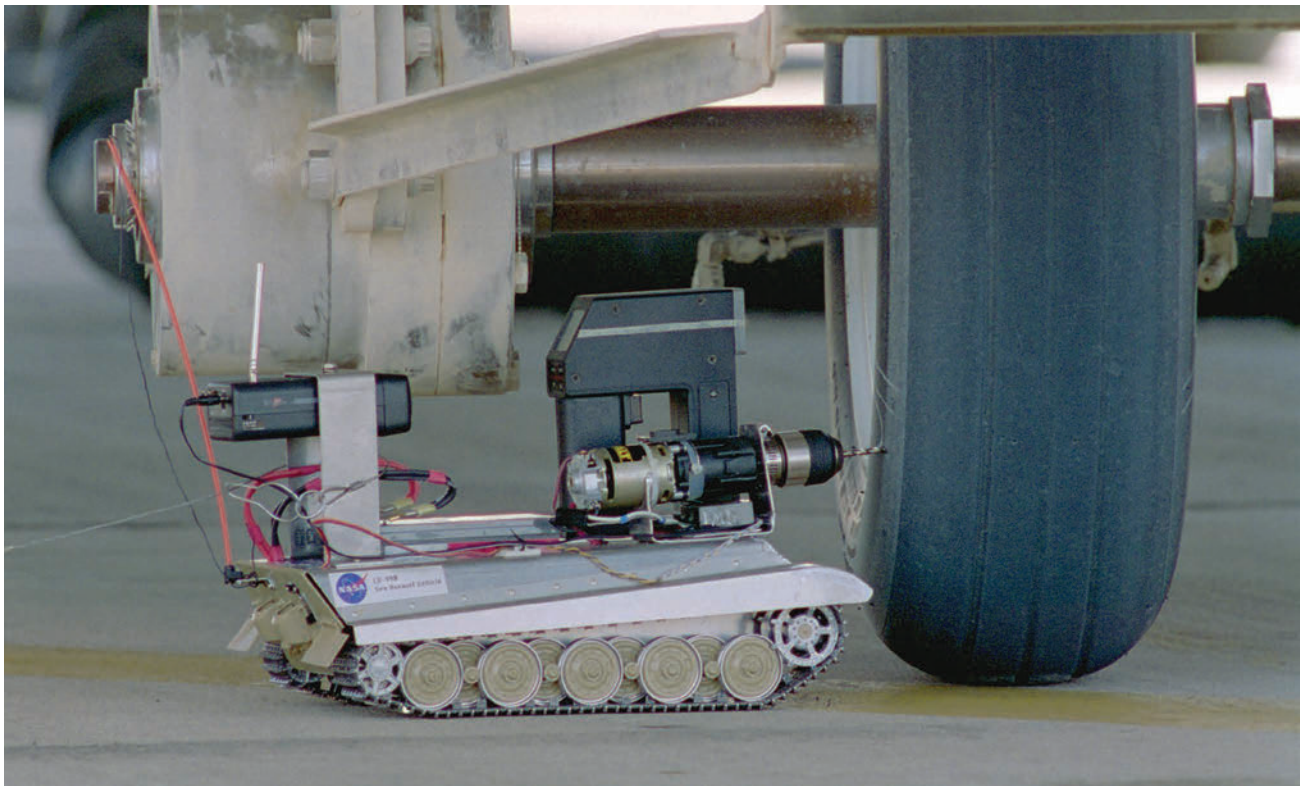

It was too dangerous to approach the tire if it had not disintegrated or otherwise deflated; it was necessary to let the tire cool down enough so that the pressure fell to safer levels. To eliminate these delays, Dave Carrott devised a homemade, inexpensive solution: a radio-controlled tank model with an off-the-shelf commercial drill mounted on top that could be driven up to the tire and then drill a hole in it, deflating the tire and rendering approach safe. EC95-43199-7

During most of these tests, the orbiter tires took a beating and most tire wear tests resulted in a severely damaged tire. Mindful of the threat posed by an overheated tire initially pressurized at 340 psi (1.54 kN/6.45 cm sq) or more and whose surface had been shredded, the project employed a bomb-disposal robot while at the SLF to drill a hole in the tire to relieve the pressure. Back at the Flight Research Center, the robot was not available on a routine basis. Dave Carrott, an engineer at the Center, developed a low-cost solution: the Tire

⁴⁸⁹ Baron, oral history.

⁴⁹⁰ Nagy, notes to the Christian Gelzer, October 10, 2011.

Assault Vehicle (TAV). This was a remotely controlled model tank purchased at a hobby shop whose turret was replaced with a cordless drill, and the TAV also sported a wireless video camera so the operator could stand well clear of the tire yet see what he was doing: drive up to the tire and drill a hole in the sidewall to let off pressure.⁴⁹¹

Conclusion

One of the more disturbing revelations to come from the LSRA work was the overestimation of the orbiter's crosswind landing capability. Bob Baron again:

The shuttle folks said the orbiter had a 15-knot [20 kts, actually] crosswind capability. As it turned out, the first time we took the 990 down to Florida and landed on that runway and went through a shuttle scenario we set the tire to replicate a 15 [knot] crosswind. About halfway through the test the tire blew.⁴⁹²

His point was clear: the orbiter did not enjoy the 20-knot crosswind capability for which it was certified. However, the LSRA was able to validate that the smoothing techniques applied to the SLF runway allowed the modified tires to have that 20-knot crosswind capability with some margin, while retaining adequate wet runway traction. Testing on the Edwards lakebed also put to rest the fear that a blowout or flat tire on that surface would lead to the wheel disintegrating and digging in. Improved tire force and wear models were developed for the SLF concrete, Edwards concrete, and lakebed landing surfaces. The LSRA also provided data to help understand the effects of pilot steering, high-speed tire performance and standing waves.

In one of the greater bits of irony, the final LSRA results revealed that the smoothed (although still rough) SLF runway provided slightly better tire wear than the very smooth Edwards runway. Engineers concluded that this was because ablative rubber from the rougher SLF runway removed heat from the tire, lessening the stored heat at the end of a rollout. The degree of tire wear was the result of a balance between scrubbing layers of rubber and allowing heat to buildup in the tire.

In the end, wrote John Carter and Chris Nagy, central investigators on the project, "the LSRA has had a significant impact on the Space Shuttle Orbiter program. Tire force and wear data from the LSRA were instrumental in upgrading tire force and wear models used by the space shuttle orbiter program. LSRA data helped to define the resurfacing requirements for the smoothing of the KSC runway surface."⁴⁹³

⁴⁹¹ The TAV is still at Armstrong and has often been on display at the visitor center.

⁴⁹² Baron, oral history. Even if crosswinds at the time of the launch were negligible, the requirement was that the shuttle would be able to return to Kennedy with a crosswind of up to 20 knots should such weather develop during ascent. STS-51D made clear that the safety margin presumed to exist for such crosswinds did not, in fact, exist at all. This discovery put a kink in NASA's launch plans, although it did not halt the launches themselves. To be fair, this discovery was only one of many NASA made as shuttle flights increased, the result of experience gained from flight itself. Other examples of this include almost endemic hydrogen leaks at the External Tank's 17 inch disconnect point, and the replenishment point for hydrogen in the external tank as the orbiter sat waiting for launch. Plans to use a yet-to-be designed 14-inch connection ultimately went nowhere. Jenkins, *Space Shuttle, The History of the National Space Transportation System* pp. 298-299.

⁴⁹³ Carter and Nagy, *The NASA Landing Gear Test Airplane*, p. 7.

15: Lifting Insulating Foam Trajectory Project (LIFT)

Gray Creech
Jacobs Technology
Edwards Air Force Base

Abstract:

The loss of space shuttle orbiter Columbia on re-entry was attributed to damage done by insulating foam shed by the external tank (ET) during shuttle ascent. Three NASA Centers undertook different tests to determine the resilience of the orbiter's reinforced carbon carbon components and the characteristics of foam pieces routinely shed by the ET in flight. Researchers at AFRC developed and flew a series of ET foam simulants on an F-15 at speeds near those attained during shuttle ascent and at similar angles of attack. Foam divots were ejected into the airflow to characterize their behavior. The researchers concluded that foam divots did not decelerate but almost always trimmed in flight, carrying with them a great deal of energy.

Keywords:

External tank (ET); Reinforced carbon-carbon (RCC); "Popcorning"; Aircraft Flight Test Fixture (AFTF); Lifting Insulating Foam Trajectory (LIFT); "Tumbling" versus "trimming"

In the aftermath of the breakup of Columbia, STS-107, during its re-entry on February 1 2003, President George W. Bush convened the Columbia Accident Investigation Board (CAIB). In its findings issued later that year the CAIB pointed to a breach in the shuttle's Thermal Protection System (TPS) near the leading edge of the left wing, as the physical cause of the accident. During ascent, a piece of insulating foam separated from the left bipod ramp area of the external tank (ET); the detached foam struck the shuttle's left wing leading edge in the vicinity of the lower half of reinforced carbon carbon (RCC) panel number 8 Left.⁴⁹⁴ Coming about 81 seconds after launch, the foam strike broke a hole in the panel estimated at 10 inches (25.4 cm) in diameter. "The widely accepted implausibility of foam causing significant damage to the wing leading edge system led the Board to conduct independent tests to characterize the impact. The image analysis established impact velocities from 625 to 840 feet per second [190.5 to 256 m/s] relative to the Orbiter, and foam dimensions from 21 to 27 inches [53.3 cm to 68.5 cm] long by 12 to 18 inches [30.5 to 45.7 cm] wide." G. Scott Hubbard, NASA Ames Center Director and member of the CAIB, suggested the potential energy in the piece of foam was akin to "catching a basketball thrown at 500 miles per hour [804.67 km/hr]."⁴⁹⁵ While the orbiter accelerated toward space the foam decelerated after leaving the ET. It made little difference that the

⁴⁹⁴ Initial analysis indicated that three pieces of foam separated from the ET during ascent; the largest one struck the underside of the left wing near the RCC panels. Photographic evidence examined the day after launch showed it to be a "piece of foam approximately 21 to 27 inches long and 12 to 18 inches wide, tumbling at a minimum of 18 times per second, and moving at a relative velocity to the Shuttle Stack of 625 to 840 feet per second (416 to 573 miles per hour) at the time of impact." *Columbia Accident Investigation Board Report, Volume 1*, August 2003, p. 34.

Concern that separating foam might damage the orbiter had been allayed somewhat in 1985 by a study done, ironically, at Armstrong in which shuttle TPS tiles were allowed to separate from an F-15 and strike the aircraft's vertical stabilizer while in flight, after which engineers analyzed the impacts. The report found that "the tile breaks immediately after impact ... the impact force exerted on the leading edge of the vertical stabilizer is relatively low. After impact, the broken tile pieces continue to travel at a velocity very close to the original before impact." In contrast to shuttle tiles, foam was less dense and more compressible, suggesting even less likelihood of damage. William L. Ko, *Impacts of Space Shuttle Thermal Protection System Tile on an F-15 Aircraft Vertical Tail*, NASA TM 85904 (Edwards, CA: Dryden Flight Research Facility, 1985), p. 15.

⁴⁹⁵ *Columbia Accident Investigation Board Report, Volume 1*, August 2003. "Just prior to separating from the External Tank, the foam was traveling with the Shuttle stack at about 1,568 mph (2,300 feet per second). Visual evidence shows that the foam debris impacted the wing approximately 0.161 seconds after separating from the External Tank. In that time, the velocity of the foam debris slowed from 1,568 mph to about 1,022 mph (1,500 feet per second). Therefore, the orbiter hit the foam with a relative velocity of about 545 mph (800 feet per second). The foam debris slowed down and the orbiter did not, so the orbiter ran into the foam. The foam slowed down rapidly because such low-density objects have low ballistic coefficients, which means their speed rapidly decreases when they lose their means of propulsion." p. 59. John Schwartz, "NASA's Foam Test Offered a Vivid Lesson in Kinetics," *New York Times* June 5, 2003. Initial estimates suggested damage to the tiles covering an area 7 inches by 32 inches. James Glanz and Edward Wong, "Engineer's '97 Report Warned of Damage to Tiles by Foam," *New York Times* February 4, 2003, <http://www.nytimes.com/2003/02/04/national/04WRON.html?pagewanted=all>, accessed May 30, 2018.

The shuttles were repeatedly struck by micro meteorites—natural and human made—while on orbit. On STS-7 in 1983 Challenger returned with pitted windowpane after being hit by a small chip of paint, for example, and STS-114 Discovery returned with 14 impact points on just five windowpanes.

material was fairly soft, lightweight insulating foam because of the relative velocity at which the two collided, and even though the foam was seen to shatter on film (there was visual evidence of a large puff beneath the left wing at the time of the strike), the impact broke open the RCC panel.

As the orbiter passed deeper into the atmosphere shockwaves formed at the spaceship's nose and leading edge of the wings; these intersected at RCC panel 9 on each wing (there were 22 panels per wing, 22 being the outermost), causing peak temperatures to reach nearly 3,000 Fahrenheit (1,649 C) at the surface. ("The hottest location on re-entry is at panel 9."⁴⁹⁶) In fact, just beyond the boundary layer the air temperature was 10,000 degrees Fahrenheit (5,538 C) and only the boundary layer at the wing's leading edge kept that incredible heat from reaching the RCC itself.⁴⁹⁷ Internally, not far behind the RCC and a layer of thick insulation, the wing's aluminum structure was kept below 350 degrees Fahrenheit (177 C). Because of the hole in the RCC, the intrusion of the superheated air, believed to be around 5,000 degrees Fahrenheit (2,760 C), eventually found its way through the insulation, heating and weakening the orbiter's left wing structure. When denser atmosphere and aerodynamic forces overcame the weakened structure the wing failed, the orbiter slewed, then broke up in flight.⁴⁹⁸

As part of NASA's Return-To-Flight effort following the loss of the Columbia and its crew, John Muratore, a NASA Johnson Space Center (JSC) engineer, approached Marta Bohn Meyer, the Flight Research Center Chief Engineer, about the possibility of helping model ET foam debris in flight. Muratore was then working for the Systems Engineering and Integration (SE&I) office at JSC. Bohn-Meyer took the matter to Center management and a plan emerged for an "experiment that could help explain how these debris might behave once it departed from the external tank."⁴⁹⁹ The objective was to obtain data showing how the small pieces of insulating foam shed from the shuttle ET behaved in flight during launch and early ascent. Engineers tried to model this behavior with computational fluid dynamics (CFD) but "aerodynamic characteristics of debris are difficult to determine using traditional methods, such as static or dynamic test data. The debris trajectories are highly non-linear, involving uncontrolled three-axis rotations."⁵⁰⁰ The type of small-scale foam loss they planned to look at, called "divoting" or "popcorning" in the shuttle engineering community, had occurred throughout the space shuttle program but had been discounted as insignificant. Following the loss of Columbia, however, all foam shedding issues, large and small, stood front and center.

Shuttle program engineers believed that popcorning was caused by captured air pockets (possibly liquefied during contact with the ET's external surface) that expanded as the atmospheric pressure fell during ascent.⁵⁰¹ "Popcorning" alluded not to kernel-sized pieces of foam but the physical process of making popcorn, during which moisture in the kernel expands at such a rate that it makes the kernel jump. This change, or delta (Δ) in the "cell pressure" led to a "cohesive/adhesive strength failure."⁵⁰² The theory regarding ET foam was that the pressure change caused a sudden expansion of the air, imparting enough kinetic energy to literally pop off a piece of foam. What happened to that piece of foam was now a matter of concern: did it fly far away from the ET, did it pop off the surface and stay within the tank's boundary layer, did it enter the freestream airflow?

NASA had stringent requirements for the ET insulation. First, of course, it had to keep the propellants at their proper respective temperatures: liquid hydrogen at -423 degrees Fahrenheit (-253 C) and liquid

⁴⁹⁶ Frances I. Hurwitz, "Thermal Protection Systems (TPS)," *Encyclopedia of Aerospace Engineering*, Edited by Richard Blockley and Wei Shyy, John Wiley, 2010, pg. 4.

⁴⁹⁷ There is a well-written, technical but accessible description of the orbiter's TPS in *Wings in Orbit*. See Gail Chapline, Alvaro Rodriguez, Cooper Snapp, Myron Pessin, Paul Bauer, Bruce Steinezt, Charles Stevenson, Charles Stevenson, "Thermal Protection System," in *Wings in Orbit: Scientific and Engineering Legacies of the Space Shuttle*, ed. Helen Lane, (Washington, D.C.: NASA, 2001), p. 187. https://www.nasa.gov/centers/johnson/pdf/584728main_Wings-ch4b-pgs182-199.pdf, accessed June 10, 2018.

⁴⁹⁸ *Columbia Accident Investigation Board Report, Volume 1*, August 2003, pp. 12, 35, 38-43, 69. Entry Interface was an arbitrary point, determined to be 400,000 feet AGL. Aluminum melts at 900 degrees F. Entry Interface began some 5,000 statute miles from the landing site and an altitude of 557,000 feet, with the orbiter traveling roughly 25,000 feet per minute, and lasted until the orbiter was within 59 miles of its landing site, an altitude of 83,000 feet, and a speed of 2,500 feet per second. From EI start to landing could take 30 minutes. http://science.ksc.nasa.gov/shuttle/technology/sts-newsref/sts_mes.html#mes_entry and http://www.nasa.gov/mission_pages/shuttle/launch/landing101.html, accessed June 10, 2015.

⁴⁹⁹ Ting Tseng, interviewed by Christian Gelzer June 16, 2015, NASA Armstrong Flight Research Center.

⁵⁰⁰ Michael J. Aftosmis and Stuart E. Rogers, *Characterization of Space Shuttle Ascent Debris Aerodynamics Using CFD Methods*, AIAA 2005-1223, (43rd AIAA Aerospace Sciences Meeting, Reno NV, January 10-13, 2005), p. 2.

⁵⁰¹ *Columbia Accident Investigation Board Report, Volume 1*, 53. "Cryopumping" and Cryoingestion" defined the concepts in question, p. 53.

⁵⁰² "Lifting Insulation Foam Trajectory (LIFT) Flight Test," Objectives & Requirements Document (ORD) 04-001, v.1, February 2, 2005. NASA Dryden Flight Research Center, p. 3.

oxygen at -297 degrees Fahrenheit (-147 C). It had to do this in ambient temperatures as high as 118 degrees Fahrenheit (47.7 C) and 100% humidity while sitting on the launch pad; it had to be durable enough to survive on the launch pad almost six months (without the propellants); and after all this it still had to withstand external temperatures as high as 1,200 degrees Fahrenheit (649 C) from aerodynamic friction during ascent. It did all this with a typical foam thickness of 1 inch, although there were areas where it reached 2 inches thick. Most of the ET insulation was light weight, sprayed on, closed-cell foam. Those areas that endured high heating from aerodynamic forces or proximity to the rocket engines were generally covered with an ablative, high-temperature ceramic fiber foam, but these amounted to a fraction of the total area. The surface area of the ET was roughly 12,700 square feet—close to 1/3 of an acre (.135 hectares).⁵⁰³

The SE&I office at JSC funded three studies of foam divot flight trajectories. One study, conducted by Calspan Corp., was performed using a wind tunnel. NASA Ames performed another test, a ballistic test that followed CFD work.⁵⁰⁴ For this, Ames used its Gun Development Facility (GDF), part of the larger Hypervelocity Free-Flight Facilities, to conduct dynamic tests. In addition to a hypersonic launch tube in which tests can be done in controlled environments, the GDF has a tunnel segment with a nearly two-meter square cross section with shadowgraph capability, ideal for stop-motion photography of foam divots as they decelerated.⁵⁰⁵

The third test was assigned to the Center and named the Lifting Insulating Foam Trajectory (LIFT) project. The LIFT flight-test series involved carrying a divot ejection system in a real flight environment at speeds up to Mach 2.⁵⁰⁶ The LIFT project was initially a contingency plan in case the Calspan and Ames tests were indeterminate, but JSC concluded that tests in a dynamic environment more closely resembling the ascent profile of the space shuttle orbiter were warranted regardless of the other tests.⁵⁰⁷ “Since the F-15 was a Mach 2+ aircraft,” recalled Ting Tseng, an engineer on the project, “it was able to simulate a part of the ascent trajectory of the space shuttle, a small part of it. It allowed us to model what the shuttle flight condition might be for that short period of time. So, based on that [capability and the limitations of the other tests], we were provided funding to go and develop an experiment that allowed us to take the same foam used on the External Tank and design a system where we could eject foam.”⁵⁰⁸ Ultimately the shuttle program would use these data to validate CFD models.

The LIFT tests were to answer two primary questions: first, did the foam divots break up once they came off the ET and entered the airflow; and, second, did the divots trim or tumble in flight. In this context, “trimming” meant aligning with the airflow - assuming “a stable orientation with respect to the freestream airflow”; tumbling meant just that.⁵⁰⁹ (“Trimming” did not imply that the divot took up any specific orientation when trimmed, only that it was stable once in the airstream.) Whether a divot trimmed or tumbled made a huge difference in the amount of kinetic energy it could impart if it struck the orbiter: tumbling pieces of foam slowed down faster than trimmed foam. The key is the relative speed of the divot: if foam separated from the ET during ascent and entered the airstream near the orbiter, the best scenario for it was to retain as much of its initial energy (momentum) as possible. The less energy it maintained—the more it slowed—the greater the potential damage if it struck the orbiter. Ames’ work modeled the flight pattern and cross-range of divots, and while very important, the CFD work left “a lack of relevant experimental data for validating numerical predictions of debris dynamics.” The LIFT tests needed to closely match the Mach number and dynamic

⁵⁰³ NASA Fact Sheet FS-2004-08-97-MSFC, August 2004, pp. 1-2. See also “Street Math, Space Shuttle,” NASA Jet Propulsion Laboratory, California Institute of Technology, 2016; and “Space Shuttle External Tank Statistics and Comparisons,” Lockheed Martin Space Systems Company, Michoud Operations, February 2008.

Closed cell foam is made when gas pockets form in the medium as it solidifies. Open cell foam is spongy and soft and has no structure of its own.

⁵⁰⁴ Aftosmis and Rogers, *Characterization of Space Shuttle Ascent Debris*, p. 9. See also Lifting Insulation Foam Trajectory (LIFT) Flight Test Objectives & Requirements Document (ORD).

⁵⁰⁵ Aftosmis and Rogers, *Characterization of Space Shuttle Ascent Debris*, p. 9. See also <https://www.nasa.gov/centers/ames/orgs/exploration-tech/range-complex.html#.Vb-x7UXVbFk>, accessed August 3, 2015. For CFD work done by Ames see Scott M. Murman, Michael J. Aftosmis, and Stuart E. Rogers, *Characterization of Space Shuttle Ascent Debris Aerodynamics Using CFD Methods*, (43rd AIAA Aerospace Sciences Meeting, January 10-13, 2005).

⁵⁰⁶ Stephen Corda, Donald Whiteman, Ting Tseng, and Ricardo Machin, *The F-15B Lifting Insulating Foam Trajectory (LIFT) Flight Test*, NASA TM-2006-213674, (Edwards, CA: NASA Dryden Flight Research Center, June 2006).

⁵⁰⁷ “Lifting Insulation Foam Trajectory (LIFT) Flight Test,” p. 3.

⁵⁰⁸ Tseng, interviewed by Christian Gelzer.

⁵⁰⁹ Corda, Whiteman, Tseng, and Machin, *The F-15B Lifting Insulating Foam Trajectory (LIFT) Flight Test*, p. 4.

pressure the orbiter experienced at discrete points during its ascent profile, something Center engineers and pilots could provide with an F-15B. This was why JSC valued actual flight test results.

Flight Test System Fabrication

Atmospheric flight research is a multi-disciplinary field requiring experience in many complicated systems, including subsonic and supersonic aircraft and many types of experimental, often one-of-a-kind flight-test and research equipment. Computer hardware and software systems represent another integrated discipline and played an integral role in this after the Flight Research Center developed and flew the world's first digital fly-by-wire aircraft in the 1970s. The Center was the logical choice for the LIFT project because no other NASA Center had aircraft capable of flying at Mach 2, which capability was essential to the success of the project. Chief among them was a McDonnell F-15B which served as a flying testbed and regularly carried a Flight Test Fixture (FTF) in the ventral position. F-15B tail number 836 was the designated aircraft for this role.



The Aircraft Flight Test Fixture attached beneath Dryden's F-15B. On the right side are two pieces of External Tank foam embedded in the test fixture; they are light in color compared to the rest of the fixture. NASA EC05-0030-01

This was a second-generation FTF, designated the Aerodynamic Flight Test Fixture, that replaced the one flown on the Center's F-104 (tail number 826). A composite structure (107 in. l x 32 in. h x 8 in. w--272 x 81 x 20 cm), the AFTF is modular, having four upper and lower bays in which experiments can be placed. There are two other FTFs tailored for different purposes.

Although Center personnel had considerable experience in the field, the LIFT flight-test required the combination of two new capabilities: an in-flight foam divot ejection system, and a high-speed video system to track and record the trajectories of the divots while the aircraft flew at speeds up to Mach 2. Engineers at the Center developed both capabilities in just over two months, and ground-tested them, flight qualified the video system, and performed the actual test over three more months.⁵¹⁰ This rapidity was due to the fact that

⁵¹⁰“F-15B Lifting Insulation Foam Trajectory (LIFT) Flight Test: Phase 1—Design and Ground Test Review,” NASA Dryden Flight

JSC gave the Flight Research Center a free hand to design and develop the necessary equipment - critical because in doing so JSC turned over not only the engineering responsibilities, but also those related to F 15B flight safety.⁵¹¹

The Flight Research Center's LIFT project team designed, fabricated and tested four different divot ejection systems before selecting the best one for the flight tests. They conducted no less than seventy ground tests to determine the best testing approach; all the while making refinements leading to the ground and flight testing. The selected divot ejection system was then integrated with F-15B AFTF.⁵¹² The concept wasn't entirely new but the objectives and the constraints were. The Center project team, led by Stephen Corda, decided to design the divot ejection system right into the AFTF, avoiding the time and complexity that an "add-on" system would entail.

The first system, called the "burst disk system," used high-pressure nitrogen gas to eject a pre-formed divot from a cylindrical tube. A cylinder held the compressed gas (nitrogen) while a frangible disk blocked the gas from reaching the divot. Once the disk was broken, the compressed gas simply expelled the divot.⁵¹³ The method had the benefit of no moving parts but the tests raised concerns about flow disturbances resulting from the sudden volume of nitrogen gushing out behind the divot, even though the gas was under comparatively low pressure.

The second system, dubbed the "piston/reservoir, claw release" was, in contrast, fairly complex, although it carried with it a benefit. In this instance a tank with pressurized nitrogen would, on command, drive a piston through a cylinder: the piston face would then expel the divot. A mechanical claw held the piston back until release. The divot sat on the piston face and since gas was itself not the cause of expulsion, this second system provided better exit velocity control for the tests and avoided the "muzzle blast" of nitrogen that came with the first system. But its complexity outweighed its attributes. (The LIFT project team toyed with the idea of eliminating the claw and merely using compressed nitrogen to drive the piston, but manufacturing and flight certification put them off that plan. Among other things, this alternative required a frangible bolt to release the piston.)

The third ejection method the team explored was a "guided pneumatic system" in which the center of the divot rode down a thin, needle-like metal spike (dubbed the "kabob" system). The needle served as a guide to keep the divot on track during ejection from the tube. "The pin itself didn't really work well," recalled Tseng.⁵¹⁴ Ground tests revealed that the needle guide "hindered divot ejection" but that the cylinder without the needle worked well and ejection with this method was less destructive to the divots than was the "burst disk" method.⁵¹⁵ Without the needle, this method used a "mechanical piston system" that simply punched the pre-formed divot from a cylinder.⁵¹⁶

In the end the project built, tested, and then settled on a fourth system, known as the "pressure-failed sheet" system. By comparison to the first three it was simple in operation and produced divots more representative of those actually shed by the ET. This fourth system used flat aluminum plates, each with four to five pre-cut voids (holes); each plate was covered in Stepanfoam® BX-265, one of the foams used on the ET.⁵¹⁷ Nitrogen was plumbed to each void in the aluminum plate, and on command, released under pressure to expel the divot. The team tried uncut and perforated divots and found that the uncut divots created natural, irregularly shaped pieces "more representative of the real event."⁵¹⁸ The JSC SE&I office, not the engineers at the Center, had determined the approximate shape of the divots the LIFT project would try to produce.⁵¹⁹

The foam on the aluminum plates formed sheets about two inches thick, replicating what was sprayed on

Research Center, November 5, 2004.

⁵¹¹ "F-15B Lifting Insulation Foam Trajectory (LIFT) Flight Test: Phase 1."

⁵¹² Dryden has several FTFs of different sizes and shapes to accommodate experiments and has regularly flown customers' structures themselves from beneath the F-15B.

⁵¹³ *Columbia Accident Investigation Board Report, Volume 1*, 53-54. "F-15B Lifting Insulation Foam Trajectory (LIFT) Flight Test: Phase 1," p. 47.

⁵¹⁴ Tseng, interviewed by Christian Gelzer.

⁵¹⁵ "F-15B Lifting Insulation Foam Trajectory (LIFT) Flight Test: Phase 1—Design and Ground Test Review," p. 75.

⁵¹⁶ "F-15B Lifting Insulation Foam Trajectory (LIFT) Flight Test: Phase 1—Design and Ground Test Review."

⁵¹⁷ BX-265 was one of four closed-cell foams used on the ET, each type meant for a specific area. BX-265 was applied to "close-out" areas of the tank. NASA Fact Sheet FS-2004-08-97-MSFC, August 2004.

⁵¹⁸ "F-15B Lifting Insulation Foam Trajectory (LIFT) Flight Test: Phase 1—Design and Ground Test Review," p. 93.

⁵¹⁹ "JSC and their external tank foam manufacturer decided on a certain shape [of divot] they wanted." Tseng, interviewed by Christian Gelzer.

some areas of the shuttle ETs. Three bays in the AFTF were configured to carry the aluminum plates. For the ground tests, an inexpensive blue Dow Chemical Co. Styrofoam™ was used to verify the operation of the system before the data-recording flights, since the Styrofoam™ had a similar density to the BX-265 but was a cheaper substitute. The divots produced by both the Styrofoam™ and the BX-265 were very similar.⁵²⁰

The AFTF 200-cubic-inch nitrogen reservoir tank held the gas at a pressure of 300 psi (1.334 kN/6.45 cm sq), which a pressure regulator reduced to between 40 to 80 psi (.1779 kN/6.45 cm sq to .3358 kN/cm sq) before reaching each void, depending on the test. In an effort to encourage the formation of randomly shaped divots, when the back of the foam in each void was pressurized, the foam on the area in front of each void was scored to help create a fracture line.⁵²¹ The diameter of the precut voids ranged from about .33 inch to 1.3 inches (.84 to 3.3 cm), resulting in divot diameters from 2.5 to 5.5 inches (6.35 to 14 cm). Adhesive foil thermocouples, bonded to the edges of the foam sheets, measured the foam surface temperatures at two locations on each foam sheet. “We did some ground test to show the ejection method and we could reproduce the divot shape based on the precut method.”⁵²²

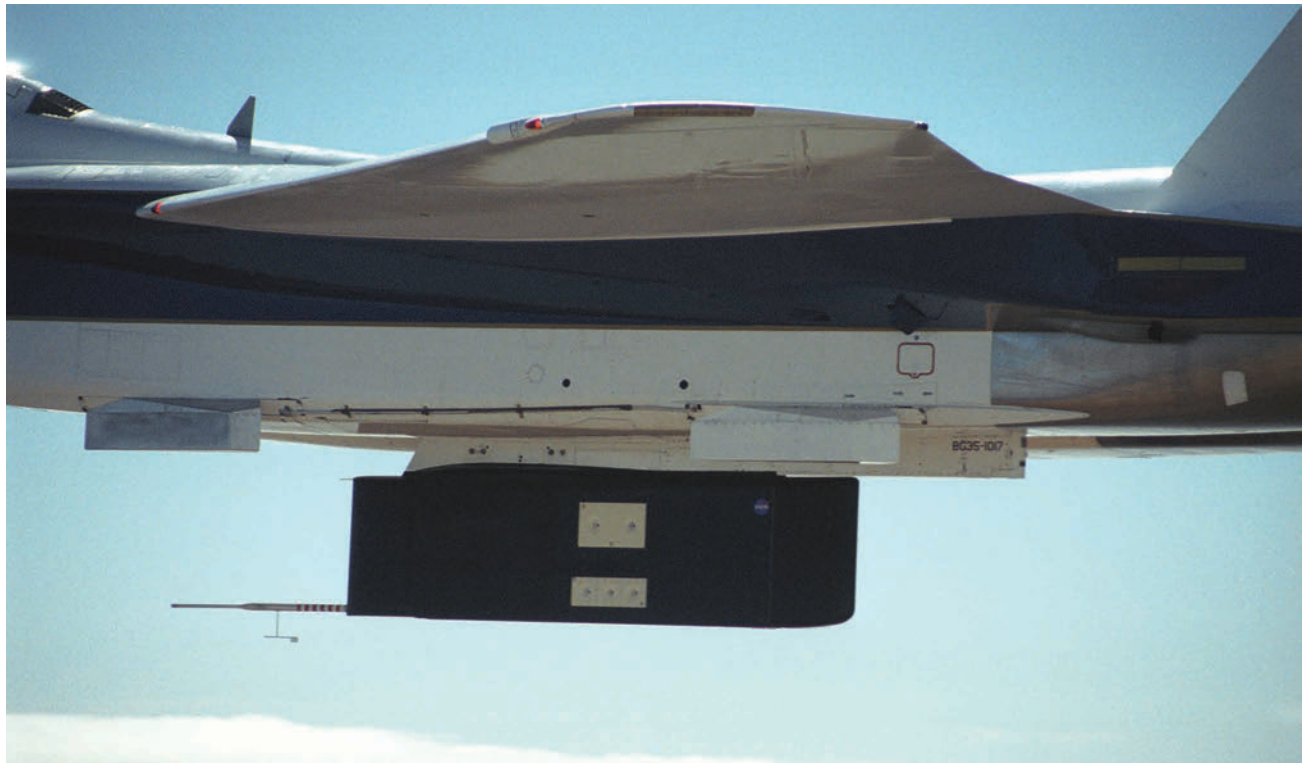

This view of the Aircraft Flight Test Fixture shows the five divots having been ejected from the foam template and the two camera pods, fore and aft of the Flight Test Fixture, attached to a missile rail. NASA EC05-0030-13

There were limitations to this system in spite of how well the engineers were able to simulate the actual popcorning of ET foam. Among them was that foam surface temperature conditions for the AFTF were not the same as those on the orbiter. During a shuttle’s ascent the foam’s inner surface (right next to the shuttle ET) was exposed to cryogenic temperatures, while the foam’s outer surface was being aerodynamically heated - peaking at 1,200 degrees Fahrenheit (649 C). But without designing and constructing a prohibitively expensive rocket-based flight experiment to accomplish the LIFT tests, no better method of obtaining actual flight data on foam divots could be developed; both the Center and JSC engineers understood and accepted these limits when the LIFT tests began.⁵²³

For decades, engineers at the Center have been accustomed to working in the risk-fraught environment of flight research and testing. Arguably some of the riskiest atmospheric research and test flights ever flown

⁵²⁰ There are different varieties of Stepanfoam®: the one selected for the ET was known as BX-265.

⁵²¹ “F-15B Lifting Insulation Foam Trajectory (LIFT) Flight Test: Phase 1—Design and Ground Test Review,” p. 9.

⁵²² Tseng, interviewed by Christian Gelzer.

⁵²³ Corda, Whiteman, Tseng, and Machin, *The F-15B Lifting Insulating Foam Trajectory (LIFT) Flight Test*, p. 2.

have been planned and conducted from the Center. Not surprisingly, the safety culture at the Center has a rich heritage tempered by loss-of-life accidents as well as aircraft accidents. When it came time to perform the hazard analysis for the LIFT project, the research and flight team used the standard high-performance aircraft and flight safety plan used on each and every flight project, with additional specifics related to this particular operation.

Two unusual safety hazards concerned LIFT project engineers: the first was the possibility of ejected divots contacting the F-15B after ejection from the FTF; the second - much less significant - was the possibility of ejected divots striking objects or people on the ground. In fact, there was little risk of injury or damage being caused by a foam divot landing on the ground because the aircraft would be flying over a controlled test range at Edwards Air Force Base (mostly devoid of people) and because the small pieces of foam would decelerate on their way to the ground. While the possibility of foam divots flying up and striking the F-15B was not unrealistic, the potential damage was ultimately considered not material for a number of reasons, not the least of which were that the likely impact area's substructure was strong honeycomb aluminum, not impact sensitive RCC or brittle ceramic and silica; and the F-15B is a combat aircraft designed to absorb and survive battle damage. Moreover, analysis of the BX-265 indicated that it would compress on contact with the aircraft, absorbing much of the kinetic energy, and if it did strike the aircraft it would not be at the oblique angle so detrimental to the orbiter. It might appear as unnecessary caution, but it is the sort of precaution that keeps the Center's pilots and aircraft coming back safely after each flight.⁵²⁴

Small, lightweight objects departing an aircraft flying at Mach 2 are not easy to see, even if you know when they are going to make the 'jump.' They are even harder to spot if they are sand colored and the aircraft is flying over a desert. The Flight Research Center's LIFT project engineers decided that the best way to record the divots at their critical moments in flight was to use a very high-speed digital video camera system. Lacking anything suitable *and* flight qualified, the team developed something specific to the project. They arrived at a color video system using two flight-qualified cameras synchronized with the divot ejection system. This system-within-a-system consisted of a digital card that triggered the high-speed cameras and the divot ejections in a timed, sequential order. A relay card, also developed by Center engineers, provided the switching interface between the digital card and the ejection system.⁵²⁵ A flight test engineer in the back seat of the F-15B triggered each divot ejection with a switch and coordinated activities with Mission Control at the Center throughout the flight.

Though the cameras were capable of recording at a rate of 10,000 images per second (a digital image reference analogous to frames per second, or FPS), a rate of only 2,000 images per second was used for all LIFT data flights in order to conserve enough data for each flight. "At the time," said Tseng, "memory technology and the high-speed recording business was just starting to take off, so they didn't really have equipment that was geared toward being able to do large amounts of recording for a long period of time, so we had to devise a system to meter the amount of time we spent taking data on a given flight."⁵²⁶ The frame rate of 2,000 resulted in an exposure time of 50 microseconds per divot ejection at a resolution of 1,280 by 512 pixels.⁵²⁷

Two camera heads were mounted separately in small wedge-shaped aluminum pods attached to the aircraft's left fuselage missile rail stations, one forward and the other aft of the AFTF. Three-dimensional CFD was used to analyze the flow around the camera pods to assess leading-edge shock wave locations, base region reattachment shock wave locations, base region wake flow impingement, and pressure distributions, since the F-15B would be flying close to Mach 2 during some of the tests.⁵²⁸

Using wide-angle lenses to take in the required field of view, the cameras captured images of each divot's

⁵²⁴ Corda, Whiteman, Tseng, and Machin, *The F-15B Lifting Insulting Foam Trajectory (LIFT) Flight Test*, p. 27.

⁵²⁵ Stephen Corda, Ting Tseng, Matthew Reeves, Kendall Mauldin, and Donald Whiteman, "Very High-Speed Digital Video Capability for In-Flight Use," *NASA Tech Briefs*, February 2006. Qualifying instruments and equipment for flight is essential to preclude interference between the experiment and aircraft systems when operating.

⁵²⁶ Tseng, interviewed by Christian Gelzer.

⁵²⁷ Corda, Tseng, Reeves, Mauldin, and Whiteman, "Very High-Speed Digital Video Capability for In-Flight Use," *NASA Tech Briefs*, February 2006, p. 9.

⁵²⁸ Corda, Whiteman, Tseng, and Machin, *The F-15B Lifting Insulting Foam Trajectory (LIFT) Flight Test*. What may be lost on some is the amount of work necessary to mount two small cameras under the wing of a tactical military fighter—on existing missile rails, no less. The Center is not alone as an entity when it comes to cautious research in cases such as this, but the extent of the tests reflects the Center's earnest approach to risk.

release and separation as far as five feet downstream of the ejection point; the cameras relied on in-flight, ambient light only. Center engineers developed videographic analysis techniques, in addition to standard photogrammetry analysis techniques, to quantify and characterize divot trajectories and behaviors post flight (such as measuring divot spatial position, rotation, and velocity). In part, said Stephen Corda, this was because the flight tests were also meant to determine divot structural survivability and stability in flight.⁵²⁹

The chief goal of the LIFT project was to generate trajectory data about ET foam divots in an actual flight environment. Did the divots break up on entering the airstream or remain whole? And did the divots trim or tumble in flight? The results of the LIFT project went to the SE&I office at JSC and were incorporated into the space shuttle's ascent CFD modeling.

The LIFT project flight test conditions included multiple test points, from subsonic to just shy of Mach 2, and an altitude of 50,000 feet (15.24 km), approaching the edges of the F-15B flight envelope while carrying the AFTF. In comparison, the STS-107 destructive foam strike occurred at Mach 2.5 and 69,000 feet (21 km). The F-15 was the fastest production aircraft available to NASA, hence the inability to match the STS-107 foam strike flight conditions without a rocket-powered vehicle.⁵³⁰ Despite the limitations, the flights matched discrete points along the shuttle ascent trajectory, which was entirely satisfactory to engineers at both the Flight Research Center and JSC. Divots were ejected with the F-15B at wings level and a constant altitude and airspeed. The LIFT project completed 10 flights at different speeds and altitudes, during which 36 divots survived ejection and deceleration for subsequent photogrammetric analysis. (Three divots contacted the foam sheet and fractured.) Perhaps most significantly, "all 31 of the supersonically ejected divots trimmed." Five ejections were made subsonically: only two of these tumbled.⁵³¹

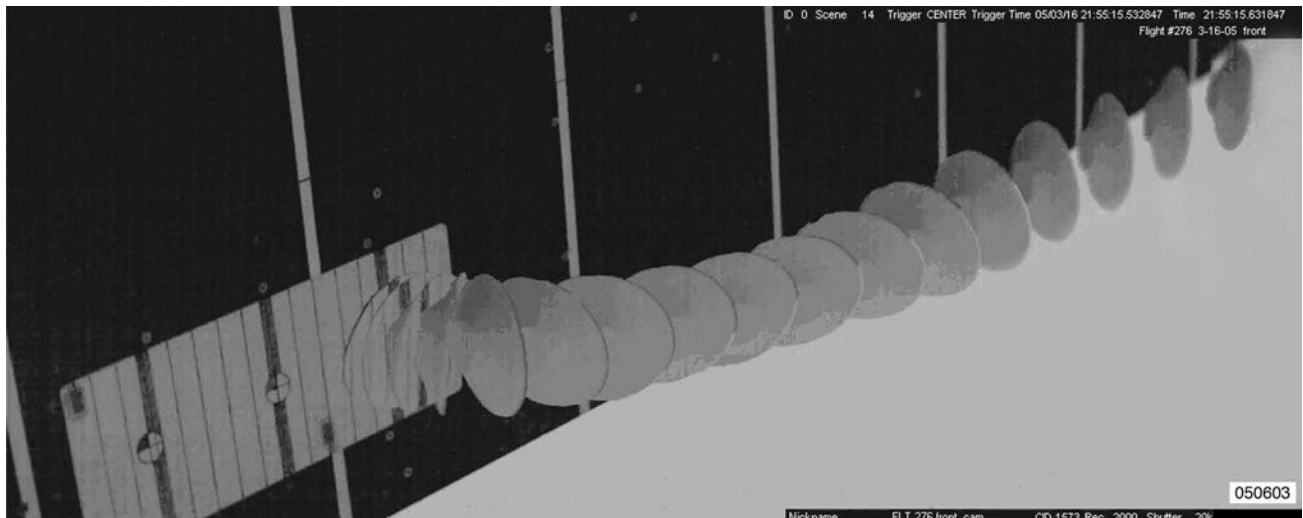

This in-flight ejection sequence from the F-15B AFTF shows the flight characteristics of the divot as well as the imaging capability that Center engineers developed. LIFT Ejection Sequence, NASA AFRC

The divot ejection flight-test conditions were divided into three categories: maximum Mach number, maximum dynamic pressure, and maximum aerodynamic torque on the divot, the latter determined by the product of the divot moment coefficient and dynamic pressure, all to better understand the variable flight path of the random popcorn foam from the ET.⁵³² All of these data were shared with the CFD engineers at JSC who were modeling the events surrounding shuttle ascent (Debris Transport Analysis).⁵³³ Six divots either failed to eject or were broken by the ejection process.⁵³⁴ Regardless of the speed at which the ejections took place, no data at all existed on foam behavior in flight prior to the LIFT project, so any data the Center generated were considered helpful. Moreover, while the impact that doomed Columbia was supersonic, the shuttle community was interested in subsonic foam loss and potential impact with the orbiter, especially if that foam contained

⁵²⁹ Corda, Whiteman, Tseng, and Machin, *The F-15B Lifting Insulting Foam Trajectory (LIFT) Flight Test*.

⁵³⁰ Corda, Whiteman, Tseng, and Machin, *The F-15B Lifting Insulting Foam Trajectory (LIFT) Flight Test*.

⁵³¹ Corda, Whiteman, Tseng, and Machin, *The F-15B Lifting Insulting Foam Trajectory (LIFT) Flight Test*, p. 49.

⁵³² Corda, Whiteman, Tseng, and Machin, *The F-15B Lifting Insulting Foam Trajectory (LIFT) Flight Test*, p. 27.

⁵³³ Corda, Whiteman, Tseng, and Machin, *The F-15B Lifting Insulting Foam Trajectory (LIFT) Flight Test*, p. 49.

⁵³⁴ Corda, Whiteman, Tseng, and Machin, *The F-15B Lifting Insulting Foam Trajectory (LIFT) Flight Test*.

ice crystals, because ice adds mass (something the tests themselves could not determine).⁵³⁵

Regarding the trimmed divots, said Tseng: “We were able to ascertain how these foam divots would behave: it turns out that once [the divots] went out in the airstream and would actually trim, at a certain position and would reduce speed rapidly so that whatever [the divots] would strike—a leading edge—[they] would actually impart significant energy.”⁵³⁶ Importantly, divots did not break up once in the airstream, and more significantly, they almost always trimmed in flight. A divot “would eject, tumble once, and trim. That was the behavior that we saw. After ejection, the conical frustum-shaped divots tended to trim with their large diameters facing upstream.”⁵³⁷ That the divots trimmed instead of tumbled was positive information to engineers.

The LIFT project team accomplished the requirements of the project in-house, including designing and constructing a divot ejection system and developing a synchronized high-speed digital video system. This flight-research-ready system, flown on a NASA F-15B, provided the Center-derived data that helped fill in and confirm gaps in limited existing foam trajectory computer models, known as Debris Transport Analysis, for the space shuttle program following the loss of the Columbia.

⁵³⁵ Corda, Whiteman, Tseng, and Machin, *The F-15B Lifting Insulting Foam Trajectory (LIFT) Flight Test*.

⁵³⁶ Tseng, interviewed by Christian Gelzer.

⁵³⁷ Corda, Whiteman, Tseng, and Machin, *The F-15B Lifting Insulting Foam Trajectory (LIFT) Flight Test*, p. 49.

Conclusion

16: Conclusion

Christian Gelzer
Logical Innovations, Inc.
NASA Armstrong Flight Research Center

Despite the space shuttle's retirement NASA's Armstrong Flight Research Center remains involved in various space related activities. Even while the shuttle still flew, the NB-52B carrier aircraft served as the launch platform for at least five Orbital Sciences Corporation Pegasus[®] rockets carrying experiments to suborbital or orbital altitudes. These included the PHYSX (Pegasus[®] Hypersonic Experiment), a wing glove carried on the winged version of the rocket. The objective of PHYSX was hypersonic boundary layer transition data in order that designers could better characterize this transition in their computational modeling.⁵³⁸ The effort was connected to an Agency-wide program for reusable space access vehicle. The PHYSX project derived from one of the enduring questions dating to the X-30 NASP (National AeroSpace Plane) program: was airflow over a wing in the hypersonic portion of the flight turbulent or not, and where on the wing did this transition take place - if indeed it did? The answer was critical for the design of any future hypersonic vehicle. So far, the very conservative (if unrealistic) assumption had been that the flow would be turbulent; as a result, engineers either designed ways to actively cool the wing or planned for a heavier structure in order to deal with the higher temperatures associated with turbulent flow. Building on the long history of the Flight Loads Laboratory with hypersonics (dating to the X-15 and continuing with the shuttle program), engineers tested wing panels and coupons - items indirectly connected to the X-30 - subjecting them to both thermal and loads testing. Among the tests was work on de-bonding analysis of curved composite panels that were heated on one side and cooled on the other.⁵³⁹ Other work in the Laboratory examined the buckling characteristics of a "hat-stiffened" titanium wing panel for hypersonic flight.⁵⁴⁰

In 1988 NASA sponsored a hot structures workshop and invited members from other Agency Centers, industry, and other government partners to Armstrong. It is a reflection of the Flight Loads Research Facility's competency in the field that the majority of the papers presented at the workshop came from Armstrong—and not because it played host: the Center had long experience flying in this realm and testing materials for this and other regimes. Wrote one of the attendees: [The] "most valuable conference on NASP so far." Added another: "This workshop has been the best congregation of 'doers' in test technology, specifically in high temperature application."⁵⁴¹

In the new millennium the Flight Loads Laboratory undertook a series of high temperature tests on a ruddervator for the X-37 reusable spacecraft. Part of the experiment lay in validating the use of carbon-carbon with carbon-silicon-carbide composites in the same structure. The first material is ideal for hypersonic vehicles and had, for example, been used since 1981 on the leading edge of the orbiter's wings because of its ability to maintain its strength above 3,000 degrees Fahrenheit (1,649 C). Carbon-silicon-carbide was at the time an experimental compound with different characteristics; it and carbon carbon were seen as complementary in this case.⁵⁴² The new material would be both the hot structure for thermal protection and a

⁵³⁸ W. Lance Richards, *Finite-Element Analysis of a Mach-8 Flight Test Article Using Nonlinear Contact Elements*, NASA TM 4796, (Edwards, CA: NASA Dryden Flight Research Center, 1997), 1. See also W. Lance Richards and Richard C. Monaghan, *Analytical and Experimental Verification of a Flight Article for a Mach-8 Boundary-Layer Experiment*, NASA TM 4733, (Edwards, CA: NASA Dryden Flight Research Center, 1996), pp. 1, 2, 4, 5. With a booster launch at roughly 38,000 feet, the cold soak temperature of the leading edge of the glove started at -30 F; within 80 seconds the leading edge of the glove would reach 500 degree Fahrenheit, at Mach 8 and 200,000 feet altitude.

⁵³⁹ William L. Ko, *Open-Mode Debonding Analysis of Curved Sandwich Panels Subjected to Heating and Cryogenic Cooling on Opposite Faces*, NASA-TP-1999-206580, (Edwards, CA: NASA Dryden Flight Research Center, 1999), p. 1.

⁵⁴⁰ Larry D. Hudson and Randolph C. Thompson, *Single-Strain-Gage Force/Stiffness Buckling Prediction Techniques on a Hat-Stiffened Panel*, NASA TM 101733, (Edwards, CA: NASA Dryden Flight Research Center, 1991), p. 2.

⁵⁴¹ *Workshop on Correlation of Hot Structures Test Data with Analysis*, NASA CP 3065, Proceedings held at NASA Ames Research Center, Dryden Flight Research Facility, November 15-17, 1988, (Edwards, CA: NASA Dryden Flight Research Facility, 1988), cited in Michael DeAngelis, "Outbriefing Spanning 7/1/65 to 1/3/01", slide 10, internal document, NASA Flight Loads Laboratory, Armstrong Flight Research Center.

⁵⁴² Pursuing thermal protection materials that have better impact resistance, researchers have looked at a variety of materials in the category of elastomeric heat shielding. Among them is silicon. "Silicone and Nitrile rubber based ablative materials are the

loads-carrying structure.⁵⁴³

An enduring effort within the Agency to develop lower cost alternatives for access to space also drove different research at the Center. This included the Linear Aerospike SR 71 Experiment project (LASRE) - an engine the type of which the X-33 was expected to use - and a dual-bell (altitude compensating) nozzle.⁵⁴⁴ In both cases the point was to move beyond the limitations of current rocket technology with fixed bells optimized for a given range in altitude. While relatively simple compared to some of the alternatives, bell-shaped nozzles lose efficiency as the rocket ascends due to the drop in dynamic pressure (q). A linear aerospike, with two flat sides down which the plume travels (the exhaust plume travels down both sides of a plate), allows changing atmospheric pressure to constrict the engine exhaust, in effect making the atmosphere the rest of the nozzle. (The Center flew a scaled version of the vehicle with eight test cells, on the back of an SR-71.) An altitude-compensating nozzle, by comparison, is typically a dual-bell chamber so that the exhaust functions in two stages set for different altitudes (different dynamic pressures).

During the 1980s the Center Flight Loads Laboratory tested different materials and structures for hypersonic vehicles, developing baseline information for validating and predictive tools. And because it had the only capable launch aircraft in the Agency, the Center played an integral role in the X-43 program, the first integrated hypersonic scramjet.⁵⁴⁵ This project joined NASA and industry, with several Centers contributing expertise and capabilities. Flight two of the X-43 reached Mach 7 and, more importantly, demonstrated that such a propulsion system could generate thrust in this configuration sufficient to overcome drag at that speed. Flight three reached just under Mach 10. The Laboratory has also conducted testing of the Hypersonic Inflatable Aerodynamic Decelerator (HIAD). The HIAD concept is for a series of different sized tori stacked on top of each other to inflate during atmospheric entry to a planet such as Mars or Earth, decelerating a payload from hypersonic speeds to the point at which a parachute can arrest the final descent.⁵⁴⁶ And in the first decade of the new century the Center served as the integrator for Pad Abort 1 Test (PA-1) of the Orion Launch Abort System. This was to help certify the new astronaut capsule intended to fly on the new heavy-lifter Space Launch System.⁵⁴⁷

In aeronautics, the PRANDTL-D project (Preliminary Research Aerodynamic Design to Lower Drag) has yielded a wing with a new spanloading that incurs no adverse yaw; the group is working on PRANDTL-M, a glider based on the same principles but designed to be released in the Martian atmosphere for free flight.⁵⁴⁸ Such an aircraft could, while carrying a camera and flight control system, gather data for later use as it descends to the surface. The Center is also developing a scaled rocket-carrying glider to demonstrate the economy of launching small satellites into orbit from a booster carried on a glider and towed to launch altitude. The Towed Glider Air Launch System (TGALS) is a proof-of-concept project using a small airplane towing a twin fuselage glider carrying a rocket. The rationale is that carrying a rocket and payload aloft on a glider is more efficient than carrying a similar rocket and payload aloft on a powered launch aircraft, as NASA did with its NB-52B and Orbital Sciences does with its L-1011 Stargazer and Pegasus[®] booster.⁵⁴⁹ Moreover, because the full-scale glider is meant to be modular, launches could take place from almost anywhere on Earth, allowing high inclination launches or catering to customers who would otherwise need to ride on a much larger booster. In the latter case, smaller payloads fly on the primary customer's schedule and initial developments in the elastomeric matrix system due to their high strain rate with reduced thermal stresses." P. Sanoj and Balasubramanian Kandasubramanian, *Journal of Composites*, Vol. 2014 825607, March 6, 2014. <http://www.hindawi.com/journals/jcomp/2014/825607/>, accessed March 29, 2015.

⁵⁴³ Natalie D. Spivey, *High-Temperature Modal Survey of a Hot-Structure Control Surface*, NASA TM 215965, (Edwards, CA: NASA Dryden Flight Research Center, 2011), pp. 2, 8-9.

⁵⁴⁴ Daniel S. Jones, Joseph H. Ruf, and Trong T. Bui, *Conceptual Design for a Dual-Bell Rocket Nozzle System Using a NASA F-15 Airplane as the Flight Test Bed*, TM-2014-218376, (Edwards, CA: Armstrong Flight Research Center, 2014). The dual-bell nozzle was first conceived at the Jet Propulsion Laboratory (now NASA JPL), in 1949.

⁵⁴⁵ Roger A. Fields, Lawrence F. Reardon, and William H. Siegel, *Loading Tests of a Wing Structure for a Hypersonic Aircraft*, NASA TP-1596, (Edwards, CA: NASA Dryden Flight Research Center, 1980), p. 1.

⁵⁴⁶ http://www.nasa.gov/centers/armstrong/news/X-Press/hiad_06_14.html, accessed May 28, 2016.

⁵⁴⁷ Daniel S. Jones, *The Orion Pad Abort 1 (PA-1) Flight Test: A Propulsion Success*, TN-18252, (Edwards, CA: NASA Armstrong Flight Research Center, 2015).

⁵⁴⁸ <https://ntrs.nasa.gov/search.jsp?R=20160003578>, accessed March 15, 2017. See also <http://www.space.com/33906-nasa-mars-airplane-prandtl-test-flight-photos.html>, accessed March 15, 2017, and https://www.nasa.gov/centers/armstrong/features/mars_airplane.html, accessed March 15, 2017.

⁵⁴⁹ Presenters sometimes ask by way of analogy which is easier: walking a mile carrying 50 pounds or pulling a wagon a mile with 50 pounds in it.

flight path, giving the customers smaller or no say over where or when they will go. The TGALS could offer low-cost rocket launches from almost anywhere, customizing the service to a degree never seen before.

Center engineers have also worked at developing and validating a Fiber Optic Strain Sensing (FOSS) system for use on rocket cryogenic tanks. That effort showed the ability to measure liquid levels in the tanks at .25-inch (.635 cm) increments, far superior to current methods that measure discrete levels only.⁵⁵⁰ This work stemmed from earlier work with FOSS embedded in an airplane that gathered nearly 2,000 strain measurements in real time.⁵⁵¹ “Sensing is not limited to strain; other parameters such as temperature, pressure, shape and loads can be measured with a fiber optic sensing system,” said AFRC engineer Alan Parker. Meanwhile, a fiber optic sensing system is in use on one of the Center GIIIs, which the Air Force Research Laboratory and NASA are using to monitor the strain distribution and shape of the Active Compliant Trailing Edge flap (ACTE).⁵⁵² In 2013 the Center used one of its F-18s to carry the Adaptive Augmenting Controller, “designed to adjust autonomously to unexpected conditions during actual flight.” This system is expected to “make real-time adjustments to the autopilot,” improving the rocket’s efficiency and safety in flight.⁵⁵³

All of this work underscores the Center’s long and continuing experience with access to space, as well as its diverse capabilities. It is not simply a research center focusing on atmospheric flight. And while the shuttle program is complete, the Center remains well positioned for a role in the next phases of spaceflight.

⁵⁵⁰ “Fiber Optic Sensing,” <https://www.nasa.gov/feature/fiber-optic-sensing>, accessed May 28, 2016.

⁵⁵¹ W. Lance Richards, Allen R. Parker, William L. Ko, Anthony Piazza, and Patrick Chan, *Application of Fiber Optic Instrumentation*, North Atlantic Treaty Organization-Research and Technology Organization AGARDograph 160 Flight Test Instrumentation Series-Volume 22, SCI 228, (RTO/NATO, 2012), pp. 6, 2.

⁵⁵² Jay Levine, “Fiber Optic Sensors: Parker’s Algorithm Shatters a Technology Barrier,” *Dryden X-Press Aerovations*, August 5, 2011, pp. 6-7.

⁵⁵³ Jay Levine, “SLS System Evaluated,” *Dryden X-Press*, Vol. 55, No. 9, (November 2013).

Appendix A

Community vs. an Incommensurable Idea

There is more to Theodorsen's double rejection of Jones' swept wing paper than lost conference proceedings or a forgotten journal article—and Theodorsen is not the object of pillory here. Given a pre-existing argument for such a wing as a solution to the problems of high-speed flight and Theodorsen's and his colleagues' vast experience in aeronautics, it is important to ask why a rightfully well-respected theoretical and practical engineer objected so strenuously to Jones' argument.⁵⁵⁴ Theodorsen was the senior member of the peer review committee and his objection carried the heaviest weight, reflecting that institution's hierarchical nature, but he was not the only one who had trouble with Jones' argument: that same theory failed to register with Jacobs, von Kármán, or Dryden, all of whom heard Busemann's presentation in person.⁵⁵⁵ No one in the NACA's Paris Office thought much of the idea, either.

When trying to answer this question we benefit from the sociology of knowledge, and one example in particular from the history of science.

In 1935 Ludwik Fleck published *Genesis and Development of a Scientific Fact*.⁵⁵⁶ Printed in German by a Swiss publishing house, the book received little notice outside the medical community. A respected Polish bacteriologist specializing in immunology, Fleck used the evolution of syphilis' treatment to make a broader argument, which may have thrown a wider audience off the track. ("How can such a book be?" was one reaction: "a fact is a fact. It has neither genesis nor development."⁵⁵⁷) But his underlying points about the sociology of knowledge would surely have set people talking had more paid attention to the book. "To many scientists just as to many historians and philosophers of science facts are things that simply are the case: they are discovered through properly passive observation of natural reality," wrote historian of science Steve Shapin decades later. "Fleck replies that facts are invented, not discovered."⁵⁵⁸ To Fleck, a fact's "creation" is unconnected to physics or biology: it is rooted in the specialists who discover it since it is theirs to interpret and define, theirs to value. How they interpret this fact depends on who they are—economically, socially, religiously, politically, culturally, even geographically. All these and more influence what importance the specialists give their fact, where they place it on the list of problems—if they perceive it as a problem—or solutions, and so on. His point was "to demonstrate to what extent even 'scientific facts' are dependent on history and culture."⁵⁵⁹ Fleck was not alone: others in the field of the sociology of knowledge had been saying much the same thing. Said Karl Mannheim: "every item of historical knowledge is determined by a particular historical perspective:" it is influenced by the social and historical milieus in which it originates.⁵⁶⁰

Fleck wrote of "thought collectives," communities of people using a common language and exchanging ideas and holding common principles. "Long-lasting collectives create social institutions which enable and regulate the method by which [the] next generations are added to a given collective: educational systems and social rituals accompany the admission of new members. Members of a thought collective naturally possess a certain bond," wrote Wojciech Sady in an exposition of Fleck's argument.⁵⁶¹ But, Fleck

⁵⁵⁴ "In 1931 Theodorsen described a "Theory of Wing Sections of Arbitrary Shapes" which made it possible, as long as the flow did not separate from the airfoil, to predict pressure distributions of an airfoil ... this clever double transformation later suggested the answer to the riddle of how to shape a laminar-flow airfoil." James R. Hansen, *Engineer in Charge*, pp. 105-106.

⁵⁵⁵ Historian James R. Hansen, who has written extensively about the Langley Research Center, suspects that once Theodorsen spoke on the matter "no one else on the committee would have spoken up against his position." Hansen, email correspondence with Christian Gelzer, February 3, 2017. Jacob Ackeret's role in designing the wing, and particularly the wing tips of the Miles M.52, along with continued research on Busemann's concept in Germany, suggest the American contingent was the outlier in this case.

⁵⁵⁶ Ludwik Fleck, *Genesis and Development of a Scientific Fact*, edited by Thaddeus J. Trenn and Robert K. Merton, translated by Fred Bradley and Thaddeus J. Trenn, Foreword by Thomas S. Kuhn, (Chicago, IL: University of Chicago Press, 1979, paperback 1981; originally published by Benno Schwabe & Co., Basel, Switzerland, 1935).

⁵⁵⁷ Fleck, *Genesis and Development of a Scientific Fact*, p. viii.

⁵⁵⁸ Steven Shapin, Science, <http://www.press.uchicago.edu/ucp/books/book/chicago/G/bo25676016.html>, accessed February 2, 2017.

⁵⁵⁹ Robert S. Cohen and Thomas Schnelle, *Cognition and Fact: Ludwik Fleck, 1896-1961*, (Dordrecht, Holland: Reidel Publishing Company, 1986).

⁵⁶⁰ Karl Mannheim, *Essays on the Sociology of Knowledge*, edited by Paul Kecskemeti, (London: Routledge & Kegan Paul, Ltd., 1952; first published as six essays between 1923 and 1929), pp. 102-4. See also Peter L. Berger and Thomas Luckmann, *The Social Construction of Reality: A Treatise in the Sociology of Knowledge*, (Garden City, New York: Anchor Books, 1966).

⁵⁶¹ Wojciech Sady, Stanford Encyclopedia of Philosophy, <https://plato.stanford.edu/entries/fleck/>, accessed February 2, 2017. Those who study him, notes Jonathan Harwood, "regard Fleck as the first writer to make a sustained case for a sociology of scientific knowledge."

cautioned, those who are at odds with the thought collective pay a penalty. When a contrary argument or theory persists, it results in an “incommensurability.” The consequences for incommensurability: the thought collective might “burn dissenters at [the] stake,” sometimes literally.⁵⁶² We can put all this in a familiar context.

In the late 19th and early 20th centuries communities of like-minded individuals interested in aeronautics emerged—the Aeronautical Society of Great Britain, for example, founded in 1866. The field was in its infancy and so were its science and language. Addressing the Western Society of Engineers in 1901, Wilbur Wright spoke of “sudden collapse” (stall), “main bearing surface” (wing), “drift” (drag), and “double-decker” (bi-plane), and his is hardly the only example we can point to. After Louis Breguet read a paper (in English) at the Royal Aeronautical Society in 1921, a member of the audience spoke up: “The efficiency factor he assumed corresponded to our English L/D. Although there were exceptional cases where the technical experts in the two countries did speak each other’s languages, the majority did not, but it was obviously desirable that they should all think in the same mathematical language.” As many will remember, Breguet’s term for efficiency (L/D) was “fineness.”⁵⁶³

Yet from these few came formal social and professional societies, as well as journals—*The Aeronautical Journal* (UK), *Flight* (US), *L’aeronaute* (FR), *L’Aeronauta* (IT), and *Luftfahrtforschung* (GR). Eventually formal institutions emerged that focused on this new field to “furnish constants, laws, formulas, and empirical data of substantial and permanent value to the engineer,” institutions vital to shaping the next generation of the discipline’s professionals.⁵⁶⁴

In time those who become members of this larger society (“thought collective”) perforce, subscribe to the common tenets and language. Subsequent generations are taught the society’s language and core principles and in turn, are able to participate in the society’s activities and benefits. In his 2011 book, *The Enigma of the Aerofoil: Rival Theories in Aerodynamics, 1909-1930*, David Bloor offers one of the better descriptions of the turmoil associated with the early stages of this “thought collective’s” development and its solidification.⁵⁶⁵

But what to do with a member in good standing who asserts an idea that challenges the established tenets of the body—an incommensurability—as Jones was doing in 1945? Fleck is very clear: the larger body moves to protect its principles—to keep discipline and assert common sense. Emile Durkheim described it as “the force exerted on the individual by social structures both as objective facts and as controlled behavior.”⁵⁶⁶ Historian of science Thomas Kuhn pointed out that “Copernicanism made few converts for almost a century after Copernicus’ death. Newton’s work was not generally accepted, particularly on the Continent, for more than half a century after the *Principia* appeared. Priestly never accepted the oxygen

Jonathan Harwood, “Ludwik Fleck and the Sociology of Knowledge,” *Social Studies of Science* (SAGE) Vol. 16 (1986): pp. 173-187.

⁵⁶² Sady, Stanford Encyclopedia of Philosophy, <https://plato.stanford.edu/entries/fleck/>, accessed February 2, 2017.

⁵⁶³ Wilbur Wright, “Some Aeronautical Experiments,” presented to the Western Society of Engineers, September 18, 1901, *Annual Board of Regents of the Smithsonian Institution, Showing the Operations, Expenditures, and Condition of the Institution for the Year Ending June 30, 1902*, (Washington, D.C.: U.S. Government Printing Office, 1903), pp. 133-148, https://books.google.com/books?id=0_UyAQAAAJ&pg=PA133&lpg=PA133&dq=Wilbur+Wright,+%E2%80%9CSome+Aeronautical+Experiments,%E2%80%9D+presented+to+the+Western+Society+of+Engineers,+Sept.+18,+1901&source=bl&ots=I6Z5qGLH1h&sig=bhx6bpDx4k_72wb5awGqfh1_mCA&hl=en&sa=X&ved=0ahUKewiHn9Oj9sTTAhVG6CYKHaAoBM4Q6AEIPTAG#v=onepage&q=Wilbur%20Wright%2C%20%E2%80%9CSome%20Aeronautical%20Experiments%2C%20%E2%80%9D%20presented%20to%20the%20Western%20Society%20of%20Engineers%2C%20Sept.%2018%2C%201901&f=false, accessed March 23, 2017. Louis Breguet, “Aerodynamical Efficiency and the Reduction of Air Transport Costs,” *Aeronautical Journal* (August 1922): 307-320. Proceedings. Twelfth Meeting, 57th Session [Royal Aeronautical Society, Britain], in James R. Hansen, ed., *The Wind and Beyond: A Documentary Journey into the History of Aerodynamics in America*, Vol. 2, (Washington, D.C.: NASA, 2007), pp. 102-118. This uniformity or consensus is true only up to a point: remarkably, something as critical as the x, y, z axes remains inconsistently defined within the aeronautical community. The British did not settle on “aeroplane” to define heavier-than-air craft until 1922, a category that included seaplanes and amphibians. *Aviation* 13 Vol. 12, (March 27, 1922), p. 363.

⁵⁶⁴ Roland, citing Albert Zahm “On the Need for an Aeronautical Laboratory in America,” *Aero Club of America Bulletin*, February 1912, p. 35, in Roland, *Model Research*, p. 7.

⁵⁶⁵ David Bloor, *The Enigma of the Aerofoil: Rival Theories in Aerodynamics, 1909-1930*, (Chicago: The University of Chicago Press, 2011). The journal *Aviation* published an editorial on March 27, 1922, lamenting inconsistent terms for the same thing that existed between Britain and the U.S. The best thing they could say about the two nations’ efforts at developing a professional language: its “greatest merit is undoubtedly that it represents a concerted effort toward uniformity.” *Aviation*, Vol. XII, No. 13 (March 27, 1922).

⁵⁶⁶ Fleck, *Genesis and Development of a Scientific Fact*, p. 46. To Durkheim violation of the norm brought on sanctions that could be formal (legal) or informal (social control), which might include exclusion from a group. <http://www.colorado.edu/Sociology/gimenez/soc.5001/durk1.html>, accessed April 24, 2017.

theory, nor Lord Kelvin the electromagnetic theory.” Max Planck conceded about his own career that a new theory did not win over converts so much as wait for “its opponents to die,” after which a new generation could arise that was familiar with, and not hostile to, the idea.⁵⁶⁷ (In 1921 Brig. Gen. Billy Mitchell used a WWI bomber to sink the former German battleship *Ostfriesland*. The message was clear: capital ships were obsolete. The Army and Navy “refused to recognize [the new] reality [and] dismissed” Mitchell and his message outright.⁵⁶⁸) Jones’ case was not much different: the solution was to reject the claim by denying the claimant a chance to be heard.

On the 50th anniversary of Kuhn’s *The Structure of Scientific Revolutions* (2012), a book with striking parallels to Fleck’s, John Naughton looked back at its impact and reminded us of the phases Kuhn saw in scientific development, the first of which was “normal science.” “In this phase,” wrote Naughton,

a community of researchers who share a common intellectual framework – called a paradigm or a “disciplinary matrix” – engage in solving puzzles thrown up by discrepancies (anomalies) between what the paradigm predicts and what is revealed by observation or experiment. Most of the time, the anomalies are resolved either by incremental changes to the paradigm or by uncovering observational or experimental error. As philosopher Ian Hacking puts it in his terrific preface to the new edition of *Structure*: ‘Normal science does not aim at novelty but at clearing up the status quo. It tends to discover what it expects to discover.’ The trouble is that over longer periods unresolved anomalies accumulate and eventually get to the point where some scientists begin to question the paradigm itself. At this point, the discipline enters a period of crisis characterised [sic] by, in Kuhn’s words, “a proliferation of compelling articulations, the willingness to try anything, the expression of explicit discontent, the recourse to philosophy and to debate over fundamentals.” *In the end, the crisis is resolved by a revolutionary change in world-view in which the now-deficient paradigm is replaced by a newer one.* [emphasis added] This is the paradigm shift of modern parlance and after it has happened the scientific field returns to normal science, based on the new framework. And so it goes on.⁵⁶⁹

Both Kuhn and Fleck provide tools to understand group and individual activity and thought in professional societies such as the one to which Jones belonged. Fleck insisted on the importance of the context in which researchers work: their social standing, education, language, and more. Why? Because all factor into how one describes something. How we define a “fact” determines what we do with it.⁵⁷⁰ This remains Fleck’s most troublesome assertion for some, but it was something Kuhn echoed. (Those in the communities of the sociology of science, history of science, and the history of technology have wrestled with this for several

⁵⁶⁷ Thomas Kuhn, *The Structure of Scientific Revolutions*, (Chicago: The University of Chicago, 1962; 4th edition, 2012), pp. 149-150. Kuhn’s book appeared the year Fleck died. In it he admitted that many of his ideas were anticipated by Fleck. In 1979 R. T. Jones wrote that “the scientific community most qualified for action at the forefront of human endeavor often turns out in practice to be the most conservative.” R. T. Jones, compiler, *Classical Aerodynamic Theory*, NASA Reference Publication no. 1050, (Moffett Field, CA: Ames Research Center, 1979), p. iii.

⁵⁶⁸ Mike Lorrey, “The Legal Mandate for a U.S. Space Force,” *SpaceNews* 8 October 2018: p. 28.

⁵⁶⁹ John Naughton, “Thomas Kuhn: The Man Who Changed the Way the World Looked at Science,” *History of Science, The Observer* Saturday August 18, 2012, <https://www.theguardian.com/science/2012/aug/19/thomas-kuhn-structure-scientific-revolutions>, accessed February 3, 2017. Jonathan Harwood is unequivocal about the etymology of the sociology of knowledge of science: “Fleck anticipated fifty years ago many of the current arguments for a sociology of scientific knowledge ... which have derived largely from Kuhn.” Harwood, “Ludwik Fleck and the Sociology of Knowledge,” pp. 173-175.

⁵⁷⁰ Consider adverse yaw, which the Wrights discovered and solved with their 1902 glider. Explaining the problem’s cause waited for Ludwig Prandtl and the lifting line theory. Adverse yaw is a feature of the elliptical spanload, but not a devastating one requiring new research, a ‘problem’ designers work around by adding drag, even structure, but not so critical a problem that one needs safety features (parachutes) in order to fly. No one (excepting one failed attempt) has thought it worth genuinely researching: to the relevant ‘thought collective’ the matter is long settled. And yet, one NASA researcher, bothered by the ‘fact,’ has designed and built a flying wing that generates no adverse yaw—and is 11.5% more efficient than the elliptically loaded wing. The reactions have been a blend of Copernicus, Newton, Priestly, and Kelvin. Albion H. Bowers and Oscar Murillo, Robert “Red” Jensen and Brian Eslinger, and Christian Gelzer, *On Wings of the Minimum Induced Drag: Spanload Implications for Aircraft and Birds*, NASA TP 2016-219072: <https://www.google.com/#q=On+Wings+of+the+Minimum+Induced+Drag:+Spanload+Implications+for+Aircraft+and+Birds%2C+NASA+TP+2016-219072>, accessed May 30, 2018.

decades, even if the idea may yet set some readers back on their heels.⁵⁷¹) But coming to terms with a systemic, cultural, and yes—thought collective—rejection of, or indifference to what turned out to be a monumentally significant concept is hard if not impossible to understand any other way.

⁵⁷¹ See for example Trevor J. Pinch and Wiebe E. Bijker, “The Social Construction of Facts and Artefacts: Or How the Sociology of Science and the Sociology of Technology Might Benefit Each Other,” *Social Studies of Science*, Vol. 14, No. 3 (August 1984), pp. 399-441; Bruno Latour, *Science in Action: How to Follow Scientists and Engineers Through Society*, (Cambridge: Harvard University Press, 1987), and Loren R. Graham, *The Ghost of the Executed Engineer: Technology and the Fall of the Soviet Union*, (Cambridge, MA: Harvard University Press, 1993).

Sources

Primary

A History of Significant Research at NASA Langley's Aircraft Landing Dynamics Facility. [n.a.] NASA/XX-2008-XXXXX, October 2008.

Adkins, Jim. Letter to Betty Love. August 30, 2002. Personal collection.

"An Approach to Manned Orbital Flight." Bell Report D143-945-700. Presented to the Committee on Advanced Weapons Technology and Environment of the U.S. Air Force Scientific Advisory Board, 29–30 July 29-30, 1957.

Andrews, W. H. "Space Shuttle Orbiter Approach & Landing Test – Mated Inert Flight Test Plan." NASA DFRC, Edwards, CA, January 28, 1977.

Approach and Landing Test Evaluation Team. "Space Shuttle Orbiter Approach and Landing Test – Final Evaluation Report." JSC-13864. Houston, TX: NASA Johnson Space Center, February 1978.

Armstrong, Neil. Pilot report, [X-1B] Flight 14, August 15, 1957, [X-1B] Flight 16, January 16, 1958. File L1-3-11A-3. NASA AFRC Historical Reference Collection.

_____. NASA MSC Minutes of Meeting of Flight Readiness Review Board, Lunar Landing Training Vehicle. Houston, TX: NASA Manned Spacecraft Center, January 12, 1970.

Arnold, Henry "Hap" correspondence to Vannevar Bush, chairman NRDC. February 25, 1941. National Archives Record Group 255, Washington, D.C.

Atmajian, Timothy K. email correspondence with Christian Gelzer. "Dryden's Contributions to the Shuttle Program Notes." NASA AFRC Historical Reference Collection.

Baer-Riedhart, Jenny. Oral History Interview, January 13, 2002. NASA AFRC Historical Reference Collection.

Baron, Bob, Oral History Interview with Curtis Peebles, Alan Brown, and John Nelson, December 27, 2001. NASA AFRC Historical Reference Collection.

Bender, Karl, conversation with Christian Gelzer, NASA Armstrong Research Library, December 23, 2015.

_____, conversation with Christian Gelzer, December 8, 2016.

_____, email to Christian Gelzer, December 16, 2014.

Bowers, Albion, and Nalin Ratnayake, email correspondence with Christian Gelzer regarding lift-to-drag nomenclature in aeronautical literature, December 12-13, 2011, and January 26 27, 2012. "Dryden's Contributions to the Shuttle Program Notes." NASA DFRC Historical Reference Collection.

Bowers, Albion, conversation with Christian Gelzer, November 16, 2016.

_____, email correspondence with Christian Gelzer regarding lift-to-drag (L/D) nomenclature in aeronautical literature. NASA DFRC, December 13, 2011. "Dryden's Contributions to the Shuttle Program Notes." NASA AFRC Historical Reference Collection.

_____, interview with Christian Gelzer, September 24, 2014. NASA Armstrong Flight Research Center.

Brewer, Rick, telephone interview with Christian Gelzer, January 30, 2012. NASA AFRC Historical Reference Collection.

Busemann, Adolph. "Einen langen Brief an Ludwig Prandtl, November 18, 1929." AMPG, Abt. III, Rep. 61, Nr. 219. In Michael Eckert, *Ludwig Prandtl: Strömungsforscher und Wissenschaftsmanager, ein unverstellter Blick auf sein Leben.* Berlin: Springer-Verlag, 2017.

Bryant, Roy Collection. Flight Request [YF-104]. Series: 961 to 990. September 5, 1985. L5-5-3C, NASA AFRC Historical Reference Collection.

Bryant, Roy, telephone interview with Curtis Peebles, March 16, 2004, NASA Dryden Flight Research Center.

Carter, A. L. Memorandum to Milton O. Thompson, chief engineer re. "Review of Shuttle Carrier Aircraft (SCA) Structural Issues." July 13, 1977. File Folder L2-1-3A-2, Space Shuttle Files. NASA AFRC Historical Reference Collection.

Carter, John F. and Christopher J. Nagy. Notes to Christian Gelzer on the LSRA history, June 3, 2011. "Dryden's Contributions to the Shuttle Program Notes." NASA AFRC Historical Reference Collection.

Chandler, Michael. Written Recollections, email correspondence with George Grimshaw, January 2012. NASA AFRC Historical Reference Collection.

Chou, Richard Shih-Shien. "The Airdocs' Perspective: Naval Flight Surgeons Contributions." "Dryden's Contributions to the Shuttle Program Notes." NASA AFRC Historical Reference Collection.

Chalk, C. R. and P. A. Reynolds. "Test Plan – Simulation of Orbiter Landing Characteristics in the USAF Total In-Flight Simulator (TIFS)." TIFS Memo No. 844. Calspan Corporation, May 25, 1978.

Chart: F-104 #961 Reaction Control Airplane. F-104 Notebook. File L1-3-10B-3. NASA AFRC Historical Reference Collection.

Convegno di Scienze Fisiche, Matematiche e Naturali: Le Alte Velocità in Aviazione, 30 Settembre – 6 Ottobre, 1935-XIII. Roma: Reale Accademia D'Italia, 1936-XIV. NASA Armstrong Flight Research Center Research Library.

Crippen, Robert, conversation with Jay Levine, 15 April 2011. NASA Dryden Flight Research Center.

Crocco, Arturo. Closing remarks to the Vth Volta Congress. *Convegno di Scienze Fisiche, Matematiche e Naturali: Le Alte Velocità in Aviazione*, 30 Settembre – 6 Ottobre, 1935-XIII. Roma: Reale Accademia D'Italia, 1936-XIV.

Crossfield, A. Scott, interviewed by Peter Merlin, February 3, 1998. NASA AFRC Historical Reference Collection.

D'Agostino, Joseph, interviewed by Christian Gelzer, June 6, 2011. Shuttle Documentary History. NASA Armstrong Oral History Collection.

Daily Log [Green Books], 1989 and 1992. File Folders L3-9-7 and L3-9-8B. NASA AFRC Historical Reference Collection.

Dana, William H., oral history interview. NASA Armstrong Flight Research Center Oral History Collection.

_____, correspondence with Christian Gelzer, January 6, 2003. NASA AFRC Historical Reference Collection.

Day, Richard E. "Cold War Jets Study (A Legacy Resource Management Project) Edwards AFB, Kern County, California, Oral History Transcript. Edwards, CA: Computer Sciences Corporation, 1995. Limited Distribution.

"DFRC Orbiter Landing Investigation Team Final Presentation." August 1978. Milton O. Thompson Collection. File Folder L1-5-7-22. NASA AFRC Historical Reference Collection.

Dryden, Hugh L. "Report of the Director of Aeronautical Research submitted to the National Advisory Committee for Aeronautics, submitted at its annual meeting, October 23, 1947. In Alex Roland. *Model Research*. Vol. 1. Washington, D.C.: NASA, 1985.

Engle, Joe H., interviewed by Rebecca Wright, Houston, TX, May 27, 2004. NASA Johnson Space Center Oral History Project.

"F-15B Lifting Insulation Foam Trajectory (LIFT) Flight Test: Phase 1—Design and Ground Test Review." NASA Dryden Flight Research Center, November 5, 2004.

Freitag, Hank, email to Christian Gelzer, April 28, 2015.

Fullerton, C. Gordon, conversation with Peter Merlin, September 2006.

_____, interviewed by Rebecca Wright, NASA Dryden Flight Research Center, May 6, 2002. NASA Johnson Space Center Oral History Project Oral History.

_____, Oral History Interview, December 2007. NASA AFRC Historical Reference Collection.

Gelzer, Christian. "Casualty White Paper," April 12, 2012. "Dryden's Contributions to the Shuttle Program Notes."

_____. "The D-558-II." Presented at the Experimental Aircraft Association's AirVenture, Oshkosh, July 30, 2003.

Gilruth, Robert R. Letter to Dale D. Meyers. June 29, 1970.

_____. Letter to Dale D. Meyers. July 8, 1970.

Grimshaw, George, email correspondence with Christian Gelzer. March 2012. NASA AFRC Historical Reference Collection.

_____, email correspondence with Christian Gelzer, April 5, 2012. "Dryden's Contributions to the Shuttle Program Notes." NASA AFRC Historical Reference Collection.

_____, interview with Erika Fedorko, NASA Dryden Shuttle Documentary, July 2011. NASA AFRC Historical Reference Collection.

_____. "Supporting Shuttle at Dryden – 35 Years of Excellence at Dryden." November 2012. "Dryden's Contributions to the Shuttle Program Notes." NASA AFRC Historical Reference Collection.

_____, notes to Christian Gelzer, June 2011. "Dryden's Contributions to the Shuttle Program Notes." NASA AFRC Historical Reference Collection.

Grimshaw, George and Harry Talbot. Written recollections. Email correspondence with George Grimshaw. March 2012.

Grimshaw, George and Larry Biscayart. Oral History, April 2007. NASA AFRC Historical Reference Collection.

Guoan, William T., email correspondence with Christian Gelzer, January 30, 2017.

_____, notes to Christian Gelzer, January 27, 2017.

Haise, Jr., Fred W., interviewed by Doug Ward, Houston, TX, March 23, 1999. NASA Johnson Space Center Oral History Project.

Hallion, Richard P. Notes from an interview with Robert T. Jones. July 14, 1977. AFRC Reference Collection.

Hansen, James R., email correspondence with Christian Gelzer, February 3, 2017.

Harness, Mary Ann C., conversation with Gordon Fullerton, June 19, 2012.

Hoey, Robert. G., email correspondence with Christian Gelzer concerning Reaction Controls System work at the NACA High Speed Flight Station, September 26, 29, 2014.

_____. "Flight Test Results from the Entry and Landing of the Space Shuttle Orbiter for the First Twelve Orbital Flights." AFFTC-TR-85-11. Office of Advanced Manned Vehicles, Edwards, CA, June 1985.

_____. "Testing Lifting Bodies at Edwards." *Air Force/NASA Lifting Body Legacy History Project*. PAT Projects, Inc., 1994.

Hoffman, Jeffrey. *16.885J Aircraft Systems Engineering*, Fall 2005. Massachusetts Institute of Technology: MIT OpenCourseWare, <http://ocw.mit.edu>, accessed May 19, 2011.

Hogue, Jim, Brig. Gen. ret., email correspondence with George Grimshaw, April 2012.

Hudson, Larry, interviewed by Christian Gelzer and Jay Levine, June 13, 2014. NASA Armstrong Flight Research Center Oral History Collection.

Ide, John Jay. "Report on Visit to Germany." October 23, 1936. Floyd L. Thompson Technical Library, Langley Research Center, Hampton, VA. In James R. Hansen, *Engineer in Charge: A History of the Langley Aeronautical Laboratory, 1917-1958*. Washington, D.C.: NASA, 1987.

Jenkins, Dennis R., Definitions of Space. Text prepared for the astronaut wings ceremony for William H.

“Bill” Dana, John B. “Jack” McKay, and Joseph A. “Joe” Walker held at the Dryden Flight Research Center, August 23, 2005. NASA AFRC Historical Reference Collection.

_____, email correspondence with Christian Gelzer, April 14, 2015, August 19, 2016, May 26, 2011, September 18, 2014, August 14, 2018. NASA AFRC Historical Reference Collection.

_____, email correspondence with Christian Gelzer, March 24, 2014, citing “Mechanical, Maintenance, Arm & Crew Systems (MMACS) Console Handbook,” Volume IV: Mechanisms, JSC-28922, April 1, 2007. NASA AFRC Historical Reference Collection.

Jensen, Robert “Red”, email to Christian Gelzer, January 30, 2017.

JF-104A Flight Logs 1956-1961, 1-169. File L1-3-10B-1. NASA AFRC Historical Reference Collection.

Jones, R. T. Correspondence to Ernest O. Pearson. February 2, 1960. AFRC Historical Reference Collection.

Jones, Walton L. letter to Floyd L. Thompson, Chairman, Apollo 204 Review Board, February 24, 1967. Containing memo from Donald Bellman to Associate Director, “Comments on Cockpit Environments Used in Research Airplanes at the Flight Research Center.” February 8, 1967. AFRC Reference Collection.

Kahl, Robert H., interviewed by Rebecca Wright, Downey, California – 25 August 2010. NASA STS Recordation Oral History Project, Edited Oral History Transcript. http://www.jsc.nasa.gov/history/oral_histories/STS-R/KahlRH/KahlRH_8-25-10.htm, accessed January 23, 2012.

_____. Question posed during Vth Volta Congress. *Convegno di Scienze Fisiche, Matematiche Naturali: Le Alte Velocità in Aviazione*, 30 Settembre – 6 Ottobre, 1935-XIII. Roma: Reale Accademia D’Italia, 1936-XIV.

Knutson, Arvid, interviewed by Guy Noffsinger. Shuttle Documentary Interviews, October 2010, NASA Dryden. NASA AFRC Historical Reference Collection.

Kraft, Jr, Christopher C. to Isaac T. Gillam, Director Hugh L. Dryden Flight Research Center, October 17, 1979. “Elevon Seals System Test,” PD 78-8. NASA Dryden Flight Research Center, 1979.

Lewis, George. “Report on Trip to Germany and Russian [sic], September-October 1936.” E32 12 LCD. Undated manuscript, 22 pp., with 10 pp, handwritten notes. In Alex Roland, *Model Research: The National Advisory Committee for Aeronautics, 1915-1958*. Vol. 1. Washington, D.C.: NASA, 1985.

“Lifting Insulation Foam Trajectory (LIFT) Flight Test.” Objectives & Requirements Document (ORD) 04-001, v.1, February 2, 2005. NASA Dryden Flight Research Center.

Love, Betty, interviewed by Curtis Peebles December 23, 2003. Personal collection.

Lorrey, Mike. “The Legal Mandate for a U.S. Space Force.” SpaceNews 8 October 2018.

“Management Plan: Orbiter Elevon Seals System Test Program at DFRC,” Spacecraft Design Division, Mechanisms Branch, Johnson Space Center. [n.d.]

McCarthy, Frank, email correspondence to Harry Talbot, June 7, 2011. “Dryden’s Contributions to the Shuttle Program Notes.” NASA AFRC Historical Reference Collection.

McMurtry, Tom, interviewed by Guy T. Noffsinger. Shuttle Documentary Interviews, October 2010.

McTigue, John, interviewed by Guy Noffsinger, October 2010. Shuttle Documentary Interview. NASA AFRC Historical Reference Collection.

_____, telephone interview with Christian Gelzer. December 8, 2011.

_____, telephone interview with Curtis Peebles, September 22, 2010.

Meier, Hans-Ulrich, Burghard Ciesia, Hans Försching, Hans Galleithner, Werner Heinzerling, Bernd Krag, and Helmut Schubert. *German Development of the Swept Wing, 1935-1945*. Translated by Egon Stanewsky. Reston, VA: AIAA, 2010.

Meyers, Dale D. Letter to Robert R. Gilruth. May 22, 1970.

_____. Letter to Robert R. Gilruth. June 17, 1970.

Memo from Ames R C to VT-EPD-1/A, Harley/C, and Baker/C, from DoD/R. Eddington, re: STS-6 Support Requirements, April 1, 1983. "Dryden's Contributions to the Shuttle Program Notes." NASA AFRC Historical Reference Collection.

Memo to VT-EPD-1/A, Harley/C, and Baker/C, from DoD/R. Eddington, re: STS-6 Support Requirements, April 15, 1983. "Dryden's Contributions to the Shuttle Program Notes." NASA AFRC Historical Reference Collection.

Memorandum CB-85-437: STS 51D Flight Crew Report [n.d.]. Johnson Space Center.

Memorandum CB-86-001: Memorandum CB-86-001, January 6, 1986, JSC, from CB/Chief of Astronaut Office to CA/Director, Flight Crew Operations, Re: Use of the Shuttle Landing Facility as the End-of-Mission Landing Site—Is the Risk Worth the Gain? AFRC Historical Reference Collection.

Memorandum EW3-76-368 to ME4/D. Lockhard. Subj: Lakebed Tire to Runway Friction Prediction. November 23, 1976. Roy Bryant Collection. File folder L5-5-3C, NASA AFRC Historical Reference Collection.

Meyer, Robert R., Jr., interviewed by Gray Creech, January 19, 2012, NASA AFRC.

_____, interviewed by Guy Noffsinger. Shuttle Documentary Interviews. October 2012, NASA Dryden. NASA AFRC Historical Reference Collection.

Myers, Dale. Lecture 1 in Jeffrey Hoffman, *16.885J Aircraft Systems Engineering*, Fall 2005. Massachusetts Institute of Technology: MIT OpenCourseWare, <http://ocw.mit.edu>, accessed May 19, 2011. License: Creative Commons BY-NC-SA; guest lecturer Dale Meyers.

Minutes of Meetings, Panel for Manned Space Flight, September 24, 30, and October 1958. In John M. Logsdon and Roger D. Launius, eds., *Exploring the Unknown: Selected Documents in the U.S. Civil Space Program. Volume VII Human Spaceflight: Projects Mercury, Gemini, and Apollo*. Washington, D.C.: NASA, 2008.

Munger, William P. interviewed by Frank H. Winter, Jun 18 1987, in *American's First Rocket Company: Reaction Motors, Inc.*, (Reston, VA: AIAA, 2017), pp. 109-115.

Nagy, Chris J. Notes to the Christian Gelzer, October 10, 2011.

NASA safety document [n.a., n.d.]. "Dryden's Contributions to the Shuttle Program Notes." NASA AFRC Historical Reference Collection.

North, Warren J. Johnson Space Center Oral History Project, September 30, 1998. http://www.jsc.nasa.gov/history/oral_histories/NorthWJ/WJN_9-30-98.pdf, accessed July 22, 2012.

Perkins, Courtland D. "Development of Airplane Stability and Control Technology." 1970 Von Kármán Lecture. *Journal of Aircraft* 7 (July-August 1970), No. 4.

Pickrel, Jonathan, email correspondence with Christian Gelzer, May 28, 2016, NASA AFRC.

Pilot's Flight Report, F-104, No. 961, Subject: Initial flight and ground evaluation and operation of reaction control installation. J.A. Walker. [n. d.], F-104 Notebook. File L1-3-10B-1, NASA AFRC Historical Reference Collection.

Pope, H. A. "ALT Manned Simulations – Orbiter/747 Separation." NASA JSC Engineering Analysis Division briefing, Houston, TX, January 20, 1975. Milton O. Thompson Collection. File folder L1-5-2-7, NASA AFRC Historical Reference Collection.

Ramos, Joe, email correspondence with George Grimshaw, April 2012.

Rediess, H. A. "Memorandum to DFRC Shuttle Projects Manager from Director of Research re. Assessment of ALT Tests with Tailcone On vs. Off." Edwards, CA: NASA DFRC, March 17, 1976. File L2-1-3C-6, Space Shuttle files, NASA AFRC Historical Reference Collection.

Reisert, Donald. JF-104 #961 notebook. File L1-3-10A-1, NASA Armstrong Historical Reference Collection.

Request for Proposal 9-BC421-67-2-40P. "Space Shuttle Proposal." Houston, TX: JSC, March 17, 1972.

RFP 9-BC421-67-2-40P. "Space Shuttle Program." Houston, TX: NASA 17 March 1972, IV-6, IV-9. In Dennis R. Jenkins *Space Shuttle: The History of the National Space Transportation System: The First 100 Flights*. 3rd ed. Cape Canaveral, FL: Dennis R. Jenkins, 2002.

Risch, Tim, email to Christian Gelzer, November 3, 2016.

Ross, Jerry, email notes on shuttle related medical staffing, via Dr. Jennifer Ross-Nazzal. "Dryden's Contributions to the Shuttle Program Notes." NASA AFRC Historical Reference Collection.

Roth-Johnson, Perry, conversation with Christian Gelzer, November 22, 2016.

_____, email to Christian Gelzer, November 22, 2016.

Ryan, Bertha M., interviewed by Sandra Johnson and Rebecca Wright, June 13, 2001. NASA Johnson Space Center Oral History Project.

"STS-23 (51-D) tire article." [n.a.] "Dryden's Contributions to the Shuttle Program Notes." NASA AFRC Historical Reference Collection.

Sefic, Walter J., interviewed by Christian Gelzer, May 21, 2014. NASA Armstrong Flight Research Center Oral History Collection.

Seidl, Pete, interviewed by Christian Gelzer, June 13, 2001, NASA TV, Edwards, CA. Shuttle Documentary Interviews. NASA AFRC Historical Reference Collection.

"Space Shuttle Orbiter Management Review. NASA-MSC." SSV72. September 12, 1972.

Stack, John. NACA memorandum to John Crowley. R.A. 1347. June 14, 1945. In Louis Rotundo, *Into the Unknown: The X-1 Story*. Washington, D.C.: Smithsonian Institution Press, 1994.

Stanley, Robert M. Memo from to D. Roy Shoults, Bell Aircraft Corporation. Report of Meeting at Wright Field on March 5-6, 1947.

"Statement of Work: Modification of a NASA CV-990 to a Landing Systems Research Aircraft." NASA. n.d.

Swain, L. Jerry. NASA Johnson Space Center Oral History Project. Interviewed by Jennifer Ross-Nazzal, October 2, 2009. http://www.jsc.nasa.gov/history/oral_histories/SwainLJ/SwainLJ_10-2-09.htm, accessed December 4, 2014.

Szalai, Ken, interview with James Tomayko, June 8, 1998. NASA AFRC Historical Reference Collection.

Talbot, Harry, email correspondence with Christian Gelzer, May 12, 2011. "Dryden's Contributions to the Shuttle Program Notes." NASA AFRC Historical Reference Collection.

_____. Written Recollections, email correspondence with George Grimshaw. March 2012.

Talbot, Harry and Bill Shelton, interviewed by Christian Gelzer, June 7, 2011. "Dryden's Contributions to the Shuttle Program Notes." NASA AFRC Historical Reference Collection.

Thompson, Milton. Correspondence to Robert Thompson, December 17, 1980. Milton Thompson Collection, File Folder L1-5-2-2, NASA AFRC Historical Reference Collection.

_____. "DFRC Flight Investigation of Factors Affecting Orbiter-Type Landings." [n.d.] Handwritten briefing chart. Milton Thompson Collection. File Folder L1-5-2-2, NASA AFRC Historical Reference Collection.

_____. "Features of Candidate A/C for Landing Program," [n.d.]. Milton Thompson Collection. File Folder L1-5-2-2, NASA AFRC Historical Reference Collection.

_____. Notes on "Sequence of events on FF-5 landing." [n.d.] Milton O. Thompson Collection. File folder L1-5-2-2, NASA AFRC Historical Reference Collection.

Thompson, Robert F. Oral History Interview by Kevin M. Rusnak, October 3, 2000, Johnson Space Center Oral History Project. http://www.jsc.nasa.gov/history/oral_histories/ThompsonRF/thompsonrf.htm, accessed November 10, 2016.

"TIFS Program Summary." [n.d.] Milton O. Thompson Collection. File L1-5-2-2, NASA AFRC Historical Reference Collection.

Tseng, Ting, interviewed by Christian Gelzer, NASA AFRC. June 16, 2015.

Walker, J. A. "Pilot's Flight Report F-104, No. 96, Subject: Initial flight and ground evaluation and operation of reaction control installation." [n.d.] F-104 notebook. File L1-3-10A-3, NASA Armstrong Historical Reference Collection.

Whiteside, Walter W., Oral History Interview with Dill Hunley, July 30, 1997. NASA AFRC Historical Reference Collection.

Willey, Helen H., interviewed by James R. Hansen. "When Computers Were Human." [n.d.], <https://www.youtube.com/watch?v=Dh-EHz3RtM8>, accessed January 19, 2017.

Workshop on Correlation of Hot Structures Test Data with Analysis, NASA CP 3065. Proceedings held at NASA Ames Research Center, Dryden Flight Research Facility, November 15-17, 1988. Edwards, CA: NASA Dryden Flight Research Facility, 1988. In Michael DeAngelis, "Outbriefing Spanning 7/1/65 to 1/3/01," slide 10. NASA Flight Loads Laboratory, Armstrong Flight Research Center.

X-1B Flight Log. 1958. File L3-10-1A-2, NASA Armstrong Historical Reference Collection.

X-1B Progress Reports, February 1 to February 28, 1957; March 1 to March 31, 1957, April 1 to April 30, 1957, June 1 to June 30, September 1 to September 30, 1957, November 1 to November 30, 1957, January 1, 1958 to January 31, 1958, and May 1 to May 31, 1958. File L1-3-11A-1, NASA Armstrong Historical Reference Collection.

X-1B [Maintenance/Configuration Control] Log Book, 1957, 1958. File L1-3-11A-2, NASA Armstrong Historical Reference Collection.

Secondary

A Reference Text Prepared by the Staffs of the Guggenheim Aeronautical Laboratory and the Jet Propulsion Laboratory, GALCIT. California Institute of Technology, for the Air Technical Service Command. Edited by Tsien, Hsue-shen, 1946.

Accident Aircraft Report: NASA 712, Convair 990, N712NA, March Air Force Base, July 17, 1985, Executive Summary. Washington, D.C.: NASA, 1986.

Abzug, Malcom J. and E. Eugene Larrabee. *Airplane Stability and Control, Second Edition: A History of the Technologies that Made Aviation Possible.* Cambridge Aerospace Series 14. Cambridge, UK: Cambridge University Press, 2002.

Ackeret, J. High-Speed Wind Tunnels: Paper presented at the Fifth Convention of the Volta Congress, Italy, September 30 to October 6, 1935. Translated by S. Reiss. NACA TM 808. Washington: 1936.

Adams, James J. and Robert Chilton. *A Weight Comparison of Several Attitude Controls for Satellites.* NASA Memo 12-30-58L. Langley, VA: Langley Research Center, 1959.

Aeronautics: Report of the Advisory Committee for Aeronautics for the Year 1909-1910. London: HMSO, 1910. In Alex Roland, *Model Research: The National Advisory Committee for Aeronautics, 1915-1958* Vol. 1 Washington, D.C.: NASA, 1985.

Aftosmis, Michael J. and Stuart E. Rogers. *Characterization of Space Shuttle Ascent Debris Aerodynamics Using CFD Methods.* AIAA 2005-1223. Presented at the 43rd AIAA Aerospace Sciences Meeting, Reno NV, January 10-13, 2005.

"Air Force Weather Duo Guides Space Shuttle Home." *Spaceflight Now.* November 19, 2000. <https://spaceflightnow.com/news/n0011/19ferry/>, accessed January 10, 2018.

Aviation. Vol. XII, No. 13 (March 27, 1922).

Allen, H. Julian and A. J. Eggers. *A Study of the Motion and Aerodynamic Heating of Ballistic Missiles Entering the Earth's Atmosphere at High Supersonic Speeds.* NACA Report 1381. Ames Aeronautical Laboratory Field, Moffett Field, Calif. April 1953.

- Aly-Hassan, Mohamed S. "A New Perspective in Multifunctional Composite Materials." In Klaus Friedrich and Ulf Breuer, eds. *Multifunctionality of Polymer Composites: Challenges and New Solutions*. Amsterdam: Elsevier, 2015.
- Annual*. Society of Experimental Test Pilots. n. a. 1957.
- Anderson, John D. "Research in Supersonic Flight and the Breaking of the Sound Barrier." In *From Engineering Science to Big Science: The NACA and NASA Collier Trophy Research Project Winners*. Edited by Pamela E. Mack. Washington, D.C.: NASA, 1998.
- Anderson, Raymond F. *Determination of the Characteristics of Tapered Wings*. Report No. 572. Langley, CA: NACA Langley Memorial Research Laboratory, 1937; republished in 1940.
- Armstrong, Johnny. "X-24B Concrete Runway Landing." In *Flight Testing at Edwards*. <http://www.johnnyarmstrong.com/test-stories/x-24b-concrete-runway-landing/>, accessed April 22, 2014.
- Arnold, H. H. "Air Force in the Atomic Age." In *One World or None*. Dexter Masters and Katharine Way, eds. New York: McGraw, Hill Co., Inc., 1946.
- Aviation* 12, No. 13 (March 27, 1922): 363.
- Aviation Safety Network*, <http://aviation-safety.net/database/record.php?id=19730412-1>, accessed September 7, 2011.
- Bapanapalli, Satish Kumar. "Design of an Integral Thermal Protection System for Future Space Vehicles." Ph.D. Diss. University of Florida, 2007.
- Barnes, C. H. *Shorts Aircraft Since 1900*. London: Putnam Aeronautical Books, 1967.
- Becker, John V. "Preliminary Studies of Manned Satellites: Winged Configurations." In *NACA Conference on High-Speed Aerodynamics. A Compilation of Papers Presented*. March 18, 19, and 20, 1958. Moffett Field, CA: NACA, Ames Aeronautical Laboratory, 1958.
- _____. *The High Speed Frontier: Case Histories of Four NACA Programs, 1920-1950*. Washington, D.C.: NASA, 1980.
- Berger, Peter L. and Thomas Luckmann. *The Social Construction of Reality: A Treatise in the Sociology of Knowledge*. Garden City, New York: Anchor Books, 1966.
- Berkner, Lloyd V. Address to the American Geophysical Society, January 20, 1959. In *The Next Ten Years in Space: 1959-1969*. Staff Report of the Select Committee on Astronautics and Space Exploration, 86th Congress, First Session, House Document No. 115. Washington, D.C.: U.S. Government Printing Office, 1959.
- Bloor, David. *The Enigma of the Aerofoil: Rival Theories in Aerodynamics, 1909-1930*. Chicago: The University of Chicago Press, 2011.
- Bodenschatz, Eberhard and Michael Eckert. *Prandtl and the Göttingen School*. <http://www.google.com/url?sa=t&rct=j&q=&esrc=s&source=web&cd=6&ved=0CEIQFjAF&url=http%3A%2F%2Farxivorg%2Fpdf%2F1107.4729&ei=4kedVaPhF4WXYgSOhKCwBg&usg=AFQjCNFIRAeNrSeQEUwhDxmHkEdJ52XUHg>, accessed July 8, 2015.
- Boggs, Bernard C. *The History of Static Test and Air Force Structures Testing*. TR AFFDL 79 3071. Dayton, OH: U.S. Air Force, 1979, http://www.oac.cdlib.org/findaid/ark:/13030/kt258010n1/entire_text/, accessed January 8, 2016.
- Bohn-Meyer, Marta and Fred Jiran. "Techniques for Modifying Airfoils and Fairings on Aircraft Using Foam and Fiberglass." 81-2445. Presented at the AIAA, SETP, SFTE, SAE, ITEA, and IEEE 1st Flight Test Conference, Las Vegas, Nevada, November 11-13, 1981.
- Böhrk, Hannah. *Transpiration Colling at Hypersonic Flight—AKTiV on SHEFEX II*. 11th Annual AIAA/ASME Joint Thermophysics and Heat Transfer Conference. paper 2676, Atlanta, GA, June 16-20, 2014.
- Bona, C. F. Italian High-Speed Airplane Engines. Paper presented at the Fifth Convention of the Volta Congress, Italy, September 30 to October 6, 1935. Translated by S. Reiss. NACA TM 944. Washington, 1940.

Boston Traveler. November 4, 1941.

Bowers, Albion H. and Oscar Murillo, Robert “Red” Jensen and Brian Eslinger, and Christian Gelzer. *On Wings of the Minimum Induced Drag: Spanload Implications for Aircraft and Birds*. NASA TP 2016-219072: <https://www.google.com/#q=On+Wings+of+the+Minimum+Induced+Drag:+Spanload+Implications+for+Aircraft+and+Birds%2C+NASA+TP+2016-219072>, accessed May 30, 2018.

Bray, Richard S., Fred J. Drinkwater III, and Maurice D. White. *A Flight Study of a Power-Off Landing Technique Applicable to Re-entry Vehicles*. NASA TN D-323. Moffett Field, CA: NASA Ames Research Center, 1960.

Breguet, Louis. “Aerodynamical Efficiency and the Reduction of Air Transport Costs.” *Aeronautical Journal* (August 1922): 307-320. Proceedings, Twelfth Meeting, 57th Session [Royal Aeronautical Society, Britain], in James R. Hansen, ed., *The Wind and Beyond: A Documentary Journey into the History of Aerodynamics in America*. Vol. 2. Washington, D.C.: NASA, 2007.

Bugos, Glenn E. *Atmosphere of Freedom: Sixty Years at the NASA Ames Research Center*. Washington, D.C.: NASA, 2000.

Busemann, A[dolph]. “Aerodynamischer Auftrieb bei Überschallgeschwindigkeit.” In *Convegno di Scienze Fisiche, Matematiche 3 Naturali: Le Alte Velocità in Aviazione, 30 Settembre – 6 Ottobre, 1935-XIII*. Roma: Reale Accademia D’Italia, 1936-XIV. NASA Armstrong Flight Research Center Research Library.

_____. “Aerodynamischer Auftrieb bei Überschallgeschwindigkeit.” *Luftfahrtforschung*. Bd. 12, Nr. 6, October 3, 1935.

Butrica, Andrew J. “Reusable Launch Vehicles or Expendable Launch Vehicles? A Perennial Debate.” Citing Goddard. “A New Turbine Rocket Plane for the Upper Atmosphere.” *Popular Science*. File 824 of the NASA Historical Reference Collection. NASA Headquarters, Washington, D.C. In Steven J. Dick and Roger D. Launius, eds., *Critical Issues in the History of Spaceflight*. Washington, D.C.: NASA, 2006.

Capasso, Vincent J., Jr.: “Space Shuttle Related Maintenance Experience with the X-15 Aircraft.” In *Proceedings of the Space Transportation System Technology Symposium*. Vol. 5. NASA TM X-52876. Cleveland, OH: Lewis Research Center, July 1970.

Carter, John F. and Christopher J. Nagy. *The NASA Landing Gear Test Airplane*. NASA TM 4703. Edwards, CA: NASA Dryden Flight Research Center, June 1995.

Chapline, Gail, Alvaro Rodriguez, Cooper Snapp, Myron Pessin, Paul Bauer, Bruce Steinezt, Charles Stevenson, and Charles Stevenson. “Thermal Protection System.” In *Wings in Orbit: Scientific and Engineering Legacies of the Space Shuttle*. ed. Helen Lane. (Washington, D.C.: NASA, 2001). https://www.nasa.gov/centers/johnson/pdf/584728main_Wings-ch4b-pgs182-199.pdf, accessed June 10, 2018.

Cohen, Robert S. and Thomas Schnelle. *Cognition and Fact: Ludwik Fleck, 1896-1961*. Dordrecht, Holland: Reidel Publishing Company, 1986.

Collins, Michael. *Liftoff: The Story of America’s Adventure in Space*. New York: Grove Press, 1988.

Columbia Accident Investigation Board Report. Vol. 1. Washington, D.C.: NASA, 2003.

Constant, II. Edward. *The Origins of the Turbojet Revolution*. Baltimore: Johns Hopkins University Press, 1980.

Corda, Stephen, Donald Whiteman, Ting Tseng, and Ricardo Machin. *The F-15B Lifting Insulting Foam Trajectory (LIFT) Flight Test*. NASA TM-2006-213674. Edwards, CA: NASA Dryden Flight Research Center, June 2006.

Corda, Stephen, Ting Tseng, Matthew Reeves, Kendall Mauldin, and Donald Whiteman. “Very High-Speed Digital Video Capability for In-Flight Use.” *NASA Tech Briefs*. February 2006.

Crossfield, A. Scott, and Clay Blair, Jr. *Always Another Dawn: The Story of a Rocket Test Pilot*. New York: Arno Press, 1972.

Curry, Donald M., John W. Latchem, and Garland B. Whisenhut. “Space Shuttle Orbiter Leading Edge

Structural Subsystem Development.” AIAA 21st Aerospace Sciences Meeting, January 10-13, 1983, Reno, NV. AIAA 83-0483.

Currey, Norman S. *Aircraft Landing Gear Design: Principles and Practices*. Washington, D.C.: American Institute of Aeronautics and Astronautics, 1998.

“CV-990 Shuttle Testbed Aircraft.” NASA AD88-580 [n.a., n.d.].

Dana, William H. and J. R. Gentry. “Pilot Impressions of Lifting Body Vehicles.” In *Flight Test Results Pertaining to the Space Shuttlecraft*. NASA TM-X-2010. Edwards, CA: NASA Flight Research Center, 1970.

Daso, Dik. *Architects of American Air Supremacy: General Hap Arnold and Dr. Theodore von Karman*. Ph.D. Diss., University of South Carolina, 1996.

Daugherty, Robert H. and Thomas J. Yager. *Texture Modification of the Shuttle Landing Facility Runway at the Kennedy Space Center*. Langley, VA: Langley Research Center, May 1997.

Daugherty, Robert H., Thomas J. Yager, and Sandy Stubbs. *Shuttle Landing Runway Modification to Improve Tire Spin-Up Wear Performance*. SAE Technical Paper Series, 881402, October 1988.

Davis, Noah S., Jr. and John H. Keefe. “Concentrated Hydrogen Peroxide as a Propellant.” *Industrial & Engineering Chemistry* 1956, 48 (4): 745-748. <http://pubs.acs.org/doi/abs/10.1021/ie50556a025>, accessed September 23, 2014.

Day, Richard E. *Coupling Dynamics in Aircraft: A Historical Perspective*. Edwards, CA: NASA Dryden Flight Research Center, 1997.

“DFRC Orbiter Landing Investigation Team Final Presentation.” [n.a.] August 1978. File Folder L1-5-7-22, Milton O. Thompson Collection, NASA AFRC Historical Reference Collection.

Divine, Robert A. *The Sputnik Challenge: Eisenhower’s Response to the Soviet Satellite*. New York: Oxford University Press, 1993.

Doenhoff, Albert E. von, and George W. Jones Jr. *An Analysis of the Power-Off Landing Maneuver in Terms of the Capabilities of the Pilot and the Aerodynamic Characteristics of an Airplane*, NACA TN 2967. Langley, VA: Langley Aeronautical Laboratory, 1953.

Douglas Aircraft Company Technical Report on High Altitude and High Speed. Report Number E.S. 17673. [n.a.] El Segundo: Douglas Aircraft Co, Inc., 1954.

Drake, Hubert M. *Energy Management Requirements of Entry Vehicles*. NASA Conference on Review of NASA Research Related to Control Guidance and Navigation of Space Vehicles. Moffett Field, CA: NASA Ames Research Center, February 25 27, 1959.

_____. “Flight Experience with Present Research Airplanes.” In *Research Airplane Committee Report on Conference on the Progress of the X-15 Project: A Compilation of Papers Presented*. Langley, VA: NACA, October 25-26, 1956.

Drake, Hubert M., Donald R. Bellman, and Joseph A. Walker. Hubert M. Drake, Donald R. Bellman, and Joseph A. Walker, *Operational Problems of Manned Orbital Vehicles*, NACA RM H58D21, (Edwards, CA: NACA High-Speed Flight Station, 1958) p. 2-3. <http://naca.central.cranfield.ac.uk/reports/1958/naca-rm-h58d21.pdf>, accessed June 22, 2016.

_____. “Operational Problems of Manned Orbital Vehicles.” In *NACA Conference on High-Speed Aerodynamics. A Compilation of Papers Presented*. March 18, 19, and 20, 1958. Moffett Field, CA: NACA, Ames Aeronautical Laboratory, 1958.

Drake, Hubert M. and Wendell H. Stillwell. *Behavior of the Bell X-1A Research Airplane During Exploratory Flights at Mach Numbers Near 2.0 and at Extreme Altitudes*. NACA RM H55G25. Edwards, CA: NACA High Speed Flight Station, 1955.

Drinkwater, Fred J. III and George E. Cooper. *A Flight Evaluation of the Factors Which Influence the Selection of Landing Speeds*. NASA Memo 10-6-58A. Ames Research Center, 1958.

Drinkwater, Fred J. III, Maj. Clark Price, and James M. Patton, Jr. “Research Pilots’ Observations of Aircraft

Performance on a Grooved Runway.” *Pavement Grooving and Traction Studies*. Washington, D.C.: NASA, 1969.

Dryden, Hugh L. “NACA: What it’s Doing and Where it’s Going.” *Missiles and Rockets I* (October 1956).

Dukes, Wilfred and A. Schnitt, “An Introduction to Structural Design for Aerodynamic Heating,” WADC Technical Report 55-305 Pt. II. In Robert Godwin, ed., *Dyna-Soar: Hypersonic Strategic Weapons System*. Burlington, Ont., Can.: Apogee Book Series, 2003.

Duncan, Francis. *Rickover and the Nuclear Navy: The Discipline of Technology*. Annapolis, MD: Naval Institute Press, 1990.

Eckert, Michael. *Dawn of Fluid Dynamics: A Discipline Between Science and Technology*. Berlin: Wiley-VCH; 1, 2006.

_____. *Ludwig Prandtl: Strömungsforscher und Wissenschaftsmanager, ein unverstellter Blick auf sein Leben*. Berlin: Springer-Verlag, 2017.

Edwards, Frederick G. and John D. Foster. *Flight Test Results from the CV-990 Simulated Space Shuttle During Unpowered Automatic Approaches and Landings*. NASA TM X-62,285. Moffett Field, CA: NASA Ames Research Center, 1973.

Eggers, Alfred J., Jr., H. Julian Allen, and Stanford E. Neice. “A Comparative Analysis of the Performance of Long-Range Hypervelocity Vehicles.” Report 1382. In *NACA 44th Annual Report of the National Advisory Committee for Aeronautics 1958 Report*. Washington, D.C.: NASA, 1958.

Eppley, Charles V. *The Rocket Research Aircraft Program, 1946-1962*. Technical Document Report No. 63-3. Edwards, CA: U.S. Air Force Flight Test Center, 1963.

Ezell, Linda Neuman. *NASA Historical Data Book, Vol. II: Programs and Projects, 1958-1968*. Washington, D.C.: NASA, 1988.

Faget, Maxime A., Benjamin J. Garland, and James J. Buglia. “Preliminary Studies of Manned Satellites—Wingless Configuration: Nonlifting.” In *NACA Conference on High-Speed Aerodynamics. A Compilation of Papers Presented*. March 18, 19, and 20, 1958. Moffett Field, CA: NACA, Ames Aeronautical Laboratory, 1958.

Federal Aviation Administration. *FAR/AIM Federal Aviation Regulations/Aeronautical Information Manual 2013*. New York, N.Y.: Skyhorse Publishing, 2012.

Feltz, Charles H. “Description of the X-15 Airplane, Performance, and Design Mission.” In *Research Airplane Committee Report on Conference on the Progress of the X-15 Project: A Compilation of Papers Presented*. Langley, VA: NACA: October 25-26, 1956.

Ferguson, Robert G. *NASA’s First A: Aeronautics from 1958-2008*. Washington, D.C.: NASA, 2013.

Ferrari, Carlo. “Recalling the Vth Volta Congress: High Speeds in Aviation.” *Annual Review of Fluid Mechanics* 28, 1996: 1-9.

“Fiber Optic Sensing,” <https://www.nasa.gov/feature/fiber-optic-sensing>, accessed May 28, 2016.

Fields, Roger A. “Flight Vehicle Thermal Testing with Infrared Lamps.” Presented at the Structural Testing Technology at High Temperature Conference. Dayton, OH, November 4 6, 1991.

Fields, Roger A., Lawrence F. Reardon, and William H. Siegel. *Loading Tests of a Wing Structure for a Hypersonic Aircraft*. NASA TP-1596. Edwards, CA: NASA Dryden Flight Research Center, 1980.

Fleck, Ludwik. *Genesis and Development of a Scientific Fact*. Edited by Thaddeus J. Trenn and Robert K. Merton, translated by Fred Bradley and Thaddeus J. Trenn, Foreword by Thomas S. Kuhn. Chicago, IL: University of Chicago Press, 1979, paperback 1981; Benno Schwabe & Co., Basel, Switzerland, 1935.

Flight Experience with Two High-Speed Airplanes Having Violent Lateral-Longitudinal Coupling in Aileron Rolls. [n.a.] NACA RM H55A13. Edwards, CA: NACA High-Speed Flight Station, 1955.

Flight Test Results Pertaining to the Space Shuttlecraft. NASA TM-X-2010. Edwards, CA: NASA Flight Research Center, 1970.

- Garrison, Peter. "Why Are Wings Swept?" *Flying* January 23, 2009. <http://www.flyingmag.com/why-are-wings-swept>, accessed January 30, 2017.
- Gelzer, Christian. *Fairing Well, From Shoebox to Bat Truck and Beyond: Aerodynamic Truck Research at NASA's Dryden Flight Research Center*. Washington, D.C.: NASA, 2011.
- _____. *The Spoken Word III: Recollections of Dryden History, the Shuttle Years*. Editor. NASA SP 4552. Edwards, CA: NASA Dryden Flight Research Center, 2013.
- _____. "The Quest for Speed: An American Virtue, 1825-1930." PhD diss. Auburn University, 1998.
- Glanz, James and Edward Wong. "Engineer's '97 Report Warned of Damage to Tiles by Foam." *New York Times* February 4, 2003, <http://www.nytimes.com/2003/02/04/national/04WRON.html?pagewanted=all>, accessed May 30, 2018.
- Goddard, Robert H. *Rocket Development: Liquid-Fuel Rocket Research, 1929-1941*. Edited by Esther C Goddard and G. Edward Pendray. NY: Prentice-Hall, Inc., 1948.
- _____. "Liquid-Propellant Rocket Development." In *Rockets*. Reston, VA: American Institute of Aeronautics and Astronautics, 1946, 2002.
- Gong, Leslie, Robert D. Quinn, and William L. Ko. *Reentry Heating Analysis of Space Shuttle with Comparison of Flight Data*. In *Computational Aspects of Heat Transfer in Structures*. Langley, VA: NASA Langley Research Center, 1982.
- Gorn, Michael H. *Expanding the Envelope: Flight Research at NACA and NASA*. Lexington, KY: The University Press of Kentucky, 2001.
- _____. *Hugh L. Dryden: A Career in Aviation and Space*. Washington, D.C.: NASA, 1996.
- _____. Editor. *Prophecy Fulfilled: "Toward New Horizons and Its Legacy."* Dayton, OH: Air Force History and Museums Program, 1994.
- _____. "The NACA and its Military Patrons in the Supersonic Era, 1940-1958." *Air Power History* Fall 2011: 16-27.
- Gothert, B. *Hochgeschwindigkeitmessungen an einem Pfeilflugel*. Report 156. Lilienthal-Gesellschaft für Luftfahrtforschung, [1944?]. Published as NACA No. 1102. *High-Speed Measurements on a Sweptback Wing*. Translated by Dean R. Chapman. Washington, D.C.: NACA, 1947.
- Graham, Loren, R. *The Ghost of the Executed Engineer: Technology and the Fall of the Soviet Union*. Cambridge, MA: Harvard University Press, 1993.
- H₂O₂ Field Handling and Storage of 90% Hydrogen Peroxide*. Denville, NJ: Reaction Motors, Inc., n.d.
- Hallion, Richard P. "Gluhareff, Jones, and Lippisch: The Emergence of the Delta Planform and the Origins of the Swept Wing in the United States." Undated paper containing elements of an interview with R. T. Jones. NASA AFRC Reference Collection.
- _____. "Sweep and Swing: Reshaping the Wing for the Jet and Rocket Age." In *NASA's Contributions to Aeronautics, Vol. I: Aerodynamics, Structures, Propulsion, Control*. Richard P. Hallion, ed. Washington, D.C.: NASA, 2010.
- _____. *Test Pilots: The Frontiersmen of Flight*. Washington, D.C.: Smithsonian Institution Press, 1981, revised 1988.
- Hallion, Richard P., and Michael H. Gorn. *On the Frontier: Experimental Flight at NASA Dryden*. 2nd ed. Washington, D.C.: Smithsonian Books, 2003.
- Hansen, James R. *Engineer in Charge: A History of the Langley Aeronautical Laboratory, 1917-1958*. Washington, D.C.: NASA, 1987.
- _____. *The Bird is on the Wing: Aerodynamics and the Progress of the American Airplane*. College Station, TX: Texas A&M University Press, 2004.
- _____. *The Wind and Beyond: A Documentary Journey into the History of Aerodynamics in America*. Vol.

2. Washington, D.C.: NASA, 2007.

Harwood, Jonathan. "Ludwik Fleck and the Sociology of Knowledge." *Social Studies of Science* (SAGE) Vol. 16 (1986): 173-187.

Heppenheimer, T. A. *The Space Shuttle Decision: NASA's Search for a Reusable Space Vehicle*. Washington, D.C.: SP-4221, 1999.

Hirschel, Ernst Heinrich, Horst Prem and Gero Madelung. *Aeronautical Research in Germany: From Lilienthal Until Today*. Heidelberg, Ger.: Springer-Verlag, 2004.

Hoag, Peter C. and B. Lyle Schofield. "IFR Experience with Unpowered, Low-Lift-to-Drag Ratio Handling Approaches." In *Flight Test Results Pertaining to the Space Shuttlecraft*. NASA TM-X-2101. Edwards, CA: NASA Flight Research Center, 1970.

Hoey, Robert G. and Richard E. Day. "X-15 Mission Planning and Operational Procedures." In *Research-Airplane Committee Report Conference on the Progress of the X-15 Project. A Compilation of Papers Presented*. Langley, VA: NACA Langley Aeronautical Laboratory, 1961.

Hoey, Robert G., et al. "AFFTC Evaluation of the Space Shuttle Orbiter and Carrier Aircraft – NASA Approach and Landing Test." AFFTC-TR-78-14. Office of Advanced Manned Vehicles. Edwards, CA, May 1978.

Hohmann, Walter. *The Attainability of Heavenly Bodies*. NASA TT F-44. Washington, D.C.: NASA, 1960; Munich: R. Oldenbourg, 1925.

Holleman, Euclid C. and Elmor J. Adkins. "Contributions of the X-15 Program to Lifting Entry Technology." *Journal of Aircraft* Vol. 1, No. 6, November-December 1964.

Holleman, Euclid C. and Wendell Stillwell. "Simulator Investigation of Command Reaction Controls." In *NACA Conference on High-Speed Aerodynamics. A Compilation of Papers Presented*. March 18, 19, and 20, 1958. Moffett Field, CA: NACA, Ames Aeronautical Laboratory, 1958.

Hotz, Robert. "New Tunnel Throat Aids Transonic Study." *Aviation Week* 25, Vol. 50 (June 20, 1949): 12-13.

Houchin, Roy Franklin, II. "The Rise and Fall of Dyna-Soar: A History of Air Force Hypersonic R&D, 1944-1963." Ph.D. Diss. Auburn University, 1995.

http://contrailscience.com/wp-content/uploads/nkc-135-icing-attachmentpv1983_2688.pdf, accessed June 7, 2018.

<http://ed-thelen.org/comp-hist/vs-mit-apollo-guidance.html>, accessed March 15, 2012.

<https://launiusr.wordpress.com/2016/05/06/john-j-ide-the-nacas-spy-in-pre-wwii-europe/>, accessed March 31, 2017.

<https://metinmediamath.wordpress.com/2013/12/01/space-shuttle-launch-and-sound-suppression/>, accessed November 3, 2016.

<https://ntrs.nasa.gov/search.jsp?R=20160003578>, accessed March 15, 2017.

<http://pubs.acs.org/doi/abs/10.1021/ie50556a025>, accessed September 23, 2014.

http://science.ksc.nasa.gov/shuttle/technology/sts-newsref/sts_mes.html#mes_entry, accessed June 10, 2015.

<https://spaceflight.nasa.gov/shuttle/reference/shutref/orbiter/tps/carbon.html>, accessed January 2, 2018.

<http://www.af.mil/information/factsheets/factsheet.asp?id=99>, accessed December 16, 2011.

<http://www.colorado.edu/Sociology/gimenez/soc.5001/durk1.html>, accessed April 24, 2017.

<http://www.cowardstereoview.com/analog/good.htm>, accessed August 4, 2014.

<http://www.dailymotion.com/video/x54r7ka>, accessed May 16, 2018.

<http://www.designation-systems.net/usmilav/aircraft.html>, accessed September 22, 2018, accessed September 23, 2018.

<http://www.designation-systems.net/usmilav/aircraft.html>, accessed Aug. 14, 2018.

http://www.dlr.de/100Jahre/en/desktopdefault.aspx/tabid-2565/4432_read-21499/, accessed March 21, 2017.

<http://www.edwards.af.mil/News/Article/396358/nasa-edwards-practice-for-future-shuttle-landings/>, accessed June 7, 2018.

<http://www.edwards.af.mil/news/story.asp?id=123099491>, accessed December 7, 2011.

<http://www.espritmodel.com/explanation-of-the-d-box-build-technology.aspx>, accessed January 30, 2017.

<http://www.mdguidelines.com/toxic-effects-beryllium>, accessed May 10, 2012.

<http://www.military.com/military-report/air-reserve-individual-mobilization-augmentees.html>, accessed March 27, 2017.

<http://www.nas.edu/history/igy/>, accessed December 2, 2014.

<https://www.nasa.gov/centers/ames/orgs/exploration-tech/range-complex.html#.Vb-x7UXVbFk>, accessed August 3, 2015.

https://www.nasa.gov/centers/armstrong/features/mars_airplane.html, accessed March 15, 2017.

<https://www.nasa.gov/centers/armstrong/news/FactSheets/FS-104-DFRC.html>, accessed May 28, 2016.

http://www.nasa.gov/centers/armstrong/news/X-Press/hiad_06_14.html, accessed May 28, 2016.

http://www.nasa.gov/mission_pages/shuttle/launch/landing101.html, accessed June 10, 2015.

https://www.rand.org/pubs/special_memoranda/SM11827.html, accessed January 11, 2018.

http://www.slate.com/articles/news_and_politics/explainer/2004/09/where_does_space_begin.html, accessed Aug. 14, 2018.

<http://www.space.com/33906-nasa-mars-airplane-prandtl-test-flight-photos.html>, accessed March 15, 2017.

<http://www.spacelaunchreport.com/falcon9.html>, accessed October 20, 2016.

http://www.spacemart.com/reports/Swept_Wings_The_Breakthrough_To_Modern_Aviation_999.html, accessed July 17, 2017.

Hudson, Larry D. and Randolph C. Thompson. *Single-Strain-Gage Force/Stiffness Buckling Prediction Techniques on a Hat-Stiffened Panel*. NASA TM 101733. Edwards, CA: NASA Dryden Flight Research Center, 1991.

Hunsaker, Jerome C. "Europe's Facilities for Aeronautical Research." n.p., n.d. In Alex Roland, *Model Research*, Vol. 1.

Hurwitz, Frances I. *Thermal Protection Systems (TPSs)*. https://www.researchgate.net/publication/230293975_Thermal_Protection_Systems_TPSs, accessed November 28, 2016.

Jacobs, Eastman. Methods Employed in America for the Experimental Investigation of Aerodynamic Phenomena at High Speeds. NACA TN 715, 1939. In *Convegno di Scienze Fisiche, Matematiche Naturali: Le Alte Velocita in Aviazione*, 30 Settembre – 6 Ottobre, 1935-XIII. Roma: Reale Accademia D'Italia, 1936-XIV.

Jackson, A. J. *British Civil Aircraft Since 1919*. Vol. 3. London: Putnam, 1974.

Jake Garn Mission Simulator and Training Facility, Building 5: Historical Documentation. Houston, TX: NASA Johnson Space Center, 2010.

Jarvis, Calvin R. and Wilton P. Lock. *Operational Experience with the X-15 Reaction Control and Reaction Augmentation Systems*. NASA TN D-2864. Edwards, CA. NASA Flight Research Center, 1965.

Jenkins, Dennis, R. *Space Shuttle: Developing an Icon—1972-2013, Vol. 1: Setting the Stage*. Cape Canaveral, FL: Dennis R. Jenkins, 2016.

_____. *Space Shuttle: Developing an Icon—1972-2013, Vol. 2: Technical Description*. Cape Canaveral, FL: Dennis R. Jenkins, 2016.

_____. *Space Shuttle: Developing an Icon—1972-2013, Vol. 3: The Flight Campaign*. Cape Canaveral, FL: Dennis R. Jenkins, 2016.

_____. *Space Shuttle: The History of the National Space Transportation System: The First 100 Missions*. 3rd ed. Cape Canaveral, FL: Dennis R. Jenkins, 2002.

_____. *The X-15: Extending the Frontiers of Flight*. Washington, DC: NASA, 2007.

Jenkins, Dennis R. and Tony R. Landis. *Experimental & Prototype U.S. Air Force Jet Fighters*. Cape Canaveral, FL: Dennis R. Jenkins, 2008.

Johnson, Clarence L. "Investigation of Tail Buffeting Conditions on Lockheed P-38 Airplane." Lockheed Report No. 2414, September 23, 1941. In James R. Hansen, *Engineer in Charge: A History of the Langley Aeronautical Laboratory, 1917-1958*. Washington, D.C.: NASA, 1987.

Jones, Daniel S. *The Orion Pad Abort 1 (PA-1) Flight Test: A Propulsion Success*. TN-18252. Edwards, CA: NASAS Armstrong Flight Research Center, 2015.

Jones, Daniel S., Joseph H. Ruf, and Trong T. Bui. *Conceptual Design for a Dual-Bell Rocket Nozzle System Using a NASA F-15 Airplane as the Flight Test Bed*. TM-2014-218376. Edwards, CA: Armstrong Flight Research Center, 2014.

Jones, Robert T., compiler. *Classical Aerodynamic Theory*. NASA Reference Publication 1050. Moffett Field, CA: Ames Research Center, 1979.

_____. "My Adventures in Aeronautics." Department of Special Collections, Stanford University Libraries, box 11, folder 11. In Bruce I. Larimer, *Thinking Obliquely: Robert T. Jones, the Oblique Wing, NASA's AD-1 Demonstrator, and its Legacy*. Washington, D.C: NASA, 2011.

_____. *Properties of Low-Aspect Ratio Pointed Wings at Speeds Below and Above the Speed of Sound*. NACA TN 1032. Originally published as Report No. 835. Langley, VA. NACA Langley Memorial Aeronautical Laboratory, 1945.

_____. *Wing Plan Form for High-Speed Flight*. In *Collected Works of Robert T. Jones*. NASA TM X-3334. Moffett Field, CA: NASA Ames Research Center, 1976. Originally published as Report No. 863. Langley, VA. NACA Langley Memorial Aeronautical Laboratory, 1945.

_____. "Recollections from an Earlier Period in American Aeronautics." *Annual Review of Fluid Mechanics* (1977): pp. 1-11.

Kármán, Theodore von. *Aerodynamics*. New York: McGraw-Hill Book Company, Inc., 1963. In *NASA's Contributions to Aeronautics, Vol. 1: Aerodynamics, Structures, Propulsion, Control*. Richard P. Hallion, ed. Washington, D.C.: NASA, 2010.

_____. "Aerodynamic Heating: The Temperature Barrier in Aeronautics." In *David K. Stumpf, Titan II: a History of a Cold War Missile Program*. Foreword by Lt. Gen. Jay W. Kelley, Ret. *High Temperature Symposium*. June 25-27, 1956, University of California Berkeley. Fayetteville: University of Arkansas Press, 2000.

_____. *Die Wirbelstrasse, mein Leben für die Luftart*. Hoffman und Kampe Verlag, 1968, cited in Hans-Ulrich Meier, et al, *German Development of the Swept Wing, 1935-1945*, translated by Egon Stanewsky. Reston, VA: AIAA, 2010.

_____. *The Problem of Resistance in Compressible Fluids*. GALCIT Pub. No. 75, 1936. From R. Accad. D'Italia cl. di sci. fis., mate. nat., Vol. XIV, 1936. In *R. T. Jones. NACA Report No. 863. Wing Plan Form for High-Speed Flight*.

_____. *Toward New Horizons: Science the Key to Air Supremacy. A Report to General of the Army H. H. Arnold*. Submitted on Behalf of the AAF Scientific Advisory Group by Theodore von Kármán. Wright Field, Dayton OH: Headquarters Air Materiel Command, 1946.

_____. *Where We Stand, First Report to General of the Army H. H. Arnold on Long Range Research Problems of the AIR FORCES with a Review of German Plans and Developments*. Submitted on Behalf of the AAF Scientific Advisory Group by Theodore von Kármán. Wright Field, Dayton OH: Headquarters Air Materiel Command, 1945.

Kempel, Robert W., Weneth D. Painter, and Milton O. Thompson. *Developing and Flight Testing the HL-10*

- Lifting Body: A Precursor to the Space Shuttle*. Washington, D.C: NASA, 1994.
- Killen, Rosemary. Shuttle Program ALT Space Shuttle Program Barometric Altimeter Altitude Analysis. NASA TM 7952. Houston, TX: NASA Johnson Space Center, 1978.
- Ko, William L, Robert D. Quinn, and Leslie Gong. *Effects of Internal Convection and Internal Radiation on the Structural Temperatures of Space Shuttle Orbiter*. NASA TM 100414. Edwards, CA: NASA Dryden Flight Research Facility, 1988.
- Ko, William L. *Impacts of Space Shuttle Thermal Protection System Tile on an F-15 Aircraft Vertical Tail*. NASA TM 85904. Edwards, CA: Dryden Flight Research Facility, 1985.
- _____. *Open-Mode Debonding Analysis of Curved Sandwich Panels Subjected to Heating and Cryogenic Cooling on Opposite Faces*. NASA-TP-1999-206580. Edwards, CA: NASA Dryden Flight Research Center, 1999.
- Kock, Berwin M. and Fitzhugh L. Fulton, Jr. *Approach and Landing Studies*. NASA TM X-2101. Edwards, CA: NASA Flight Research Center, 1970.
- Kock, Berwin, M., Fitzhugh L. Fulton, Jr., and Fred J. Drinkwater III. *Low-Lift-To-Drag-Ratio Approach and Landing Studies Using a CV-990 Airplane*. NASA TN D-6732. Edwards, CA: NASA Flight Research Center, March 1972.
- Kuhn, Thomas. *The Structure of Scientific Revolutions*. Chicago: The University of Chicago, 1962; 4th edition, 2012.
- Launius, Roger D., and Dennis R. Jenkins. *Coming Home: Reentry and Recovery from Space*. Washington, D.C.: NASA, 2011.
- _____. John Jay Ide. <https://launiusr.wordpress.com/2016/05/06/john-j-ide-the-nacas-spy-in-pre-wwii-europe/>, accessed March 31, 2017.
- _____. “Recalling the Great NACA Fact-Finding Trip to Germany in 1936, and its Results.” September 12, 2016. <https://launiusr.wordpress.com/2016/09/12/the-great-naca-fact-finding-trip-to-europe-in-1936-and-its-results/>, accessed June 20, 2018.
- Larimer, Bruce I. *Thinking Obliquely: Robert T. Jones, the Oblique Wing, NASA’s AD-1 Demonstrator, and its Legacy*. Washington, D.C: NASA, 2011.
- Larsen, Curtis E. *Experience with Pogo in Human Spaceflight Vehicles*. NASA Johnson Space Center. <https://ntrs.nasa.gov/archive/nasa/casi.ntrs.nasa.gov/20080018689.pdf>, accessed November 7, 2016.
- Latour, Bruno. *Science in Action: How to Follow Scientists and Engineers Through Society*. Cambridge: Harvard University Press, 1987.
- Layton, Jr. G. P. “Summary of Primary Results of the Lifting Body Program.” In *Flight Test Results Pertaining to Space Shuttlecraft*. NASA TM X-2101. Edwards, CA: NASA Flight Research Center, 1970.
- Levine, Jay. “Joe Engle: ‘Rocket Man.’” *Dryden X-Press* Vol. 54, No. 9 August 3, 2012.
- _____. “Fiber Optic Sensors: Parker’s Algorithm Shatters a Technology Barrier.” *Dryden X-Press Aerovations*. August 5, 2011.
- _____. “SLS System Evaluated.” *Dryden X-Press*, Vol. 55, No. 9, November 2013.
- Love, James E. and Wendell H. Stillwell. *The Hydrogen-Peroxide Rocket Reaction-Control System for the X-1B Research Airplane*. NASA TN D-185. Edwards, CA: NASA Flight Research Center, 1959.
- “Space Shuttle High-Temperature Reusable Surface Insulation.” HRSI Fact Sheet. Lockheed Missile & Space Company, 1982.
- Ludwig, Pfeilflügel bei hohen Geschwindigkeiten (Versuchsergebnisse). In: Bericht 127 der Lilienthal-Gesellschaft für Luftfahrtforschung über die Sitzung “Hochgeschwindigkeit” am Braunschweig, September 26-27, 1940, http://www.aviation.tu-darmstadt.de/media/arbeitskreis_luftverkehr/downloads_6/kolloquien/9kolloquium/heinzerlingflgelpfeilungundflchenregel.pdf, accessed Aug. 14, 2018.

- Luskin, H. "The Problem of Descent and Landing." *Preliminary Design of an Experimental World-Circling Spaceship*. Report No. SM-11827. Santa Monica, CA: RAND Corporation: Douglas Aircraft Company, 1946.
- Manned Spaceflight Program of the National Aeronautics and Space Administration: Projects Mercury, Gemini, and Apollo*. Staff Report of the Committee on Aeronautical and Space Sciences, United States Senate, September 4, 1962. Washington, D.C.: U.S. Government Printing Office 1962.
- Mannheim, Karl. *Essays on the Sociology of Knowledge*. Edited by Paul Kecskemeti. London: Routledge & Kegan Paul, Ltd., 1952; first published as six essays between 1923 and 1929.
- Manke, John A., and Michael V. Love. "X-24B Flight Test Program." *SETP Technical Review Society of Experimental Test Pilots*, Lancaster, CA, Vol. 12, No. 4, September 1975.
- Martin, James A. "The Record-Setting Research Airplanes." *Aerospace Engineering* 21, 12 (Dec. 1962): 49-54.
- Masters, Dexter and Katharine Way, eds. *One World or None*. New York: McGraw, Hill Co., Inc., 1946.
- Matranga, Gene J., C. Wayne Ottinger, Calvin R. Jarvis with D. Christian Gelzer. *Unconventional, Contrary and Ugly: The Lunar Landing Research Vehicle*. Washington, D.C: NASA, 2006.
- Matranga, Gene J. *Analysis of X-15 Landing Approach and Flare Characteristics Determined from the First 30 Flights*. NASA TN D-1057. Edwards, CA: NASA Flight Research Center, 1961.
- Matranga, Gene J. and Neil A. Armstrong. *Approach and Landing Investigation at Lift-Drag Ratios of 3 to 4 Utilizing a Delta-Wing Interceptor Airplane*. NASA TM X-31. Edwards, CA: NASA Flight Research Center, 1960.
- Matranga, Gene J. and Joseph A. Menard. *Approach and Landing Investigation at Lift-Drag Ratios of 2 to 4 Utilizing a Straight-Wing Fighter Airplane*. NASA TN-D-323. Edwards, CA: NASA Flight Research Center, 1959.
- McTigue, John C. "Background and Current Status of the Lifting Body Program." In *Flight Test Results Pertaining to the Space Shuttlecraft*. NASA TM-X-2101. Edwards, CA: NASA Flight Research Center, 1970.
- Merlin, Peter. "50th Anniversary of Two Historic X-2 Milestones Celebrated." <http://www.nasa.gov/centers/dryden/news/NewsReleases/2006/06-34.html>, accessed January 19, 2012.
- Meyer, Robert R., Jr. *A Unique Flight Test Facility: Description and Results*. NASA TM 84900. Edwards, CA: NASA Ames-Dryden Flight Research Facility, 1982.
- Meyer, Robert R., Jr. Calvin R. Jarvis, and Jack Barneburg. *In-Flight Aerodynamic Load Testing of the Shuttle Thermal Protection System*. AIAA-81-2468. November 11, 1981.
- Meyer, Robert R., Jr. and Jack Barneburg. *In-Flight Rain Damage Tests of the Shuttle Thermal Protection System*. NASA TM 100438. Edwards, CA: Ames-Dryden Flight Research Facility. 1988.
- Michalopoulos, C. D. and David A. Hamilton. *Orbiter Tire Traction and Wear*. SAE Technical Paper Series, 95201. September 1995.
- Miller, Jay. *The X-Planes: X-1 to X-45*. 3rd ed. Hinckley, England: Midlands Publishing, 2001.
- Montoya, Lawrence C., and David P. Lux. *Comparisons of Wing Pressure Distribution from Flight Tests of Flush and External Orifices for Mach Numbers from 0.50 to 0.97*. NASA TM X-56032. Edwards, CA: NASA Flight Research Center, 1975.
- Moes, Timothy R. and Robert R., Jr. Meyer. *In-Flight Investigation of Shuttle Tile Pressure Orifice Installations*. TM-4219. Edwards, CA: NASA Dryden Flight Research Center, 1990.
- Multhopp, H[ans]. *Zur Aerodynamik des Flugzuerumpfes*. *Luftfahrtforschung*. Bd. 18, Lfg, 2/3, 29 March 1941. In Robert T. Jones, *Notes on the Stability and Control of Tailless Airplanes*. NACA TN 837. Langley Memorial Aeronautical Laboratory, NACA Langley Field, 1941.
- Munk, Max. *Note on the Relative Effect of the Dihedral and the Sweep Back of Airplane Wings*. NACA TN No. 177. Washington, D.C.: National Advisory Committee for Aeronautics, 1924.

- Murman, Scott M., Michael J. Aftosmis, and Stuart E. Rogers. *Characterization of Space Shuttle Ascent Debris Aerodynamics Using CFD Methods*. Presented at the 43rd AIAA Aerospace Sciences Meeting, January 10-13, 2005.
- Naughton, John “Thomas Kuhn: The Man Who Changed the Way the World Looked at Science.” *History of Science The Observer*, Saturday, August 18, 2012, <https://www.theguardian.com/science/2012/aug/19/thomas-kuhn-structure-scientific-revolutions>, accessed February 1, 2017.
- NASA/ESA CV-990 Spacelab Simulation (ASSESS II)*. A Joint Endeavor by the National Aeronautics and Space Administration and the European Space Agency, July 1977.
- NASA Fact Sheet FS-2004-08-97-MSFC, August 2004.
- “National Advisory Committee for Aeronautics.” *Aircraft Journal* Vol. 4, No. 26 (June 28, 1919).
- Neufeld, Jacob, George M. Watson, Jr., and David Chenoweth, eds. *Technology and the Air Force: A Retrospective*. Washington, D.C.: U.S. Air Force, 1997.
- O’Malley, Robert E. “Ludwig Prandtl’s Boundary Layer Theory.” in O’Malley, *Historical Developments in Singular Perturbations*. Heidelberg, Gr: Springer, 2014.
- Peebles, Curtis. *Probing the Sky: Selected NACA Research Airplanes and Their Contributions to Flight*. With contributions by Richard P. Hallion. Washington, D.C.: NASA, 2014, https://www.nasa.gov/connect/ebooks/aeronautics_ebooks_archive_1.html, accessed May 30, 2018.
- _____. “Risk Management in the X-Planes Era: D-558-II vs. X-1A at Mach 2.” *Quest* Vol. 11, No. 4 2004.
- _____. *Road to Mach 10: Lessons Learned from the X-43A Flight Research Program*. Reston Virginia: American Institute of Aeronautics and Astronautics, 2008.
- _____. “Then and Now: Flight Research in the Second Half of the 20th Century.” *SAFE Journal* Vol. 34, No. 1 Fall 2006: 34-44.
- Pelt, Michael van. *Rocketing into the Future: The History and Technology of Rocket Planes*. New York: Springer Praxis, 2012.
- Perkins, Courtland D. “Development of Airplane Stability and Control Technology.” 1970 Von Kármán Lecture. AIAA 6th Annual Meeting and Technical Display, Anaheim, Calif., October 20-24, 1969, 69-1137. *Journal of Aircraft* Vol. 7, No. 4 (July-August 1970): 290-301.
- Phillips, William H. *Effects of Steady Rolling on Longitudinal and Directional Stability*. NACA TN-1627. Langley, VA: Langley Memorial Laboratory, June 1948.
- Pinch, Trevor J. and Wiebe E. Bijker. “The Social Construction of Facts and Artefacts: Or How the Sociology of Science and the Sociology of Technology Might Benefit Each Other.” *Social Studies of Science*, Vol. 14, No. 3, August 1984.
- Piszkiewicz, Dennis. *The Nazi Rocketeers: Dreams of Space and War Crimes*. Mechanicsburg, PA: Stackpole Books, 1995.
- Powers, B. G. “Low-Speed Longitudinal Orbiter Flying Qualities.” In *Space Shuttle Technical Conference*. Part 1. NASA CP-2342. Houston, TX: Johnson Space Center, 1983.
- Prandtl, L[udwig]. *General Considerations on the Flow of Compressible Fluids*. Paper presented at the Fifth Convention of the Volta Congress, Italy, September 30 to October 6, 1935. Translated by S. Reiss. NACA TM 805. Washington 1936.
- “Press Kit: Space Shuttle Orbiter Test Flight Series.” Release No. 77-16. Washington, D.C.: NASA, February 4, 1977.
- Ramsey, Sayed. *Tools of War: History of Weapons in Modern Times*. Alpha Editions, 2016.
- Reed, R. Dale, with Darlene Lister. *Wingless Flight: The Lifting Body Story*. Washington, D.C.: NASA, 1997.
- Reimer, Thomas, Markus Kuhn, Ali Gülhan, Burkhard Esser, Martin Sippel, and Arnold van Foreest. *Transpiration Cooling Tests of Porous CMC in Hypersonic Flow*. 17th AIAA Space Planes and Hypersonic

Systems and Technologies Conference, April 11-14, 2011, San Francisco, CA, paper 2011-2251.

Reisert, Donald and Elmor J. Adkins. "Flight and Operational Experience with Pilot-Operated Reaction Controls." Presented at the meeting of the *American Rocket Society* March 13-16, 1961.

Results of the Second U.S. Manned Orbital Space Flight. May 24, 1962, <http://www.hq.nasa.gov/office/pao/History/SP-6/ch1.htm>, accessed July 21, 2013.

Richards, W. Lance. *Finite-Element Analysis of a Mach-8 Flight Test Article Using Nonlinear Contact Elements*. NASA TM 4796. Edwards, CA: NASA Dryden Flight Research Center, 1997.

Richards, W. Lance, Allen R. Parker, William L. Ko, Anthony Piazza, and Patrick Chan. *Application of Fiber Optic Instrumentation*. North Atlantic Treaty Organization-Research and Technology Organization AGARDograph 160 Flight Test Instrumentation Series-Volume 22. SCI 228 RTO/NATO, 2012.

Richards, W. Lance and Richard C. Monaghan. *Analytical and Experimental Verification of a Flight Article for a Mach-8 Boundary-Layer Experiment*. NASA TM 4733. Edwards, CA: NASA Dryden Flight Research Center, 1996.

Rodriguez, Alvaro and Cooper Snapp. "Orbiter Protection System." In *Wings in Orbit: Scientific and Engineering Legacies of the Space Shuttle*. Ed. Helen Lane. Washington, D.C.: NASA, 2001.

Roland, Alex. *Model Research: The National Advisory Committee for Aeronautics, 1915-1958*. Vol. 1. Washington, D.C.: NASA, 1985.

Ross-Nazzari, Jennifer and Dennis Webb. "The Historical Legacy." In *Wings in Orbit: Scientific and Engineering Legacies of the Space Shuttle*. Ed. Helen Lane. Washington, D.C.: NASA, 2001.

Rotundo, Louis. *Into the Unknown: The X-1 Story*. Washington, D.C.: Smithsonian Institution Press, 1994.

Sady, Wojciech. Stanford Encyclopedia of Philosophy. <https://plato.stanford.edu/entries/fleck/>, accessed February 2, 2017.

Saltzman, Edwin J., K. Charles Wang, and Kenneth W. Ilif. *Flight-Determined Subsonic Lift and Drag Characteristics of Seven Lifting-Body and Wing-Body Reentry Vehicle Configurations with Truncated Bases*. AIAA 99-0383. Presented at the 37th AIAA Aerospace Sciences Meeting and Exhibit, Reno, Nevada, January 11-14, 1999.

Saltzman, Edwin J. and Theodore G. Ayers. *Selected Examples of NACA/NASA Supersonic Flight Research*. NASA SP 513. Edwards, CA: NASA Dryden Flight Research Center, 1995.

Sänger, Eugen. *Rocket Flight Engineering*. NASA TT F-223. Washington, D.C.: NASA, 1965.

Sanoj, P. and Balasubramanian Kandasubramanian. *Journal of Composites* Vol. 2014 825607. (March 6, 2014). <http://www.hindawi.com/journals/jcomp/2014/825607/>, accessed March 29, 2015.

Sausser, Brittany. "What's the Deal with Rocket Vibrations?" *MIT Technology Review*, July 15, 2009, <https://www.technologyreview.com/s/414364/whats-the-deal-with-rocket-vibrations/>, accessed November 3, 2016.

Schwartz, John. "NASA's Foam Test Offered a Vivid Lesson in Kinetics." *New York Times*, June 5, 2003, <http://www.nytimes.com/2003/06/05/national/nationalspecial/05SHUT.html>, accessed April 5, 2016.

Scott, C. D., L. P. Murray, and J. D. Milhoan. *Shuttle Elevon Cove Aerodynamic Heating by Internal Flow*. AIAA P-77-757. Presented at the AIAA 12th Thermophysics Conference, Albuquerque, NM, June 27-29, 1977.

Sears, William P. Introduction. *Collected Works of Robert T. Jones*. Washington, D.C.: NASA TM X-3334, 1976.

Shafer, M. F., Smith, R. E., Stewart, J. F., and Bailey, R. E. *Flight Test Experience with Pilot-Induced Oscillation Suppression Filters*. NASA TM 86028. Edwards, CA: NASA Ames-Dryden Flight Research Facility, 1984.

Shapin, Steven. *Science* <http://www.press.uchicago.edu/ucp/books/book/chicago/G/bo25676016.html>, accessed February 2, 2017.

Shortal, Joseph A. *A New Dimension: Wallops Island Flight Test Range: The First Fifteen Years*. Washington, D.C.: NASA, 1978.

Smith, Donald W., Frederick G. Edwards, John D. Foster, and Fred J. Drinkwater III. "Flight Tests of an Automatic Approach and Landing Concept for a Simulated Space Shuttle Represented by the NASA Convair 990 Aircraft." In *Advances in Control Systems* No. 137, May 1, 1974.

Smith, J. W. *Analysis of a Longitudinal Pilot-Induced Oscillation Experienced on the Approach and Landing Test of the Space Shuttle*. NASA TM-81366. Edwards, CA: NASA Ames-Dryden Flight Research Facility, 1981.

Smith, John W. and John W. Edwards. *Design of a Nonlinear Adaptive Filter for Suppression of Shuttle Pilot-induced Oscillation Tendencies*. NASA TM-81349. Edwards, CA: NASA Dryden Flight Research Center, 1980.

"Space Shuttle External Tank Statistics and Comparisons." Lockheed Martin Space Systems Company, Michoud Operations, February 2008.

"Space Shuttle Orbiter Approach and Landing Test – Final Evaluation Report." JSC-13864.

Space Shuttle Transoceanic Abort Landing Sites. NASA Fact Sheet. [n.d.].

Spivey, Natalie D. *High-Temperature Modal Survey of a Hot-Structure Control Surface*. NASA TM 215965. Edwards, CA: NASA Dryden Flight Research Center, 2011.

Stack, John. *The Compressibility Burble*. NACA TN 543. Langley, VA: Langley Memorial Aeronautical Laboratory, 1935.

Stack, John, W. F. Lindsey, and Robert E. Littell. *The Compressibility Burble and the Effect of Compressibility on Pressures and Forces Acting on an Airfoil*. NACA Report No. 646. Langley, VA: Langley Memorial Aeronautical Laboratory, 1938.

Staff. *Experience with the X-15 Adaptive Flight Control System*. NASA TN D-6208. Edwards, CA: NASA Flight Research Center, 1971.

Stallings, D. W. *Wind Tunnel Tests of Elevon Gap Heating on the Space Shuttle Orbiter*. (OH-107) AEDC-TSR-81-V7. Tullahoma, TN: Arnold Air Force Station, 1981.

Stanley, R. M. and R. J. Sandstrom. *Air Force Supersonic Research Airplane XS-1 Report No. 1*, January 9, 1948. [n.p., n.d.]. <http://history.nasa.gov/x1/afsrax.html#intro>, accessed May 6, 2015.

Stillwell, Wendell H. "Studies of Reaction Controls." In *Research Airplane Committee Report on Conference on the Progress of the X-15 Project*. Langley, VA: NACA: October 25-26, 1956.

Stillwell, Wendell H. and Hubert M. Drake. *Simulator Studies of Jet Reaction Controls for Use at High Altitudes*. NACA RM H58G18a. Edwards, CA: NACA High Speed Flight Station, 1958.

Stokes, P. R. "Hydrogen Peroxide for Power and Propulsion." Read at the Science Museum, London, 14 January 1998. http://hydrogen-peroxide.us/history-Germany/hydrogen-peroxide-for-propulsion-and-power_PR_Stokes-1998.pdf, accessed September 24, 2014.

Stoliker, Fred. *Pulling Numbers Out of the Air—Data Processing in the Early 1950s: Performance Engineering Branch, Edwards AFB, California*. Edwards, CA: Air Force Flight Test Center History Office, 1998.

"Street Math, Space Shuttle." NASA Jet Propulsion Laboratory, California Institute of Technology, 2016.

Stüper, J. *Contribution to the Problem of Airfoils Spanning a Free Jet*. TM 796. Luftfahrtforschung. NACA, December 1935.

"Summary of Engineering Data for Republic AP-76 Research Aircraft Under Project 1226 Competition." Republic Report 55WCS-9231-AA, May 6, 1955: 10-11. In Dennis R. Jenkins. *The X-15: Extending the Frontiers of Flight*. Washington, DC: NASA, 2007.

Swenson, Loyd S. Jr., James Grimwood, and Charles C. Alexander. *This New Ocean: A History of Project Mercury*. Washington, D.C.: NASA, 1998.

Test Agency Report ALT GN&C Certification for Free Flights 4 and 5, Volume II, Separation. Rockwell International Space Division: Contract NAS9-14000 IRD SE-639T and RA-281T2, December 1977.

Thompson, Milton O. *At the Edge of Space: The X-15 Flight Program*, Foreword by Neil A. Armstrong. Washington, D.C.: Smithsonian Institution Press, 1992.

_____. "Final Remarks and Future Plans." In *Flight Test Results Pertaining to the Space Shuttlecraft*. NASA TM-X-2101. Edwards, CA: NASA Flight Research Center, 1970.

Thompson, Milton O. and Curtis Peebles. *Flying Without Wings: NASA Lifting Bodies and the Birth of the Space Shuttle*. Washington, D.C.: Smithsonian Institution Press, 1999.

Trimble, William F. *Admiral William A. Moffett: Architect of Naval Aviation*. Washington, D.C.: Smithsonian Institution Press, 1994.

Trujillo, B. M., R., Jr. Meyer and P. M. Sawko. *In-Flight Load Testing of Advanced Shuttle Thermal Protection Systems*. NASA TM-86024. Edwards, CA: NASA Dryden Flight Research Center, 1983.

Tucker, Tom. *The Eclipse Project*. Washington, D.C.: NASA, 2000.

_____. *Touchdown: The Development of Propulsion Controlled Aircraft at NASA Dryden*. Washington, D.C.: NASA, 1999.

Varisco, Angelo, Albin Borysewicz, and Willie Wolter. *Design and Fabrication of Elevation Thermal Protection Systems for Aerospace Vehicles*. CR 159055. Langley, VA: NASA, 1979.

Vincenti, Walter. "Robert Thomas Jones: May 28, 1910-August 11, 1999," <http://www.nap.edu/readingroom.php?book=biomems&page=rjones.html>, accessed August 19, 2013.

Vogel-Prandtl, Johanna. *A Biographical Sketch, Remembrances and Documents*. Translated by V. Vasanta Ram. Trieste: International Centre for Theoretical Physics, 2004.

Walker, Joseph A. "I Fly the X-15." *National Geographic* 122, No. 3 September 1962: 429-450.

_____. "Investigation of Aircraft Control by Use of Reaction of Small Rocket Motors." *Society of Experimental Test Pilots Newsletter*. November 1960. NASA AFRC Historical Reference Collection.

Wallace, Harold D., Jr. *Wallops Station and the Creation of an American Space Agency*. Washington, D.C.: NASA, 1997.

Walter, Hellmuth. *Report on Rocket Power Plants Based on T-Substance*. NACA TM No. 1170. Washington, D.C.: NACA, July 1947.

Waltman, Gene L. *Black Magic and Gremlins: Analog Flight Simulations at NASA's Flight Research Center*. Edwards, CA: NASA Dryden Flight Research Center, 2000.

Wernimont, E., M. Ventura, G. Garboden and P. Mullens. "Past and Present Uses of Rocket Grade Hydrogen Peroxide." http://www.hydrogen-peroxide.us/history-US-General-Kinetics/H2O2_Conf_1999-Past_Present_Uses_of_Rocket_Grade_Hydrogen_Peroxide.pdf, accessed September 23, 2014.

Werrell, Kenneth P. "Those Were the Days: Flying Safety During the Transition to Jets, 1944-1953." *Air Power History* (Winter 2005): 40-53.

White, John S. and Q. Marion Hansen. *Study of Systems Using Inertia Wheels for Precise Attitude Control of a Satellite*. NASA D-691. Moffett Field, CA: Ames Research Center, 1961.

Williams, Walter C. Correspondence to NASA Headquarters. Re: Termination of Programs on the X-1E. May 6, 1959. AFRC Historical Reference Collection.

_____. Correspondence to R. H. Frost, Vice President, Stanley Aviation Corp. June 4, 1959. AFRC Historical Reference Collection.

Williams, Walter C. and Hubert M. Drake. "The Research Airplane: Past, Present, and Future." *Aeronautical Engineering Review*. January 1958.

Willamson, Ray A. "Developing the Space Shuttle." In *Exploring the Unknown: Selected Documents in the History of the U.S. Civil Space Program, Volume IV: Accessing Space*. Edited by John M. Logsdon.

Washington, D.C.: NASA, 1999.

Winter, Frank H., and Frederick I. Ordway with James H. Wyld, John Shesta and Phillippe Cosyn. *Pioneering American Rocketry: The Reaction Motors, Inc. (RMI) Story, 1941-1982*. San Diego: AAS, 2015.

Witkin, Richard. *The Challenge of the Sputniks*. New York: Doubleday Headlines Publications, 1958.

Wong, Thomas J., Charles A. Hermach, John O. Reller, Jr., and Bruce E. Tinling. "Preliminary Studies of Manned Satellites—Wingless Configuration: Lifting Bodies." In *NACA Conference on High-Speed Aerodynamics. A Compilation of Papers Presented*. March 18, 19, and 20, 1958. Moffett Field, CA: NACA Ames Aeronautical Laboratory, 1958.

Wright, Wilbur. "Some Aeronautical Experiments," presented to the Western Society of Engineers, September 18, 1901. *Annual Board of Regents of the Smithsonian Institution, Showing the Operations, Expenditures, and Condition of the Institution for the Year Ending June 30, 1902*. Washington, D.C.: U.S. Government Printing Office, 1903. https://books.google.com/books?id=0_UyAQAAMAAJ&pg=PA133&lpg=PA133&dq=Wilbur+Wright,+%E2%80%9CSome+Aeronautical+Experiments,%E2%80%9D+presented+to+the+Western+Society+of+Engineers,+Sept.+18,+1901&source=bl&ots=I6Z5qGLH1h&sig=bhx6bpDx4k_72wb5awGqfh1_mCA&hl=en&sa=X&ved=0ahUKEwiHn9Oj9sTTAhVG6CYKHAAoBM4Q6AEIPTAG#v=onepage&q=Wilbur%20Wright%2C%20%E2%80%9CSome%20Aeronautical%20Experiments%2C%E2%80%9D%20presented%20to%20the%20Western%20Society%20of%20Engineers%2C%20Sept.%2018%2C%201901&f=false, accessed March 23, 2017.

Yeager, General Chuck and Leo Janos. *Yeager: An Autobiography*. New York: Bantam Books, 1985.

Young, James O. *Meeting the Challenge of Supersonic Flight*. Edwards Air Force Base, CA: Air Force Flight Test Center History Office, 1997.

Zahm, A[ibert] F. "On the Need for an Aeronautical Laboratory in America." *Aero Club of America Bulletin*. February 1912, p. 35. In Alex Roland, *Model Research*, Vol. 1.

_____. "Report of European Aeronautical Laboratories." July 27, 1914. In Zahm, *Aeronautical Papers*. 2 volumes. Notre Dame, IN: University of Notre Dame Press, 1950.

Contributors

Michael R. Chandler served as the Chief, Medical Operations at the Johnson Space Center. He was a fixed-wing and rotary-wing pilot with the U.S. Air Force, and flew missions at Northrup Strip (White Sands Space Harbor) in support of the STS-3 landing. He joined the DoD Manager's Office at Patrick AFB, FL, supporting shuttle missions at the control center and at Transoceanic Abort Landing sites. As Chief of the Training and Exercise Branch, Chandler trained over 1,200 people at 20 different locations in preparation for STS-26R (Return-To-Flight). His awards include a NASA Distinguished Public Service Medal, Astronaut Silver Snoopy Award, Defense Meritorious Service Medal, Air Force Meritorious Service Medals, and Commendation Medal. He holds degrees from Tarleton State University, TX, and Embry-Riddle Aeronautical University, FL.

Gray Creech is a Senior Technology Analyst at NASA's Armstrong Flight Research Center. He first came to NASA to work on the Strategic Communications team. He served in the U.S. Air Force as a B-52 nuclear alert crew chief, on assignments with the B-2 stealth bomber Combined Test Force, and other special access programs performing weapons and platforms test and development. He deployed during the Gulf War in support of U-2 ISR operations. Creech earned a B.A. from Chapman University, and has authored and co-authored technical articles in various publications, including NASA Tech Briefs.

Christian Gelzer taught history at Auburn University before coming to the Armstrong Flight Research Center in 2002, where he serves as the Center's historian. He has authored three books, co-authored or contributed to four, and edited another nine. Gelzer has published in refereed journals and is a regular presenter at conferences and meetings. He holds a Ph.D. from Auburn University in the history of technology and U.S. history and is a pilot.

George Grimshaw was the last Space Shuttle Project and Ground Operations Manager at the Armstrong Flight Research Center. He began working on the space shuttle program in 1979 and supported 103 of the 133 space shuttle missions in a variety of technical, leadership and management roles. He served as a USAF instrument flight instructor on T-37 aircraft simulators, and as an avionics technician with the California Air National Guard and U.S. Air Force Reserve. He holds an MBA from Embry-Riddle Aeronautical University, FL., and is a recipient of the NASA Manned Flight Awareness, Astronauts Personal Achievement Silver Snoopy Award, a Space Flight Awareness Award Honoree, among others.

Peter W. Merlin served as archivist and public affairs officer at the NASA Armstrong Flight Research Center. As a freelance writer, Merlin published articles in a variety of periodicals, covering subjects from aerospace history to nuclear weapons accidents. His books include *Mach 3+: NASA/USAF YF-12 Flight Research, 1969-1979*; *The Smell of Kerosene: A Test Pilot's Odyssey*; *Breaking the Mishap Chain: Human Factors Lessons Learned from Aerospace Accidents in Research Flight Test*, and *Crash Course: Lessons Learned from Accidents Involving Remotely Piloted and Autonomous Aircraft*. He holds a B.S. from Embry-Riddle Aeronautical University and is a member of the Flight Test Historical Foundation and the National Atomic Museum Foundation. A founding member of the X-Hunters Aerospace Archeology Team, he also specializes in recovering historic aircraft artifacts from the southwestern United States.

Curtis Peebles was a widely-published author specializing in aeronautics and Cold War history. He was an independent author before coming to work at the Dryden Flight Research Center in 1997. There, he greatly expanded the existing collection of oral histories while co-authoring *Runway to Orbit: Reflections of a NASA Engineer* with Ken Iliff. He shifted to research and writing, publishing 5 books about the NACA and NASA flight research. He has 15 books to his credit as well as numerous articles in refereed journals.

Richard Shih-Shien Chou served in the U.S. Navy as a flight surgeon. Between 2006 and 2011 he volunteered as an emergency flight surgeon for NASA during shuttle landings at Edwards Air Force Base. He

separated from the Navy in 2012 and took a residency at the University of California, San Francisco, in the department of anesthesia. He continues to serve in the California Air National Guard as a flight surgeon.

Christian Gelzer
Editor

ISBN 978-1-62683-064-6



9 781626 830646



National Aeronautics and Space Administration
Armstrong Flight Research Center
Edwards, CA 93523-0273